

AUTEL MAXISYS

# ADAS

« ADVANCED DRIVER ASSISTANCE SYSTEM »

# CALIBRATION



## ADAS SYSTEMS & PACKAGES

MAXIMIZE YOUR ALIGNMENT AND CALIBRATION OPPORTUNITIES

FOR COLLISION REPAIR, GLASS REPAIR, MECHANICAL REPAIR,  
TIRE DEALERS, MOBILE & CALIBRATION CENTERS, AND DEALERSHIPS

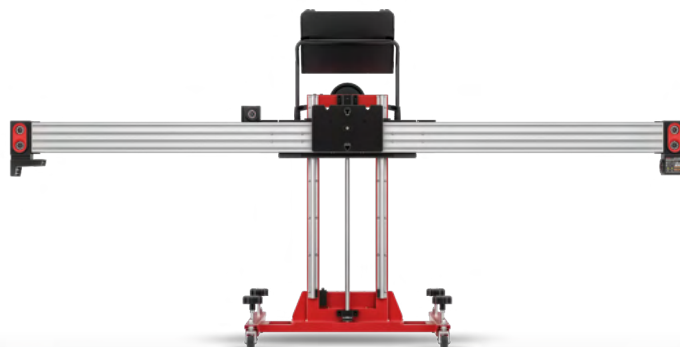

# TABLE OF CONTENTS

**PAGE: 4-5**

ADAS SYSTEMS OVERVIEW

**PAGE: 6-7**

IA900 WHEEL ALIGNMENT & ADAS SYSTEM

**PAGE: 8-9**

IA900 PACKAGES

**PAGE: 10-11**

IA700 ALIGNMENT PRE-CHECK & ADAS SYSTEM

**PAGE: 12-13**

IA700 PACKAGES

**PAGE: 14-15**

IA800 & MA600 ADAS SYSTEMS

**PAGE: 16-17**

ADAS ACCESSORY ITEMS

**PAGE: 18**

PACKAGE SELECTION REFERENCE CHART

**AUTEL ACADEMY  
ADAS TRAINING**

Register today at:  
[autel.cc/training](http://autel.cc/training)



WEB: [AUTEL.COM](http://AUTEL.COM) | SUPPORT: 1.855.288.3587

EMAIL: [USSUPPORT@AUTEL.COM](mailto:USSUPPORT@AUTEL.COM)

FOLLOW US @AUTELTOOLS



## AN INTRO TO ADAS

Advanced driver-assistance systems (ADAS), are technological features that are designed to improve driver safety and prevent automotive accidents. ADAS utilizes sensors such as radar, sonar, lidar and cameras to perceive the world around the vehicle, and either provide critical information to the driver or take automatic action to avoid or mitigate the effects of a crash.

## MAXIMIZE SERVICE PROFITS

ADAS is the fastest growing segment in automotive repair, with 99 million ADAS equipped vehicles already on North American roads and 210 million projected by 2030. ADAS should no longer be considered extra bells and whistles – it's here to stay.

- HAVING YOUR OWN ADAS CALIBRATION SYSTEM SAVES YOU TIME AND MONEY THAT WOULD BE SPENT WORKING WITH ANOTHER SHOP
- IMPROVES CYCLE TIME AND GIVES YOUR SHOP FULL CONTROL OF THE REPAIR
- NO LONGER TRANSPORTING VEHICLES BETWEEN SHOPS INCREASES UP TIME

## ADAS SETUP & REVERSE LOOKUP GUIDE

Use the Autel ADAS Vehicle coverage and calibration guide to quickly reference vehicle make, model, and year for guidance on the calibration pattern, target, or component needed for specific safety system calibration and to view the vehicle-to-target or -component distance requirements.

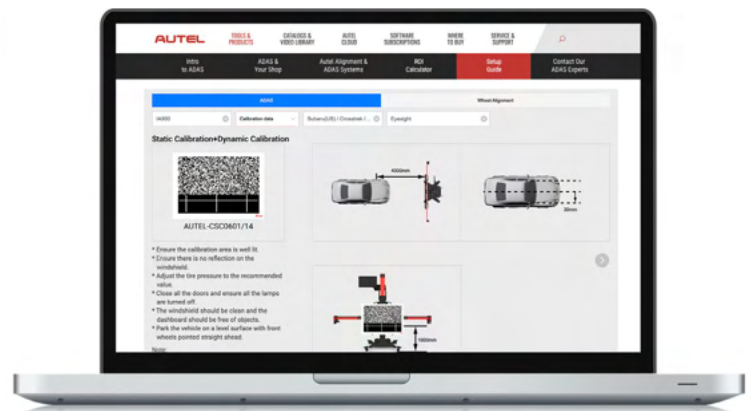

SCAN OR VISIT:  
[AUTEL.CC/ADAS-GUIDE](http://AUTEL.CC/ADAS-GUIDE)



# SHOP BAY REQUIREMENTS

It's a misconception that ADAS calibration requires large amounts of floor space. With Autel ADAS systems, highly profitable LDW calibrations can be performed with as little as 10 feet available in front of the vehicle. Blind Spot and even certain Around View Monitoring calibrations are possible within a 16' x 30' repair bay space with vehicle repositioning, while All Systems ADAS can be performed in a 24' x 34' foot space with limited repositioning of the vehicle.

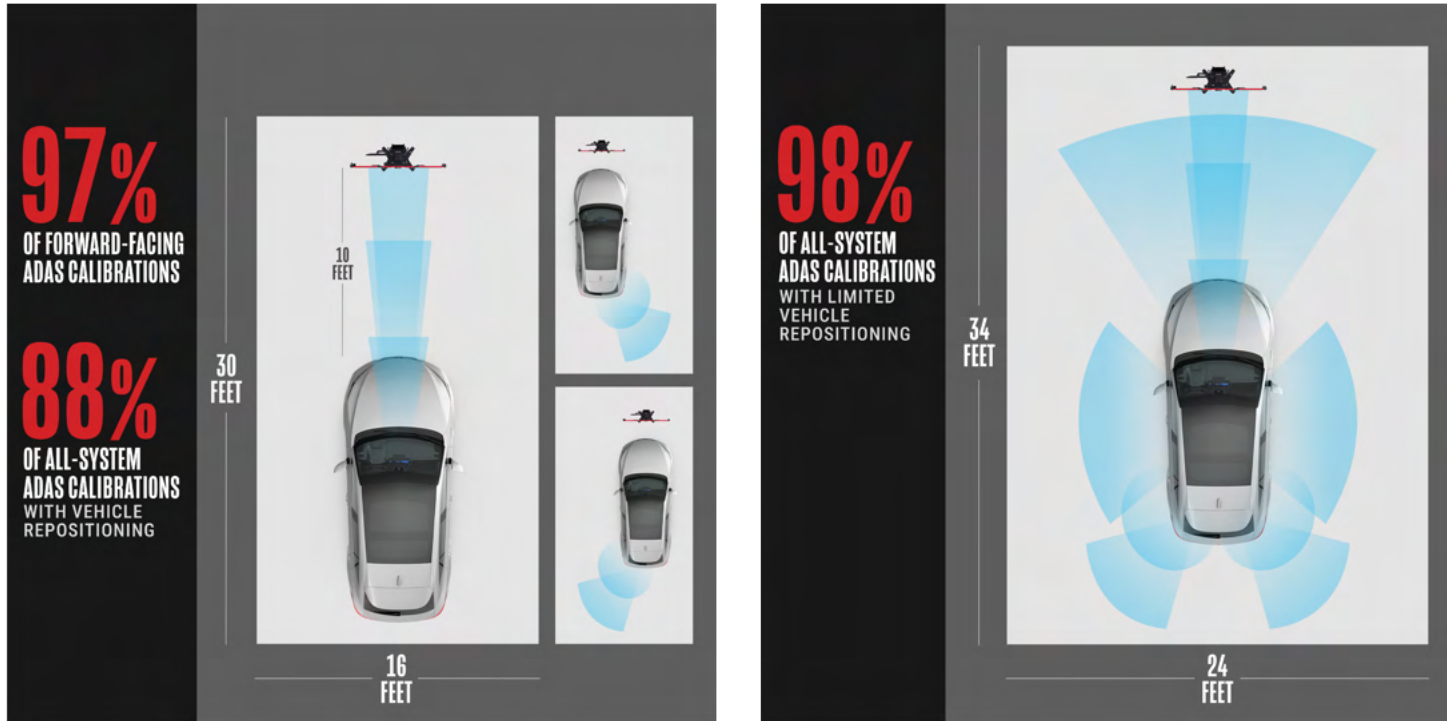

**NOTE:** Spacial requirements for ADAS calibration are defined by the vehicle manufacturer and not the equipment manufacturer.

## ADAS SYSTEM PACKAGES

Autel ADAS System packages are divided into 2 primary groups – Lane Departure Warning (LDW) and All Systems (AS). This approach lets you make the right purchasing decision based on your shop requirements and business goals.

### LANE DEPARTURE WARNING (LDW)

Lane Departure Warning is one of the most common safety features on modern vehicles. LDW calibrations are not only required after many common repairs including wheel alignment and windshield repair, but are also highly profitable.

### ALL SYSTEMS (AS)

All System ADAS packages are designed to eliminate ADAS calibration subletting, give complete control of the entire repair to your business, maximize efficiency and profitability, and deliver new revenue opportunities.

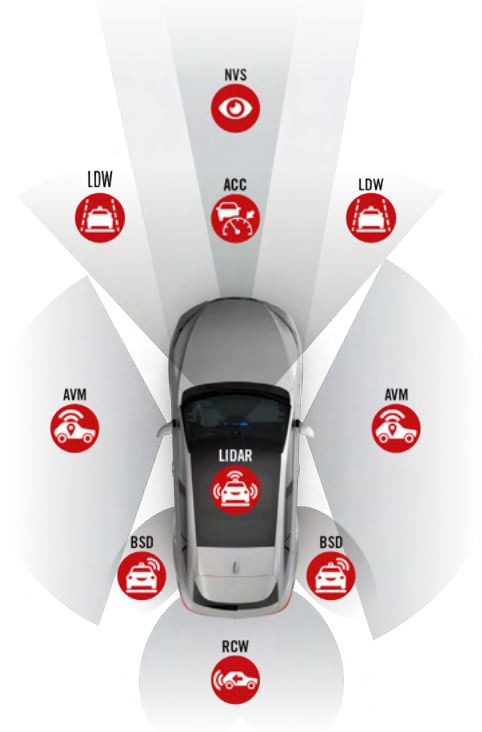

## IA900 ADVANCED ADAS SYSTEM WHEEL ALIGNMENT + ADAS CALIBRATION

For the cost of a typical alignment system, the Autel IA900 delivers an all systems and module health check, digital vehicle inspection, 3D wheel alignment, and step-by-step ADAS calibration instructions in a single system and investment. The Autel IA900 is the only system that starts and finishes through the OBDII connector, beginning with a full health check and digital inspection. These integrated steps deliver the highest revenue potential, the most comprehensive repair, a safer alignment, and a complete calibration of all effected ADAS systems.



**PACKAGE PART NUMBERS:**

- IA900WA - FRAME ONLY
- IA900WAT - FRAME + TABLET
- IA900LDW - FRAME + LDW TARGETS
- IA900LDWT - FRAME + LDW TARGETS + TABLET
- IA900AS - FRAME + ALL SYSTEMS TARGETS
- IA900AST - FRAME + ALL SYSTEMS TARGETS + TABLET

## IA800 OPTICAL POSITIONING SYSTEM ALIGNMENT PRE-CHECK + ADAS CALIBRATION

The Autel IA800 Optical Positioning System features six high-resolution cameras to deliver 3-dimensional adjustment for the most accurate frame centering and vehicle distance recognition. Compatible with your existing Autel Standard Calibration Frame, and designed for seamless integration, this new component system optically measures two-wheel clamp targets to significantly cut down setup time and increase placement precision.

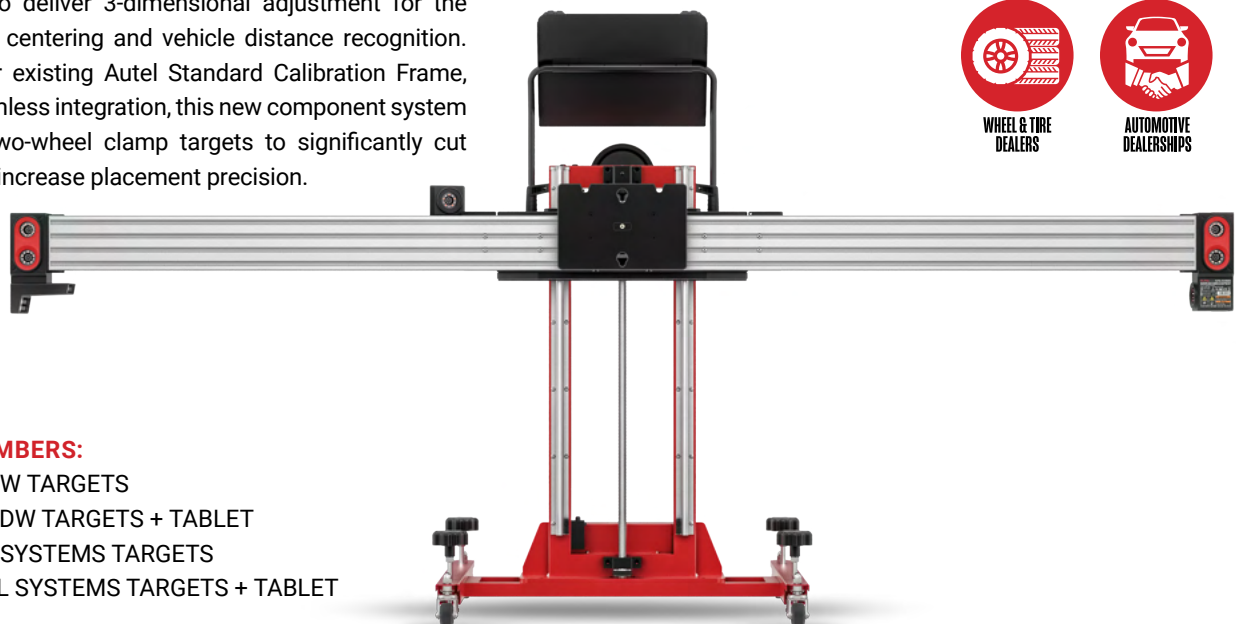

**PACKAGE PART NUMBERS:**

- LDW30 - FRAME + LDW TARGETS
- LDW30T - FRAME + LDW TARGETS + TABLET
- AS30 - FRAME + ALL SYSTEMS TARGETS
- AS30T - FRAME + ALL SYSTEMS TARGETS + TABLET

# IA700 MODULAR ADVANCED ADAS SYSTEM

## ALIGNMENT PRE-CHECK + ADAS CALIBRATION

The Autel IA700 is a state-of-the-art and versatile wheel alignment pre-check and ADAS calibration system engineered for both in-shop and mobile applications – move from bay to bay and shop to shop. It features optical positioning that reduces target setup by 6X versus mechanical measurement, unlevel floor compensation that eliminates failed calibrations due to uneven surfaces, and integrated alignment pre-check in a single system and workflow.

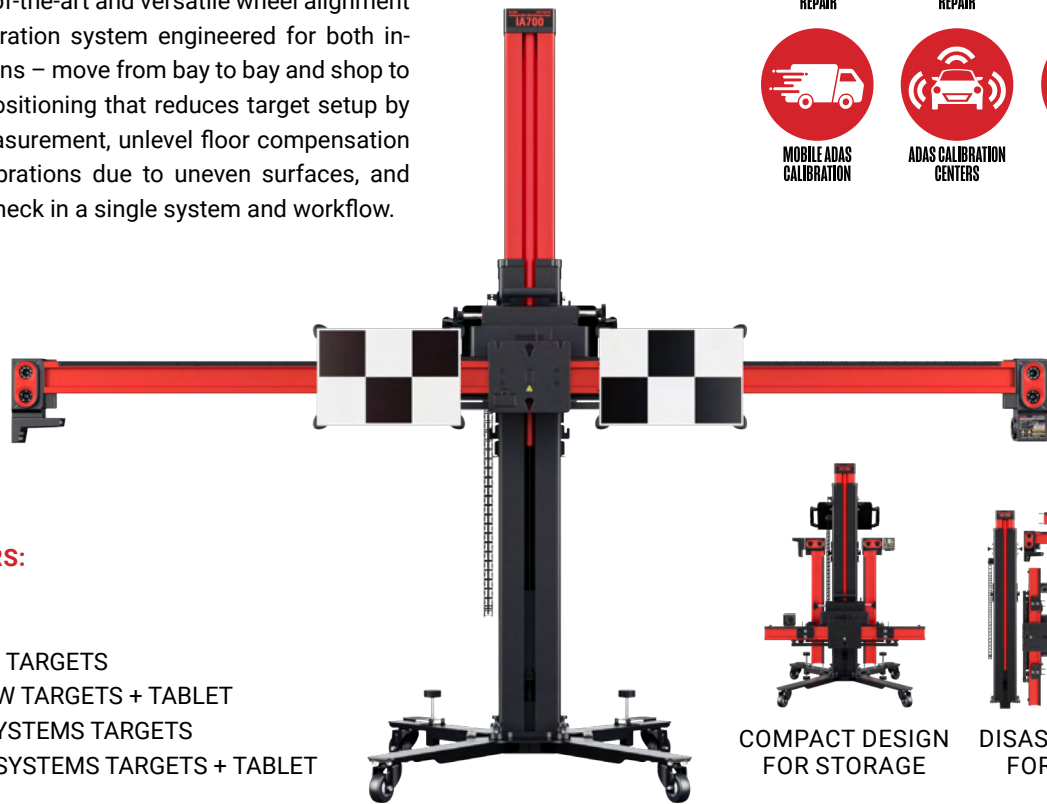

### PACKAGE PART NUMBERS:

- IA700 - FRAME ONLY
- IA700T - FRAME + TABLET
- IA700LDW - FRAME + LDW TARGETS
- IA700LDWT - FRAME + LDW TARGETS + TABLET
- IA700AS - FRAME + ALL SYSTEMS TARGETS
- IA700AST - FRAME + ALL SYSTEMS TARGETS + TABLET

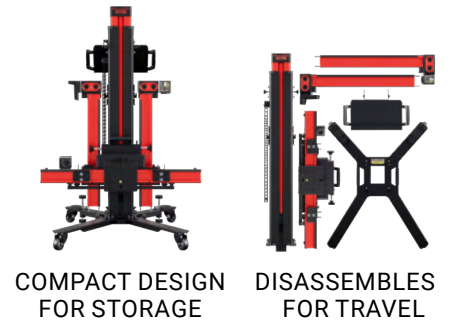

# MA600 ADAS SYSTEM

## PORTABLE ADAS

A Portable ADAS Calibration system that includes a collapsible aluminum calibration frame, 2-line and 5-line centering and aligning lasers, laser-assisted reflectors and Lane Departure Warning (LDW) calibration target set for the calibration of vehicle camera systems. Compatible with the MaxiSYS ADAS tablet, or the MaxiSYS MS906BT or higher tablet series when upgraded with ADAS software (purchased separately).

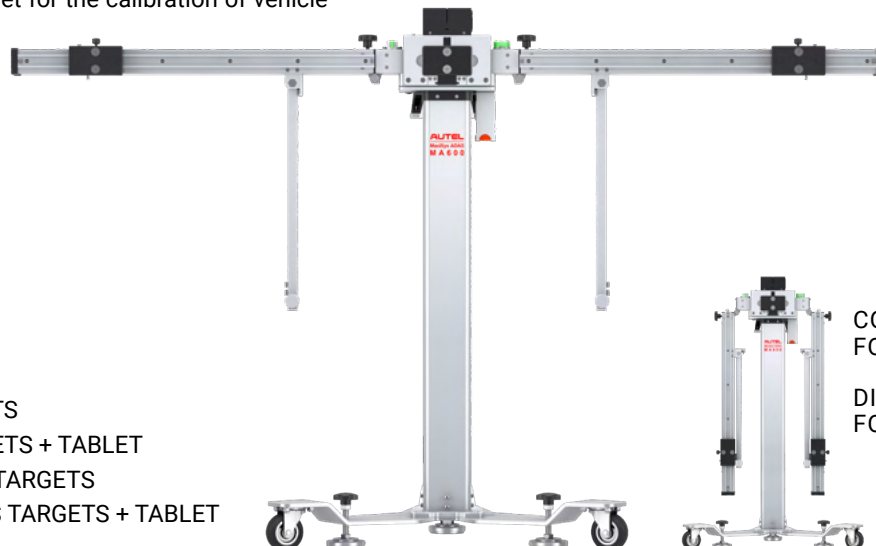

### PACKAGE PART NUMBERS:

- MA60020 - FRAME + LDW TARGETS
- MA60020T - FRAME + LDW TARGETS + TABLET
- MAS20 - FRAME + ALL SYSTEMS TARGETS
- MAS20T - FRAME + ALL SYSTEMS TARGETS + TABLET



AUTEL MAXISYS

# IA900 ADVANCED 3-IN-1 ADAS CALIBRATION SYSTEM

DIAGNOSTICS + WHEEL ALIGNMENT + ADAS CALIBRATION



**ADVANCED  
DIAGNOSTICS**

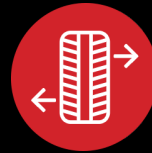

**4-WHEEL  
ALIGNMENT**



**ADAS  
CALIBRATION**

## SINGLE SYSTEM AND WORKFLOW

At the cost of a typical alignment system, the Autel IA900 delivers an All Systems Health Check, Digital Vehicle Inspection, 4-Wheel Alignment, and step-by-step ADAS Calibration instructions in a single system and investment.



## WEBINAR: GETTING OFF THE ADAS SIDELINES: ADAS BUSINESS PLANNING FOR COLLISION CENTERS

An investment into ADAS is still widely considered to be “expensive”, however with the right tools, knowledge and plan, an investment can not only be recouped quickly, but ADAS can become a major revenue generating opportunity for collision repair centers. Don’t just bring this work in-house, become the go-to ADAS calibration service provider in your area.

In this webinar, you will learn how to market your ADAS services to local shops, learn best practices and tips on engineering each repair order to maximize revenue, and gain the confidence to navigate both insurance invoicing and driver-paid repairs and calibrations.

**WATCH THE FULL WEBINAR**  
VISIT [AUTEL.CC/WEBINAR-ADAS-BUSINESS-PLANNING](http://AUTEL.CC/WEBINAR-ADAS-BUSINESS-PLANNING)



## PRECISE OPTICAL MEASUREMENTS

Six high-resolution positioning and tracking cameras in frame.

## INTEGRATED 4-WHEEL ALIGNMENT

Increase shop efficiency and profitability with a single system and workflow.

## AUTOMATIC ROBOTIC CROSSBAR

Cameras automatically locate proper calibration height, even with the vehicle on a lift.



## A COMPLETE ALIGNMENT & ADAS SOLUTION

The Autel ADAS alignment workflow starts with a full Health Check and Digital Inspection. These integrated steps deliver the highest revenue potential, the most comprehensive repair, a safer alignment, and a complete calibration of all effected ADAS systems.

“

*Autel is the only company to offer a total approach, giving you **everything you need for calibration.***

- Gary Machiros

Angie's Service Inc. - Newbury, Massachusetts

”

**IA900** PART NO: IA900WA

- IA900 SYSTEM
- ACCESSORIES
- REQUIRES MAXISYS ULTRA, ADAS & WHEEL ALIGNMENT UPGRADE SOLD SEPARATELY

**IA900+TABLET** PART NO: IA900WAT

- IA900 SYSTEM
- ACCESSORIES
- MAXISYS ULTRA ADAS TABLET & MAXIFLASH VCI
- ADAS & WHEEL ALIGNMENT SOFTWARE INCLUDED

**IA900 LDW PACKAGES**  
EXPANDS LDW CALIBRATION CAPABILITIES

**IA900 LDW** PART NO: IA900LDW

- IA900 SYSTEM
- ACCESSORIES
- LDW TARGETS
- REQUIRES MAXISYS ULTRA, ADAS & WHEEL ALIGNMENT UPGRADE SOLD SEPARATELY

**IA900 LDW+TABLET** PART NO: IA900LDWT

- IA900 SYSTEM
- ACCESSORIES
- LDW TARGETS
- MAXISYS ULTRA ADAS TABLET & MAXIFLASH VCI
- ADAS & WHEEL ALIGNMENT SOFTWARE INCLUDED



MAXISYS ULTRA ADAS VCI

MAXISYS INTELLIGENT ADAS IA900 SYSTEM

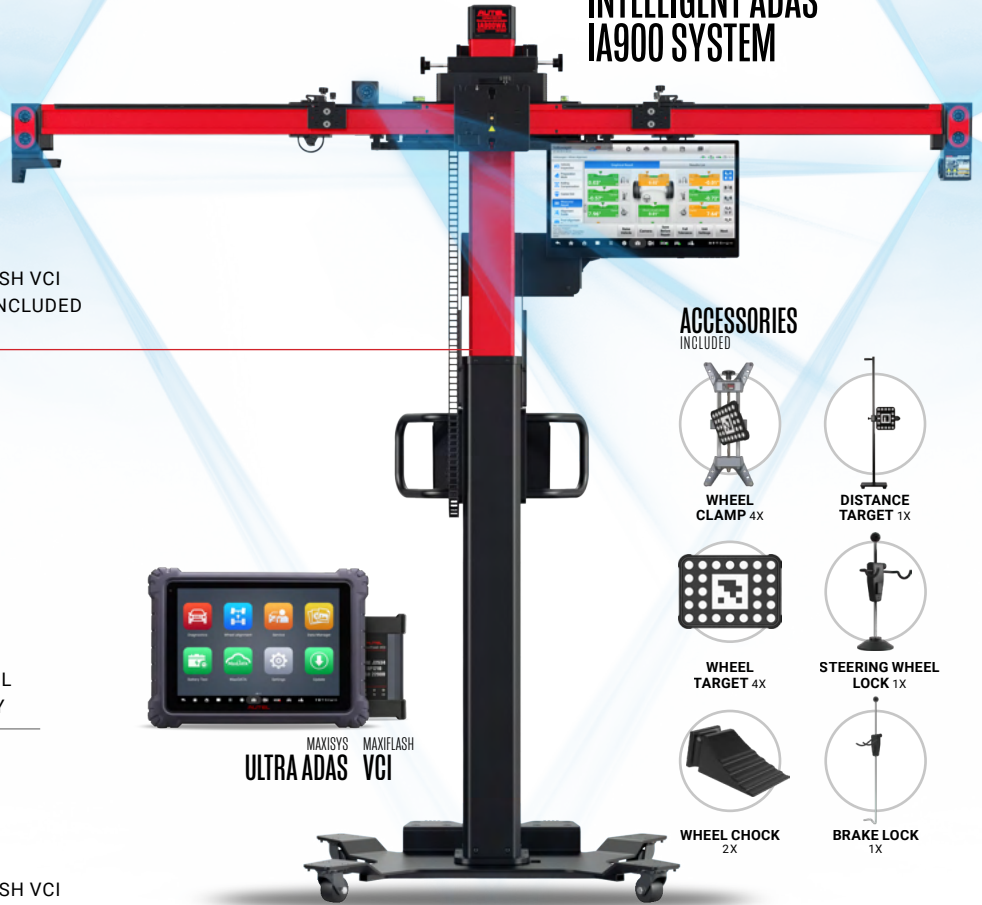

ACCESSORIES INCLUDED



LANE DEPARTURE WARNING

|                                     |                                     |                               |                                       |                                   |                                   |                                   |                                  |
|-------------------------------------|-------------------------------------|-------------------------------|---------------------------------------|-----------------------------------|-----------------------------------|-----------------------------------|----------------------------------|
|                                     |                                     |                               |                                       |                                   |                                   |                                   |                                  |
| VW/AUDI/PORSCHE LDW<br>CSC0601/01   | MERCEDES LDW<br>CSC0601/02          | HONDA/ACURA LDW<br>CSC0601/05 | MAZDA LDW<br>CSC0601/12               | NISSAN LDWII<br>CSC0601/03-L      | NISSAN LDWII<br>CSC0601/03-R      | TOYOTA/LEXUS LDWII<br>CSC0601/15  | HYUNDAI/KIA LDWII<br>CSC0601/07  |
|                                     |                                     |                               |                                       |                                   |                                   |                                   |                                  |
| NISSAN/INFINITI LDW<br>CSC0601/06-L | NISSAN/INFINITI LDW<br>CSC0601/06-R | ALFA ROMEO LDW<br>CSC0601/10  | HONDA/ACURA LDWII<br>CSC0601/08-L     | HONDA/ACURA LDWII<br>CSC0601/08-R | TOYOTA/LEXUS LDWII<br>CSC0601/15  | TOYOTA/LEXUS LDWII<br>CSC0601/15  | SUBARU LDWII<br>CSC0601/17       |
|                                     |                                     |                               |                                       |                                   |                                   |                                   |                                  |
| HYUNDAI/KIA LDW<br>CSC0601/09       | TOYOTA/LEXUS LDW<br>CSC0601/11      | SUBARU LDW<br>CSC0601/14      | MAZDA LDWII<br>CSC0601/13-L           | MAZDA LDWII<br>CSC0601/13-R       | MERCEDES LDWII<br>CSC0601/19      | HONDA/ACURA LDWII<br>CSC0601/24-1 | SUBARU LDWII<br>CSC0601/17       |
|                                     |                                     |                               |                                       |                                   |                                   |                                   |                                  |
| MITSUBISHI LDW<br>CSC0601/22-L      | MITSUBISHI LDW<br>CSC0601/22-R      | SUBARU LDW<br>CSC0601/14      | NISSAN/INFINITI LDWII<br>CSC0601/04-L | NISSAN LDWIII<br>CSC0601/04-R     | TOYOTA/LEXUS LDWIII<br>CSC0601/25 | TOYOTA/LEXUS LDWIII<br>CSC0601/25 | HYUNDAI/KIA LDWIII<br>CSC0701/23 |





# IA900 ALL SYSTEMS PACKAGES

THE ULTIMATE PACKAGES FOR CALIBRATION CAPABILITIES

## IA900 ALL SYSTEMS PART NO: IA900AS

- IA900 SYSTEM
- ACCESSORIES
- LDW, AVM, NVS, ACC, BSD, LIDAR, RCW TARGETS
- REQUIRES MAXISYS ULTRA, ADAS AND WHEEL ALIGNMENT UPGRADE SOLD SEPARATELY

## IA900 ALL SYSTEMS+TABLET PART NO: IA900AST

- IA900 SYSTEM
- ACCESSORIES
- LDW, AVM, NVS, ACC, BSD, LIDAR, RCW TARGETS
- MAXISYS ULTRA ADAS TABLET & MAXIFLASH VCI
- ADAS & WHEEL ALIGNMENT SOFTWARE INCLUDED

### AROUND VIEW MONITORING

|                             |                                |                                |                                   |                                 |                                       |                                     |
|-----------------------------|--------------------------------|--------------------------------|-----------------------------------|---------------------------------|---------------------------------------|-------------------------------------|
|                             |                                |                                |                                   |                                 |                                       |                                     |
| <b>VW AVM</b><br>CSC0804/01 | <b>HONDA AVM</b><br>CSC1004/02 | <b>HONDA AVM</b><br>CSC1004/03 | <b>CADILLAC AVM</b><br>CSC1004/06 | <b>TOYOTA AVM</b><br>CSC1004/10 | <b>HYUNDAI/ KIA AVM</b><br>CSC1004/04 | <b>MITSUBISHI AVM</b><br>CSC1004/09 |

### NIGHT VISION SYSTEM

|   |                                       |  |
|---|---------------------------------------|--|
|   |                                       |  |
| <b>VAG/GM NV CALIBRATOR</b><br>CSC0603/01 | <b>LEXUS NV PATTERN</b><br>CSC0603/03 | <b>MERCEDES NV STAND</b><br>CSC0803/01 |

### ADAPTIVE CRUISE CONTROL

|                                    |  |   |  |                                 |
|------------------------------------|--|---|--|---------------------------------|
|                                    |  |   |  |                                 |
| <b>ACC REFLECTOR</b><br>CSC0602/01 | <b>RADAR CALIBRATION PLATE</b><br>CSC0602/02 | <b>VW ADR CALIBRATION PLATE</b><br>CSC0602/08 | <b>HITACHI RADAR PLATE</b><br>CSC0802/03 | <b>NISSAN AVM</b><br>CSC1004/11 |

### BLIND SPOT DETECTION

|  |  |                                       |                                |                                      |
|--|--|---------------------------------------|--------------------------------|--------------------------------------|
|  |  |                                       |                                |                                      |
| <b>RADAR CALIBRATION BOX</b><br>CSC0605/01 | <b>CORNER REFLECTOR STAND</b><br>CSC0800 | <b>CORNER REFLECTOR</b><br>CSC0802/01 | <b>TARGET STAND</b><br>CSC0802 | <b>HONDA LANEWATCH</b><br>CSC0805/02 |

### LIDAR

|  |   |
|--|---|
|  |   |
| <b>VW/AUDI LIDAR CALIBRATION BOARD</b><br>CSC0602/04 | <b>TOYOTA LIDAR REFLECTOR</b><br>CSC0802/04 |

### REAR COLLISION WARNING

|                              |                                    |                                     |                                  |                                   |
|------------------------------|------------------------------------|-------------------------------------|----------------------------------|-----------------------------------|
|                              |                                    |                                     |                                  |                                   |
| <b>VW RCWI</b><br>CSC0806/01 | <b>MERCEDES RCWI</b><br>CSC1006/01 | <b>MERCEDES RCWII</b><br>CSC1006/02 | <b>NISSAN RCWI</b><br>CSC1006/03 | <b>NISSAN RCWII</b><br>CSC1006/05 |

AUTEL MAXISYS

# IA700 ADVANCED MODULAR ADAS CALIBRATION SYSTEM

DIAGNOSTICS + ALIGNMENT PRE-CHECK + ADAS CALIBRATION



ADVANCED  
DIAGNOSTICS



WHEEL ALIGNMENT  
PRE-CHECK



ADAS  
CALIBRATION

## GUIDED INSTRUCTIONS & OEM PROCEDURES

**Visual Guidance** and easy to follow step-by-step instructions reduce the training learning curve.

**One Stop OEM-sourced Procedures** ensure accurate calibrations and repairs every time.



Compatible with Ultra series tablets. ADAS Upgrade purchase required for new ADAS users.

## CASE STUDY: AUTEL ADAS EQUIPMENT COVERAGE TAKES REPAIR SHOP FROM 10 CALIBRATIONS A MONTH TO OVER 10 A DAY

Fuller's Collision Center in Auburn, Massachusetts is a repair shop that uses Autel ADAS solutions to solve pain points within its business and ramp up revenue via in-house ADAS repairs and calibrations.

The growth of ADAS has created new opportunities and challenges for auto repair shops, changing the landscape of vehicle collision repair. With these challenges come opportunities to increase your services to match the heightened demand for advanced calibrations. Investing in ADAS equipment can help keep jobs in-house, increase revenue, and enable faster ticket turnaround.

Read on to hear how Fuller's Collision used Autel's ADAS solutions to turn around vehicles in eight hours or less, with same-day or next to same-day calibrations, significantly decreasing the shop's cycle time — with no need to outsource to the dealership and lose potential revenue.

**READ THE FULL CASE STUDY**  
VISIT [AUTEL.CC/FULLERSCOLLISION](http://AUTEL.CC/FULLERSCOLLISION)



## FULLY OPTICAL TARGET PLACEMENT

Reduce setup time by 6X versus mechanical measurements.

## UNEVEN FLOOR COMPENSATION

Eliminate failed calibrations due to uneven surfaces.

## INTEGRATED WHEEL ALIGNMENT PRE-CHECK

Ensure your workflow follows OEM-sourced procedures.



**Detachable Crossbar** for storage in tight spaces.



**Quickly Disassembles** in less than 90 seconds for easy transport.



## INDUSTRY-LEADING DIAGNOSTICS & ADAS COVERAGE

**Autel MaxiSYS Scan Tool** featuring advanced diagnostics, secure gateway access, and the Remote Expert platform.

**Industry-leading Vehicle Coverage** for U.S., Asian, and European vehicles.

“

*Autel seemed to stand out to us, and that's why we purchased the systems from them after holding comprehensive meetings to go over all the options and all of our equipment.*

- Mike Ambrosino  
Fuller's Collision Center - Auburn, Massachusetts

”

**IA700** PART NO: IA700

- IA700 SYSTEM
- ACCESSORIES
- REQUIRES MAXISYS ULTRA SERIES TABLET & ADAS UPGRADE SOLD SEPARATELY

**IA700+TABLET** PART NO: IA700T

- IA700 SYSTEM
- ACCESSORIES
- MAXISYS MS909 TABLET & MAXIFLASH VCI
- ADAS & WHEEL ALIGNMENT PRE-CHECK SOFTWARE INCLUDED

MAXISYS  
**INTELLIGENT ADAS  
IA700 SYSTEM**

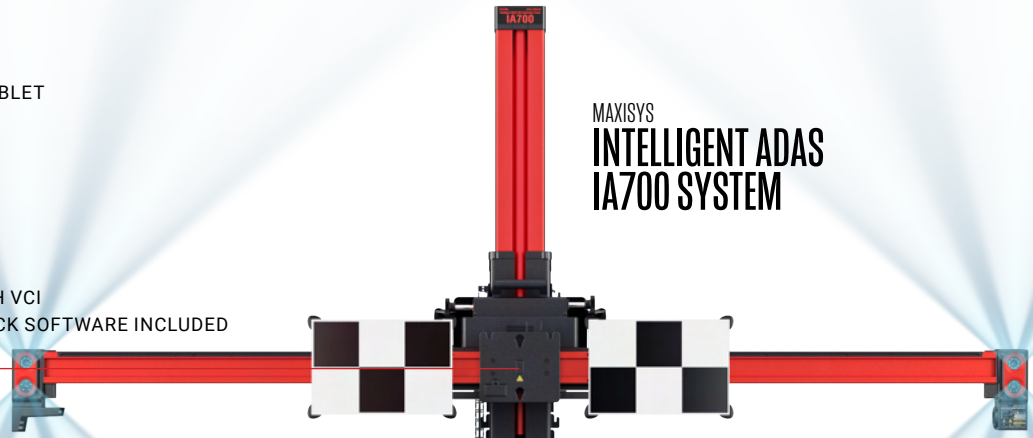

**IA700 LDW PACKAGES**  
EXPANDS LDW CALIBRATION CAPABILITIES

**IA700 LDW** PART NO: IA700LDW

- IA700 SYSTEM
- ACCESSORIES
- LDW TARGETS
- REQUIRES MAXISYS ULTRA SERIES TABLET & ADAS UPGRADE SOLD SEPARATELY

**IA700 LDW+TABLET** PART NO: IA700LDWT

- IA700 SYSTEM
- ACCESSORIES
- LDW TARGETS
- MAXISYS MS909 TABLET & MAXIFLASH VCI
- ADAS & WHEEL ALIGNMENT PRE-CHECK SOFTWARE INCLUDED



**ACCESSORIES  
INCLUDED**



**LANE DEPARTURE WARNING**

|                                       |                                       |                                  |                                  |  |                               |                                   |                                   |   |                                 |
|---------------------------------------|---------------------------------------|----------------------------------|----------------------------------|--|-------------------------------|-----------------------------------|-----------------------------------|---|---------------------------------|
|                                       |                                       |                                  |                                  |  |                               |                                   |                                   |   |                                 |
| VW/AUDI/PORSCHE LDWII<br>CSC0601/01   | MERCEDES LDWII<br>CSC0601/02          | HONDA/ACURA LDWII<br>CSC0601/05  | MAZDA LDWII<br>CSC0601/12        | NISSAN LDWII<br>CSC0601/03-L           | NISSAN LDWII<br>CSC0601/03-R  | HONDA/ACURA LDWII<br>CSC0601/08-L | HONDA/ACURA LDWII<br>CSC0601/08-R | TOYOTA/LEXUS LDWII<br>CSC0601/15                  | HYUNDAI/KIA LDWII<br>CSC0601/07 |
|                                       |                                       |                                  |                                  |  |                               |                                   |                                   |   |                                 |
| NISSAN/INFINITI LDWII<br>CSC0601/06-L | NISSAN/INFINITI LDWII<br>CSC0601/06-R | ALFA ROMEO LDWII<br>CSC0601/10   | MAZDA LDWII<br>CSC0601/13-L      | MAZDA LDWII<br>CSC0601/13-R            | SUBARU LDWII<br>CSC0601/14    | MERCEDES LDWII<br>CSC0601/19      | HONDA/ACURA LDWII<br>CSC0601/24-1 | SUBARU LDWII<br>CSC0601/17                        |                                 |
|                                       |                                       |                                  |                                  |  |                               |                                   |                                   |   |                                 |
| HYUNDAI/KIA LDWII<br>CSC0601/09       | TOYOTA/LEXUS LDWII<br>CSC0601/11      | MITSUBISHI LDWII<br>CSC0601/22-L | MITSUBISHI LDWII<br>CSC0601/22-R | NISSAN/INFINITI LDWIII<br>CSC0601/04-L | NISSAN LDWIII<br>CSC0601/04-R | TOYOTA/LEXUS LDWIII<br>CSC0601/25 | HYUNDAI/KIA LDWIII<br>CSC0701/23  | IA900 ADDITIONAL<br>SLIDER PLATE<br>P/N: IA900STP |                                 |



# IA700 ALL SYSTEMS PACKAGES

THE ULTIMATE PACKAGES FOR CALIBRATION CAPABILITIES

## IA700 ALL SYSTEMS PART NO: IA700AS

- IA700 SYSTEM
- ACCESSORIES
- LDW, AVM, NVS, ACC, BSD, LIDAR, RCW TARGETS
- REQUIRES MAXISYS ULTRA SERIES TABLET
- ADAS UPGRADE SOLD SEPARATELY



## IA700 ALL SYSTEMS+TABLET PART NO: IA700AST

- IA700 SYSTEM
- ACCESSORIES
- LDW, AVM, NVS, ACC, BSD, LIDAR, RCW TARGETS
- MAXISYS MS909 TABLET & MAXIFLASH VCI
- ADAS & WHEEL ALIGNMENT PRE-CHECK SOFTWARE INCLUDED

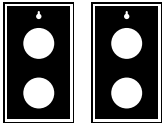
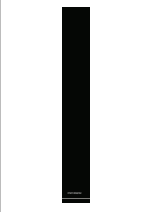
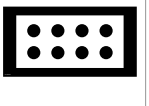
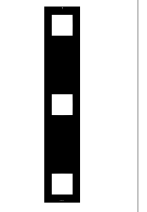
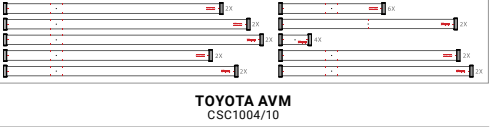
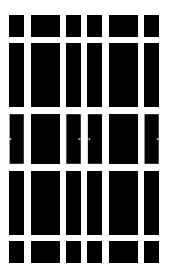
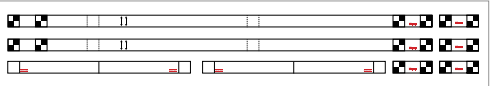

### AROUND VIEW MONITORING

|   |   |   |   |  |   |
|---|---|---|---|--|---|
|  |  |  |  |  |  |
| <b>VW AVM</b><br>CSC0804/01   | <b>HONDA AVM</b><br>CSC1004/02  | <b>HONDA AVM</b><br>CSC1004/03  | <b>CADILLAC AVM</b><br>CSC1004/06   | <b>TOYOTA AVM</b><br>CSC1004/10  |   |
|   |   |   |   |  |   |
|   |   |   |   | <b>HYUNDAI/ KIA AVM</b><br>CSC1004/04  |   |

### NIGHT VISION SYSTEM



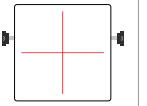

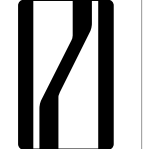
|  |   |  |
|--|---|--|
|  |  |  |
| <b>VAG/GM NV CALIBRATOR</b><br>CSC0603/01  | <b>LEXUS NV PATTERN</b><br>CSC0603/03   | <b>MERCEDES NV STAND</b><br>CSC0803/01   |

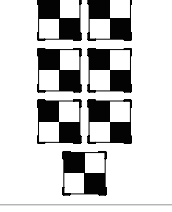
### ADAPTIVE CRUISE CONTROL



|  |  |   |  |
|--|--|---|--|
|  |  |  |  |
| <b>ACC REFLECTOR</b><br>CSC0602/01   | <b>RADAR CALIBRATION PLATE</b><br>CSC0602/02                                       | <b>VW ADR CALIBRATION PLATE</b><br>CSC0602/08                                       | <b>HITACHI RADAR PLATE</b><br>CSC0802/03   |

|  |
|--|
|  |
| <b>NISSAN AVM</b><br>CSC1004/11  |

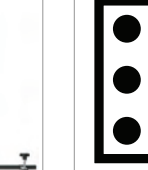
### BLIND SPOT DETECTION

|   |   |   |   |   |
|---|---|---|---|---|
|  |  |  |  |  |
| <b>RADAR CALIBRATION BOX</b><br>CSC0605/01  | <b>CORNER REFLECTOR STAND</b><br>CSC0800  | <b>CORNER REFLECTOR</b><br>CSC0802/01   | <b>TARGET STAND</b><br>CSC0802  | <b>HONDA LANEWATCH</b><br>CSC0805/02  |

### LIDAR

|   |   |
|---|---|
|  |  |
| <b>VW/AUDI LIDAR CALIBRATION BOARD</b><br>CSC0602/04                                  | <b>TOYOTA LIDAR REFLECTOR</b><br>CSC0802/04   |

### REAR COLLISION WARNING

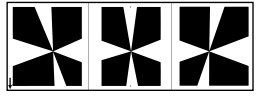
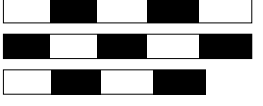
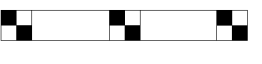
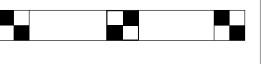
|   |   |   |  |
|---|---|---|--|
|  |  |  |  |
| <b>MERCEDES RCWI</b><br>CSC1006/01  | <b>MERCEDES RCWII</b><br>CSC1006/02   | <b>NISSAN RCWI</b><br>CSC1006/03  | <b>NISSAN RCWII</b><br>CSC1006/05  |

MAXISYS  
IA800 CALIBRATION  
SYSTEM

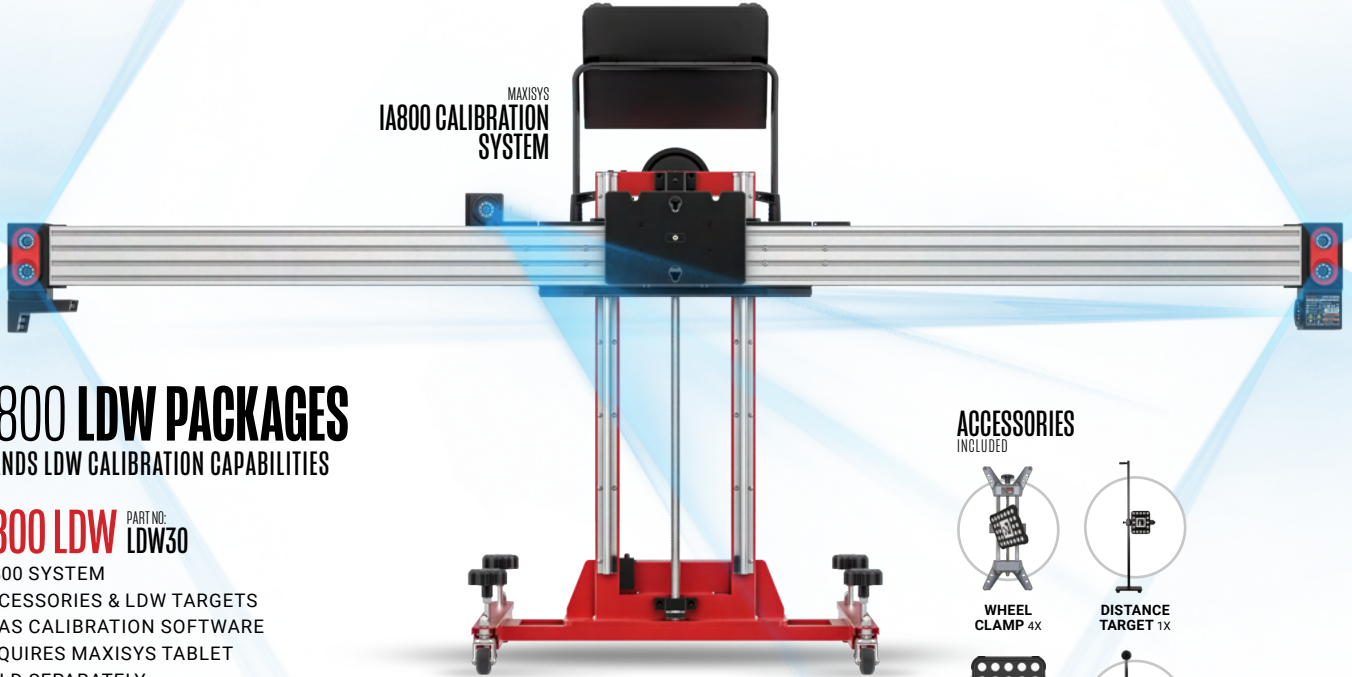

## IA800 LDW PACKAGES

EXPANDS LDW CALIBRATION CAPABILITIES

### IA800 LDW PART NO: LDW30

- IA800 SYSTEM
- ACCESSORIES & LDW TARGETS
- ADAS CALIBRATION SOFTWARE
- REQUIRES MAXISYS TABLET SOLD SEPARATELY

### IA800 LDW +TABLET PART NO: LDW30T

- IA800 SYSTEM
- LDW TARGETS
- ACCESSORIES
- MAXISYS MS909 TABLET
- MAXIFLASH VCI
- ADAS CALIBRATION SOFTWARE

#### ACCESSORIES INCLUDED



WHEEL CLAMP 4X



DISTANCE TARGET 1X



WHEEL TARGET 4X



STEERING 1X

MAXISYS  
MS909  
TABLET



MAXIFLASH  
VCI



## IA800 ALL SYSTEMS PACKAGES

THE ULTIMATE PACKAGES FOR CALIBRATION CAPABILITIES

### IA800 ALL SYSTEMS PART NO: AS30

- IA800 SYSTEM
- ACCESSORIES & LDW, AVM, NVS, ACC, BSD, LIDAR, RCW TARGETS
- ADAS CALIBRATION SOFTWARE
- REQUIRES MAXISYS TABLET

### IA800 ALL SYSTEMS +TABLET PART NO: AS30T

- IA800 SYSTEM
- ACCESSORIES
- LDW, AVM, NVS, ACC, BSD, LIDAR, RCW TARGETS
- MAXISYS MS909 TABLET
- MAXIFLASH VCI
- ADAS CALIBRATION SOFTWARE



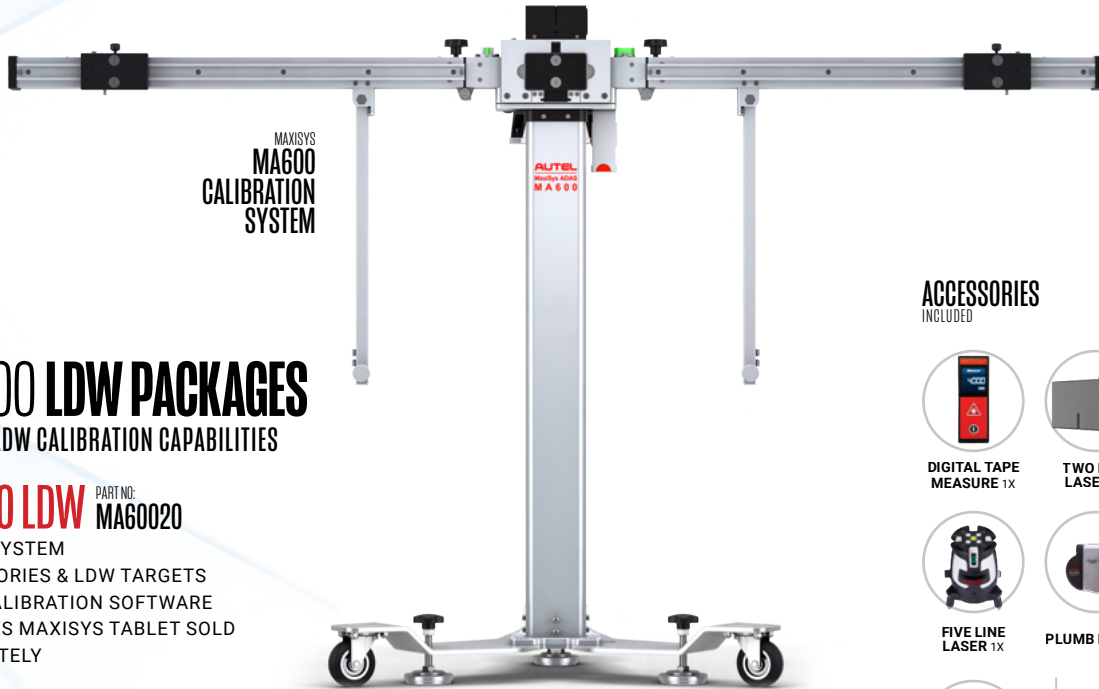

MAXISYS  
MA600  
CALIBRATION  
SYSTEM



## MA600 LDW PACKAGES

EXPANDS LDW CALIBRATION CAPABILITIES

### MA600 LDW PART NO: MA60020

- MA600 SYSTEM
- ACCESSORIES & LDW TARGETS
- ADAS CALIBRATION SOFTWARE
- REQUIRES MAXISYS TABLET SOLD SEPARATELY

### MA600 LDW +TABLET PART NO: MA60020T

- MA600 SYSTEM
- LDW TARGETS
- ACCESSORIES
- MAXISYS MS909 TABLET
- MAXIFLASH VCI
- ADAS CALIBRATION SOFTWARE

MAXISYS  
MS909  
TABLET



### ACCESSORIES INCLUDED



DIGITAL TAPE  
MEASURE 1X



TWO LINE  
LASER 1X



L BRACKET 1X



FIVE LINE  
LASER 1X



PLUMB LINE 1X



LASER  
ASSISTED  
REFLECTOR 1X



LASER  
REFLECTIVE  
BOARD 1X



MOUNTING PLATE 1X  
\*AVAILABLE WITH ALL  
SYSTEM PACKAGES ONLY.



## MA600 ALL SYSTEMS PACKAGES

THE ULTIMATE PACKAGES FOR CALIBRATION CAPABILITIES

### MA600 ALL SYSTEMS PART NO: MAS20

- MA600 SYSTEM
- ACCESSORIES & LDW, AVM, NVS, ACC, BSD, LIDAR, RCW TARGETS
- ADAS CALIBRATION SOFTWARE
- REQUIRES MAXISYS TABLET SOLD SEPARATELY

### MA600 ALL SYSTEMS +TABLET PART NO: MAS20T

- MA600 SYSTEM
- ACCESSORIES
- LDW, AVM, NVS, ACC, BSD, LIDAR, RCW TARGETS
- MAXISYS MS909 TABLET
- MAXIFLASH VCI
- ADAS CALIBRATION SOFTWARE



# ADAS ACCESSORY ITEMS

All items sold separately

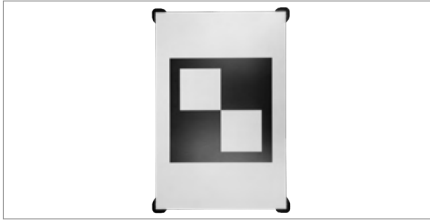

**Subaru Mono Camera Wide Angle LDW Targets (Set of 3)**

**MODEL# CSC0611-05 P/N: 611-05**

Needed for camera calibration on specific trim lines of Subaru Outback, Ascent, Legacy and Crosstrek vehicles. Compatible with all Autel frame systems. Standard, IA800 and IA900 frames require additional slider panel, sold separately.

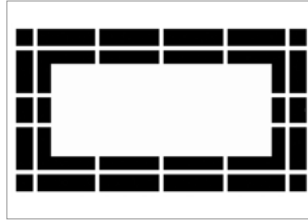

**Porsche AVM Pattern Package**

**P/N: CSC1004-07**

Calibrate AVM Camera systems on equipped Porsche vehicles. This oversized pattern is compatible with Autel ADAS Systems.

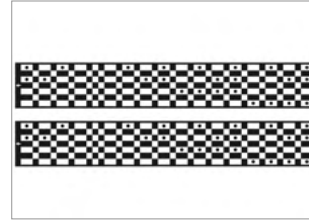

**Ford AVM Pattern Package**

**P/N: CSC1004-05**

Calibrate AVM Camera systems on equipped Ford vehicles. The two-piece pattern is compatible with Autel ADAS Systems.

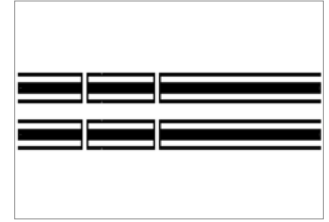

**VW 360 AVM System Pattern Package**

**P/N: CSC1004-01**

Calibrate AVM Camera systems on equipped Volkswagen vehicles. The two-piece pattern is compatible with Autel ADAS Systems.

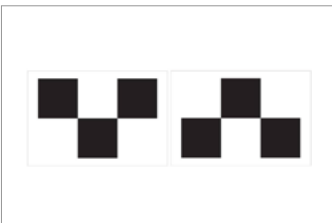

**Maserati LDW Target**  
**MODEL# CSC0611-03**

**P/N: 611-03**

Use to perform static calibration of the applicable Maserati vehicle's front-facing camera. Compatible with the Standard and MA600 systems.



**Ride Height Target**  
**MODEL# CSC0500-20**

**P/N: 500-20**

Enables rapid vehicle wheel height measurement and eliminates the need for manual measurement. Compatible with the IA900 system.

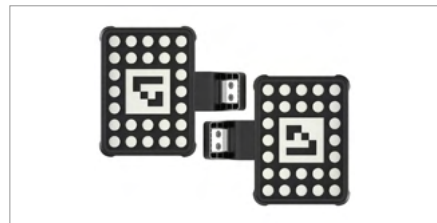

**Wide Angle Target**  
**MODEL# CSC0500-21 P/N: 500-21**

Attaches to wheel targets when target visibility to camera is blocked. Get full chassis measurements after collision. Use when choosing Maximum Steering Angle during the caster/SAI screen. Compatible with the IA900 system.

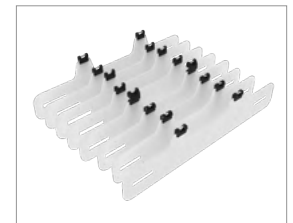

**Audi HUD Calibration Panels (Set Of 8)**

**MODEL# CSC0707**

**P/N: AUDIHUDSET**  
Calibrate the heads-up display (HUD) on older Audi vehicles.

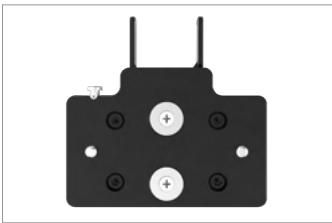

**IA900 Additional Slider Plate**

**P/N: IA900STP**

Replacement sliding Target Panel compatible with the IA900 system.



**Hand-Held Inclinometer**  
**MODEL# CSC0500-29**

**P/N: 500-29**

Aids in a four-wheel alignment of Mercedes-Benz vehicles. Pairs with MaxiSYS tablet and IA900 system.



**IA900 Tire Clamps (Set Of 4)**  
**MODEL# CSC0500-17**

**P/N: 500-17**

Attach to tires rather than to rims. Compatible with IA900 system and existing camera-tracking targets.



**MaxiSYS Ultra ADAS Dock**  
**MODEL# CSC9000-02**

**P/N: IA900DOCK**

Enables power supply to tablet via docking station, allowing the unit to maintain power through operation.

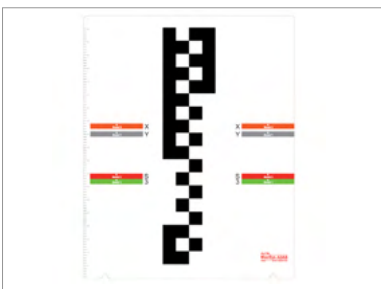

**Tesla LDW Target**  
**MODEL# CSC0611-07 P/N: 611-07**

Calibrates the camera system on Tesla S, X, 3, and Y vehicle models, 4-2019 and newer. Compatible with IA900 and MA600 systems. Requires appropriate Autel Testkit cable to connect to vehicle and tablet's VCI (sold separately).



**ADAS Blind Spot Aiming Tool Kit**

**P/N: ADASBAT**

Enables technicians to quickly ensure correct angle alignments for successful calibrations of the Blind Spot sensors.



**IA900 Storage Cabinet (Tire + Rim)**  
**MODEL# CSC0500-23-T**  
**CSC0500-23-R**

**P/N: 500-23T, P/N: 500-23R**

Metal storage cabinet with wheels for storage of IA900 tire clamps (T) or Rim clamps (R).

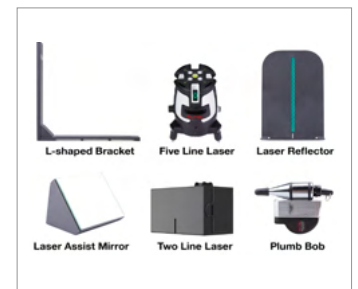

**ADAS Accessory Kit (6 PCS)**  
**P/N: ADASACCESSORY**

This kit is used with Autel ADAS Systems. Enables the technician to perform ADAS calibrations quicker on other special ADAS calibrations.



# ADAS ACCESSORY ITEMS

All items sold separately



**OE sized Corner Reflector Set (STAND)**  
**MODEL# CSC0800**  
 P/N: 800

Includes stand, base, and handle. Use with Autel Corner Reflectors and Laser Emitter.



**OE sized Corner Reflector Set (Laser emitter)**  
**MODEL# CSC0802-13**  
 P/N: 802-13

Battery powered laser emitter, attaches between corner reflector stand and different size corner reflectors.

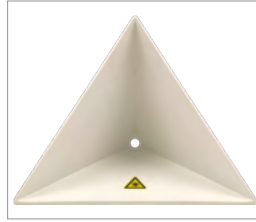

**OE sized Corner Reflector Set (Toyota, Honda US, Subaru Blindspot)**  
**MODEL# CSC0802-10**  
 P/N: 802-10

For radar calibrations involving Toyota, Honda, and Subaru BSM functions.

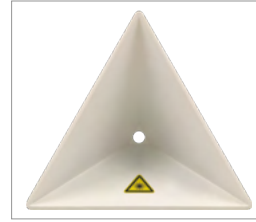

**OE sized Corner Reflector Set (Hyundai, Mazda)**  
**MODEL# CSC0802-11**  
 P/N: 802-11

For radar calibrations involving Hyundai, and Mazda ACC BSM functions.

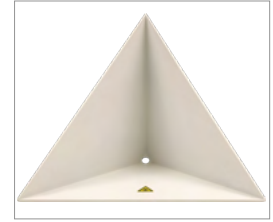

**OE sized Corner Reflector Set (Mitsubishi)**  
**MODEL# CSC0802-12**  
 P/N: 802-12

For radar calibrations involving Mitsubishi BSM functions.



**Wide-Angle Target Extensions for Maximum Steering Angle Caster Sweeps**  
 P/N: WATEXT

For IA900, adapter that extends Wide Angle Targets (CSC0500-21) out even further for max steer procedure, as needed.



**Replacement Claws**  
**MODEL# CSC0500-17-A**  
 P/N: 500-17A

For IA700 IA900 Tire clamps claws replacement, 3 red claws per box, good for 1 wheel.



**Long Claws for Dually Trucks**  
**MODEL# CSC0500-17-B**  
 P/N: 500-17B

For IA700/IA900 Extended tire clamps for dually wheels, 3 red claws per box, good for 1 wheel.



**CHRYSLER TARGET**  
**MODEL# CSC0602-09**  
 P/N: 602-09

Radar Calibration Plate for 2021 and newer Chrysler/Dodge/Jeep/RAM

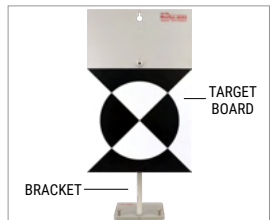

**New AVM Target & Bracket Pack (Toyota, Lexus)**  
**MODEL# CSC0804-03**  
 P/N: 804-03

For Newer Toyota Lexus AVM calibration procedure. 3 minimum required for calibration (up to 12). Sold as EA.

## New PVM Toyota Expansion Pack

**MODEL# CSC1004-10-(D13-D19)** P/N: 1004-10D1319

For Newer Toyota Lexus AVM calibration procedure. *Requires CSC1004\_10 Toyota AVM to work*



**Storage Bracket to Store Large Target Boards**  
**Model# CSC1500-09**  
 P/N: 1500-09

To store Autel ADAS target boards, 3 slots fits multiple sizes.



**Small Brackets for Pattern Board on Standard Frame/IA800**  
**Model# CSC050A-05**  
 P/N: 50A-05

For Autel Standard frame and IA800 frame, allows non magnetic roller ADAS targets to fit on the frame.

Items Introduced Q4 2024

# CHOOSING THE RIGHT ADAS SYSTEM & PACKAGE

## STEP 1. CHOOSE A BASE AUTEL ADAS SYSTEM

Examine the top features and capabilities of each system carefully. Choose the Autel System that best aligns with your business requirements and goals.



| TOP FEATURES  | IA900 | IA700 | IA800 | MA600 |
|---|-------|-------|-------|-------|
| Mobile ADAS System  |       | ✓     |       | ✓     |
| In-Shop ADAS System   | ✓     | ✓     | ✓     |       |
| Wheel Alignment Pre-Check   | ✓     | ✓     | ✓     |       |
| Full Wheel Alignment  | ✓     |       |       |       |
| Mechanical Measurements for Target Placement                            |       |       |       | ✓     |
| Fully Optical Target Placement for Increased Accuracy and Faster Setups | ✓     | ✓     | ✓     |       |
| Unlevel Floor Compensation to Eliminate Uneven Floors as an Obstacle    | ✓     | ✓     |       |       |

## STEP 2. CHOOSE AN AUTEL ADAS SYSTEM PACKAGE

Align the capabilities and opportunities of Lane Departure Warning (LDW) versus All Systems (AS) ADAS with your shop environment and business goals. Choose the Autel System Package that best fits your needs.

|  | IA900     | IA700     | IA800  | MA600    |
|--|-----------|-----------|--------|----------|
| <b>LANE DEPARTURE WARNING (LDW) ADAS PACKAGES</b><br><br><b>COMMON LDW APPLICATIONS &amp; OPPORTUNITIES</b><br>ADAS Calibration for Glass Repair / LDW Calibrations within a 16' x 30' Repair Bay / Scalable Platform: Add All Systems ADAS Later    |           |           |        |          |
| Part Number - Including Tablet   | IA900LDWT | IA700LDWT | LDW30T | MA60020T |
| Part Number - No Tablet  | IA900LDW  | IA700LDW  | LDW30  | MA60020  |
| <b>ALL SYSTEMS (AS) ADAS PACKAGES</b><br><br><b>COMMON ALL SYSTEMS APPLICATIONS &amp; OPPORTUNITIES</b><br>Full Service In-House ADAS Calibration / 98% of All Calibrations within a 24' x 34' Space / Become the ADAS Service Provider in Your Area |           |           |        |          |
| Part Number - Including Tablet   | IA900AST  | IA700AST  | AS30T  | MAS20T   |
| Part Number - No Tablet  | IA900AS   | IA700AS   | AS30   | MAS20    |

## STILL NOT SURE?

Connect with an Autel Expert and schedule a one-on-one ADAS business consultation today

SCAN OR VISIT: [AUTEL.CC/ADASCONTACT](https://www.autel.com/adascontact)



# ADAS BAY MAX LIFT BRING YOUR BAY TO THE MAX



The ADAS Bay Max is a specialized scissor car lift designed for mechanical repair, wheel alignment, and 360-degree ADAS calibration in a single standard bay. It features a robust rolling jack beam, a unique flush-mount H Shape and table riser setup for improved wheel alignments, and can transform into a flat 360-degree ADAS calibration area when recessed into the floor.

Part No. AULS12ALOR1T / AULS14ALOR1T



MECHANICAL REPAIR



WHEEL ALIGNMENT



ALL SYSTEMS ADAS CALIBRATION

READY TO LEARN MORE?  
SCAN OR VISIT [AUTEL.CG/BAYMAXLIFT](http://AUTEL.CG/BAYMAXLIFT)



## AUTEL GUIDED ADAS

ELIMINATE LATE MODEL SOFTWARE LAG

Autel prides itself on the fastest OE-released coverage to market in the industry. Still, we depend on vehicle manufacturers to share the latest model diagnostic, servicing, and calibration software and specifications, which creates a lag time for the newest vehicle coverage to reach our tablets. **Autel Guided ADAS eliminates that lag.**



### SUBSCRIPTIONS AND TOOLS

Pair your existing Autel MaxiSYS tablet, and ADAS frame and targets with a local laptop and OE subscription or an OE tool to calibrate the safety and convenience systems on late model vehicles. Combine the maximized efficiency of Autel optical

positioning with the most current OE coverage. **If OE services are unavailable, the Autel Remote Expert platform enables access to experienced technicians with OE tools or subscriptions to complete the calibration.**



AVAILABLE ON THE IA800, IA900 & IA700  
LEARN MORE AT OUR WEBSITE

## AUTEL REMOTE EXPERT

# ACCESS OE SERVICES RIGHT FROM YOUR AUTEL TOOL



PROGRAM NEW & UPDATE  
EXISTING MODULES

PERFORM OEM  
PRE & POST-SCANS

CALIBRATE ADAS  
ON NEW VEHICLES



EXTENSIVE  
COVERAGE

41 Vehicle Brands  
11 Protocols Supported



100+ VERIFIED  
EXPERTS

Insured & Vetted for Experience  
with Access to OE Software



PROVEN  
EFFICIENCY

4,000 Orders  
Completed Monthly

LEARN MORE ABOUT  
REMOTE EXPERT



# HOW QUICKLY CAN YOU RECOUP YOUR INVESTMENT?

CALCULATE YOUR ADAS REVENUE POTENTIAL ON OUR WEBSITE

The laptop screen shows the 'ROI Calculator' tool with the following data:

| Shop Name | Equipment Investment |
|-----------|----------------------|
|           | \$30,000.00          |

| WHEEL ALIGNMENTS           | ADAS CALIBRATIONS            |
|----------------------------|------------------------------|
| Alignments Per Week: 20    | Calibrations Per Week: 20    |
| Alignment Charge: \$100.00 | Calibration Charge: \$350.00 |

| PRE-SCAN ALL MODULE HEALTH CHECKS | STEERING ANGLE SENSOR RE-LEARNS |
|-----------------------------------|---------------------------------|
| Pre-Scans Per Week: 20            | Re-Learns Per Week: 20          |
| Pre-Scan Charge: \$125.00         | Re-Learn Charge: \$75.00        |

| YOUR RETURN ON INVESTMENT (ROI) |                 |                |                     |
|---------------------------------|-----------------|----------------|---------------------|
| Weekly Revenue                  | Monthly Revenue | Annual Revenue | Full Payback Within |
| \$11,200.00                     | \$44,800.00     | \$537,600.00   | 2.68 Weeks          |

Depending on the number of ADAS sensors on the vehicle, multiple calibrations may be required following an alignment.

Complete Autel reporting, diagnostics, repair, alignment, and ADAS solutions can recoup your investment in as little as 30 days\*.

\*Return on investment varies based on service volume.

**RECOUP YOUR INVESTMENT IN AS LITTLE AS 30 DAYS\***  
SCAN OR VISIT: [AUTEL.CC/ADAS-ROI](http://AUTEL.CC/ADAS-ROI)



## AUTEL ACADEMY ADAS TRAINING

Comprehensive in-person classroom and technical ADAS training now available. This 2-day course is intended for current and future owners of Autel ADAS calibration equipment.

Register today at: [autel.cc/training](http://autel.cc/training)



WEB: [AUTEL.COM](http://AUTEL.COM) | SUPPORT: 1.855.288.3587  
EMAIL: [USSUPPORT@AUTEL.COM](mailto:USSUPPORT@AUTEL.COM)

FOLLOW US @AUTELTOOLS  
   



**AUTEL**