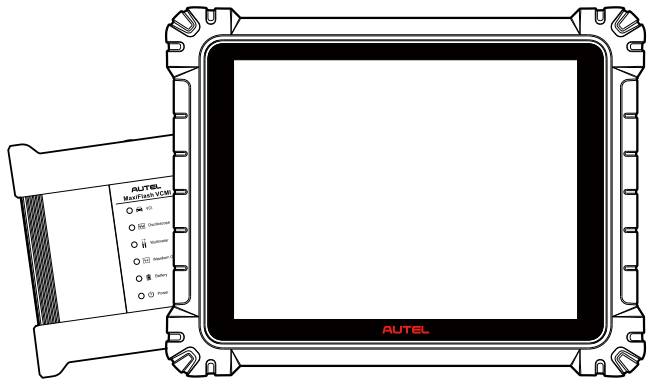


MaxiSys Ultra



Trademarks

Autel®, MaxiSys®, MaxiDAS®, MaxiScan®, MaxiTPMS®, MaxiRecorder®, and MaxiCheck® are trademarks of Autel Intelligent Technology Corp., Ltd., registered in China, the United States, and other countries. All other marks are trademarks or registered trademarks of their respective holders.

Copyright Information

No part of this manual may be reproduced, stored in a retrieval system or transmitted in any form or by any means electronic, mechanical, photocopying, recording, or otherwise without the prior written permission of Autel.

Disclaimer of Warranties and Limitation of Liabilities

All information, specifications and illustrations in this manual are based on the latest information available at the time of printing.

Autel reserves the right to make changes at any time without notice. While information of this manual has been carefully checked for accuracy, no guarantee is given for the completeness and correctness of the contents, including but not limited to the product specifications, functions, and illustrations.

Autel will not be liable for any direct, special, incidental, or indirect damages, or for any economic consequential damages (including the loss of profits) as a result of using this product.

IMPORTANT

Before operating or maintaining this unit, please read this manual carefully, paying extra attention to the safety warnings and precautions.

For Services and Support



pro.autel.com

www.autel.com



1-855-288-3587 (North America)

+86 (0755) 8614-7779 (China)



support@autel.com

For technical assistance in all other markets, please refer to *Technical Support* in this manual.

Safety Information

For your own safety and the safety of others, and to prevent damage to the device and vehicles upon which it is used, it is important that the safety instructions presented throughout this manual be read and understood by all persons operating or coming into contact with the device.

There are numerous procedures, techniques, tools, and parts required for servicing vehicles, as well as the skills of the person doing the work. Because of the vast number of test applications and variations in the products that can be tested with this equipment, we cannot possibly anticipate or provide advice or safety messages to cover every circumstance. It is the automotive technician's responsibility to be knowledgeable of the system being tested. It is crucial to use proper service methods and test procedures. It is essential to perform tests in an appropriate and acceptable manner that does not endanger your safety, the safety of others in the work area, the device being used, or the vehicle being tested.

Before using the device, always refer to and follow the safety messages and applicable test procedures provided by the manufacturer of the vehicle or equipment being tested. Use the device only as described in this manual. Be sure to read, understand, and follow all safety messages and instructions in this manual.

Safety Messages

Safety messages are provided to help prevent personal injury and equipment damage. All safety messages are introduced by a signal word indicating the hazard level.

DANGER

Indicates an imminently hazardous situation which, if not avoided, could result in death or serious injury to the operator or to bystanders.

WARNING

Indicates a potentially hazardous situation which, if not avoided, could result in death or serious injury to the operator or to bystanders.

Safety Instructions

The safety messages herein cover situations Autel is aware of at the time of publication. Autel cannot know, evaluate or advise you as to all of the possible hazards. You must be certain that any condition or service procedure encountered does not jeopardize your personal safety.

 **DANGER**

When an engine is operating, keep the service area WELL VENTILATED or attach a building exhaust removal system to the engine exhaust system. Engines produce carbon monoxide, an odorless, poisonous gas that causes slower reaction time and can lead to serious personal injury or loss of life.

 **It is not advised to use headphones at a high volume**

Listening at high volumes for long periods of time may result in loss of hearing.

 **Safety Warnings**

- Always perform automotive testing in a safe environment.
- Wear safety eye protection that meets ANSI standards.
- Keep clothing, hair, hands, tools, test equipment, etc. away from all moving or hot engine parts.
- Operate the vehicle in a well-ventilated work area, for exhaust gases are poisonous.
- Put the transmission in PARK (for automatic transmission) or NEUTRAL (for manual transmission) and make sure the parking brake is engaged.
- Put blocks in front of the drive wheels and never leave the vehicle unattended while testing.
- Be extra cautious when working around the ignition coil, distributor cap, ignition wires and spark plugs. These components create hazardous voltages when the engine is running.
- Keep a fire extinguisher suitable for gasoline, chemical, and electrical fires nearby.
- Do not connect or disconnect any test equipment while the ignition is on or the engine is running.
- Keep the test equipment dry, clean, free from oil, water or grease. Use a mild detergent on a clean cloth to clean the outside of the equipment as necessary.
- Do not drive the vehicle and operate the test equipment at the same time. Any distraction may cause an accident.
- Refer to the service manual for the vehicle being serviced and adhere to all diagnostic procedures and precautions. Failure to do so may result in personal injury or damage to the test equipment.
- To avoid damaging the test equipment or generating false data, make sure the vehicle battery is fully charged and the connection to the vehicle DLC is clean and secure.
- Do not place the test equipment on the distributor of the vehicle. Strong electromagnetic interference can damage the equipment.

CONTENTS

1	USING THIS MANUAL	1
1.1	CONVENTIONS	1
1.1.1	Bold Text	1
1.1.2	Notes and Important Messages	1
1.1.3	Hyperlink	1
1.1.4	Illustrations	2
1.1.5	Procedures	2
2	GENERAL INTRODUCTION	3
2.1	MAXISYS TABLET	3
2.1.1	Function Description	3
2.1.2	Docking Station	5
2.1.3	Power Sources	6
2.1.4	Technical Specifications	7
2.2	MAXIFLASH VCMI — VEHICLE COMMUNICATION AND MEASUREMENT INTERFACE	8
2.2.1	Function Description	8
2.2.2	Power Sources	12
2.2.3	Technical Specifications	12
2.3	ACCESSORIES KIT	13
2.3.1	Main Cable	13
2.3.2	OBDI-Type Adapters (Optional)	13
2.4	OTHER ACCESSORIES	14
3	GETTING STARTED	15
3.1	POWER UP	15
3.1.1	Application Buttons	16

3.1.2	Locator and Navigation Buttons.....	18
3.1.3	System Status Icons.....	19
3.2	POWER DOWN.....	20
3.2.1	Reboot System.....	20
4	DIAGNOSTICS.....	21
4.1	ESTABLISH VEHICLE COMMUNICATION AND SELECTION.....	21
4.1.1	Establish Vehicle Communication.....	21
4.2	GETTING STARTED.....	26
4.2.1	Vehicle Menu Layout.....	26
4.3	VEHICLE IDENTIFICATION.....	28
4.4	NAVIGATION.....	31
4.4.1	Diagnostics Screen Layout.....	31
4.4.2	Screen Messages.....	34
4.5	DIAGNOSTICS MENU.....	34
4.6	DIAGNOSTICS FUNCTIONS.....	35
4.6.1	ECU Information.....	40
4.6.2	Trouble Codes.....	40
4.6.3	Live Data.....	42
4.6.4	Active Test.....	49
4.6.5	Special Functions.....	50
4.7	PROGRAMMING AND CODING.....	50
4.7.1	Coding.....	51
4.7.2	Reprogramming.....	52
4.7.3	Re-flash Errors.....	52
4.8	GENERIC OBDII OPERATIONS.....	53
4.8.1	General Procedure.....	53

4.8.2	Function Descriptions	54
4.9	DIAGNOSTIC REPORT	57
4.9.1	Pre-Scan and Post-Scan Functions.....	57
4.9.2	Diagnostics Report Saving, Viewing, and Sharing.....	58
4.10	EXIT DIAGNOSTICS	61
5	SERVICE	63
5.1	OIL RESET SERVICE	63
5.2	ELECTRIC PARKING BRAKE (EPB) SERVICE.....	64
5.2.1	EPB Safety	64
5.3	TIRE PRESSURE MONITORING SYSTEM (TPMS) SERVICE	65
5.4	BATTERY MANAGEMENT SYSTEM (BMS) SERVICE	65
5.5	DIESEL PARTICLE FILTER (DPF) SERVICE	65
5.6	IMMOBILIZER (IMMO) SERVICE.....	66
5.7	STEERING ANGLE SENSOR (SAS) SERVICE	67
6	ADAS.....	68
7	MEASUREMENT.....	69
7.1	OSCILLOSCOPE	69
7.1.1	Safety Information	69
7.1.2	General Introduction	71
7.1.3	Getting Started	76
7.1.4	Oscilloscope Update.....	77
7.1.5	Screen Layout and Operations	79
7.1.6	Troubleshooting.....	135
7.1.7	Glossary	136
7.2	MULTIMETER.....	137
7.2.1	Safety Information	137

7.2.2	General Introduction	138
7.2.3	Getting Started	141
7.2.4	Multimeter Update	142
7.2.5	Screen Layout and Operations	143
7.2.6	Troubleshooting.....	160
7.2.7	Glossary	161
7.2.8	Safety Information	162
7.2.9	General Introduction	162
7.2.10	Getting Started	165
7.2.11	Waveform Generator Update.....	165
7.2.12	Screen Layout and Operations	167
7.2.13	Troubleshooting.....	186
7.2.14	Glossary	187
7.3	BUS INSPECTION	187
7.3.1	Safety Information	188
7.3.2	General Introduction	188
7.3.3	Bus Inspection	190
7.3.4	Screen Layout and Operations	191
7.3.5	Troubleshooting.....	213
7.3.6	Glossary	213
8	DATA MANAGER	215
8.1	VEHICLE HISTORY	217
8.1.1	Historical Test Record	218
8.2	WORKSHOP INFORMATION.....	219
8.3	CUSTOMER.....	220
8.4	IMAGE	221

8.5	CLOUD REPORT	222
8.6	PDF FILES	222
8.7	REVIEW DATA	223
8.8	DATA LOGGING	223
8.9	UNINSTALL APPS.....	224
9	BATTERY TEST	225
9.1	MAXIBAS BT506 BATTERY TESTER	226
9.1.1	Function Description	226
9.1.2	Power Sources	227
9.1.3	Technical Specifications	227
9.2	TEST PREPARATION	228
9.2.1	Inspect the Battery	228
9.2.2	Connect the Battery Tester	228
9.3	IN-VEHICLE TEST	229
9.3.1	Battery Test	231
9.3.2	Starter Test	233
9.3.3	Generator Test	234
9.4	OUT-VEHICLE TEST	235
9.4.1	Test Procedure	235
9.4.2	Test Results.....	236
10	SETTINGS.....	237
10.1	UNIT	237
10.2	LANGUAGE	238
10.3	PRINT SETTINGS	238
10.3.1	Printing Operations	238
10.4	REPORT SETTINGS	239

10.5	PUSH NOTIFICATION	239
10.6	AUTO UPDATE	240
10.7	ADAS SETTINGS	240
10.8	VEHICLE LIST	241
10.9	EVDIAG BOX SETTINGS	241
10.10	AUTOVID SETUP	241
10.11	COUNTRY/REGION CODE	242
10.12	SYSTEM SETTINGS	242
10.13	ABOUT	242
11	UPDATE	243
12	VCMI MANAGER	244
12.1	WI-FI CONNECTION	245
12.2	VCMI BLUETOOTH PAIRING	246
12.3	BAS BLUETOOTH PAIRING	247
12.4	VCMI UPDATE.....	247
12.5	BAS UPDATE	248
13	SUPPORT	249
13.1	SUPPORT SCREEN LAYOUT	249
13.2	MY ACCOUNT	249
13.2.1	Personal Information.....	250
13.2.2	Update Information	250
13.2.3	Service Information.....	250
13.3	TRAINING	250
13.4	DATA LOGGING	250
13.5	FAQ.....	251
14	MAXVIEWER.....	252

15	MAXIVIDEO	255
16	QUICK LINK	256
17	REMOTE DESKTOP	257
17.1	OPERATIONS	257
18	USER FEEDBACK	259
19	AUTEL USER CENTER	260
20	MAINTENANCE AND SERVICE	262
20.1	MAINTENANCE INSTRUCTIONS	262
20.2	TROUBLESHOOTING CHECKLIST	263
20.3	ABOUT BATTERY USAGE	263
20.4	SERVICE PROCEDURES	264
20.4.1	Technical Support	264
20.4.2	Repair Service	266
20.4.3	Other Services	267
21	COMPLIANCE INFORMATION	268
22	WARRANTY	270

1 Using This Manual

This manual contains device usage instructions.

Some illustrations shown in this manual may contain modules and optional equipment that are not included in your system.

1.1 Conventions

The following conventions are used:

1.1.1 Bold Text

Bold text is used to highlight selectable items such as buttons and menu options.

Example:

- Tap **OK**.

1.1.2 Notes and Important Messages

1.1.1.1 *Notes*

A **NOTE** provides helpful information such as additional explanations, tips, and comments.

1.1.1.2 *Important*

IMPORTANT indicates a situation that if not avoided may result in damage to the tablet or vehicle.

1.1.3 Hyperlink

Hyperlinks are available in electronic documents. Blue italic text indicates a selectable hyperlink; blue underlined text indicates a website link or an email address link.

1.1.4 Illustrations

Illustrations used in this manual are samples, the actual testing screen may vary for each vehicle being tested. Observe the menu titles and on-screen instructions to make correct option selection.

1.1.5 Procedures

An arrow icon indicates a procedure. Example:

- **To power down the MaxiSys tablet**
 1. Long press (press and hold) the **Power/Lock** button.
 2. Tap the **Power Off** option.
 3. Tap **OK**.

2 General Introduction

There are two main components to the MaxiSys system:

- MaxiSys Tablet — the central processor and monitor for the system.
- MaxiFlash VCMI — Vehicle Communication and Measurement Interface.

This manual describes the construction and operation of these devices and how they work together to deliver diagnostic solutions.

2.1 MaxiSys Tablet

2.1.1 Function Description

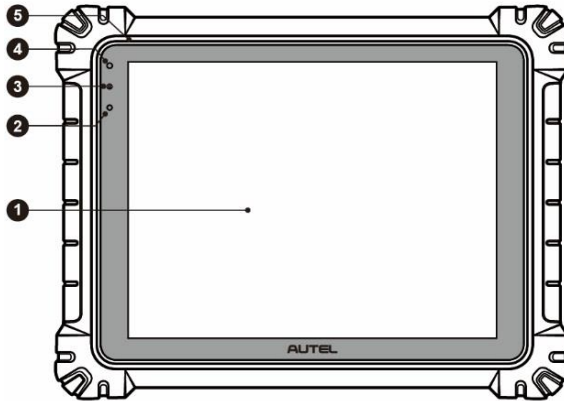


Figure 2-1 MaxiSys Tablet Front View

1. 12.7" TFT-LCD Capacitive Touchscreen
2. Ambient Light Sensor — detects ambient brightness
3. Power LED — refer to [Table 2-1 Power LED Description](#) for details
4. Front Camera
5. Built-in Microphone

Table 2-1 Power LED Description

LED	Color	Description
Power	Green	<ul style="list-style-type: none">• Lights green when the tablet is charging and the battery level is above 90%.• Lights green when the tablet is powered on and the battery level is above 15%.
	Yellow	Lights yellow when the tablet is charging and the battery level is below 90%.
	Red	<ul style="list-style-type: none">• Lights red when the tablet is powered on and the battery level is below 15%.• Lights red when the tablet shows abnormality after being powered on or during charging.

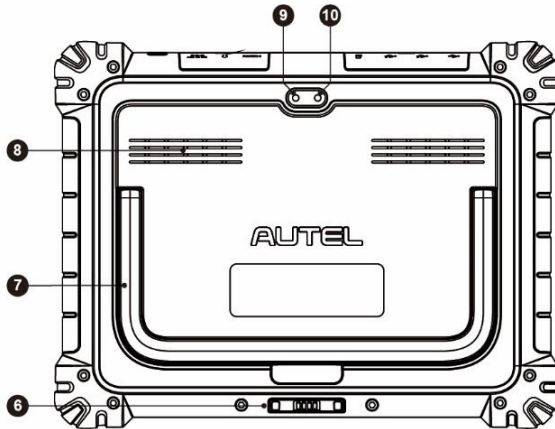


Figure 2-2 MaxiSys Tablet Back View

6. Docking Station Port
7. Collapsible Stand — extends from the back to allow hands-free viewing of the tablet
8. Speaker
9. Rear Camera
10. Camera Flash

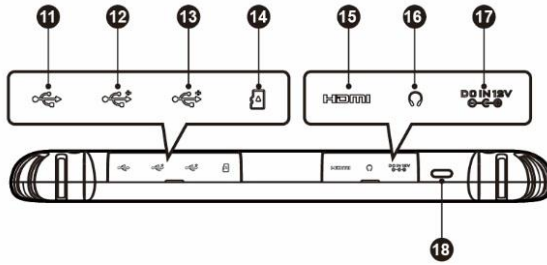


Figure 2-3 MaxiSys Tablet Top View

- 11. Mini USB Port — cannot be used with the USB Port simultaneously
- 12. USB Port
- 13. USB Port
- 14. Mini SD Card Slot
- 15. HDMI (High-Definition Multimedia Interface) Port
- 16. Head Phone Jack
- 17. DC Power Supply Input Port
- 18. Power/Lock Button — long press to turn on/off the tablet; short press to lock the screen

2.1.2 Docking Station

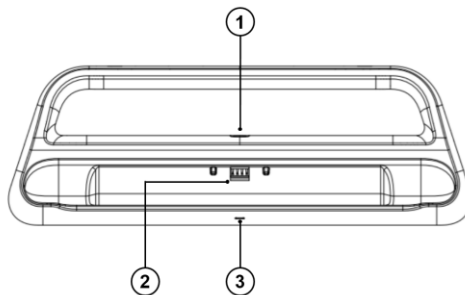


Figure 2-4 Docking Station

- 1. DC Power Port — connects to the AC/DC adapter for power supply
- 2. Charging Dock — holds the tablet for optimum viewing and convenient charging
- 3. Status Indicator Light

The indicator light displays differently in response to the tablet status described below:

- A. Green light — battery power of the tablet is sufficient ($\geq 90\%$)
- B. Yellow light — battery level is above 14% but below 90%
- C. Red light — battery level is below 14%

 **NOTE**

Ensure the docking station is clear of any small metal or other conductive parts to avoid short circuit damage to the charger and the tablet.

2.1.3 Power Sources

The tablet can receive power from any of the following sources:

- Internal Battery Pack
- AC/DC Power Supply
- Vehicle Power

 **IMPORTANT**

Do not charge the battery when the temperature is lower than 0 °C (32 °F) or higher than 45 °C (113 °F).

2.1.3.1 *Internal Battery Pack*

The tablet can be powered with the internal rechargeable battery, which if fully charged can provide sufficient power for about 8 hours of continuous operation.

2.1.3.2 *AC/DC Power Supply*

The tablet can be powered from an electrical outlet using the AC/DC power adapter. The AC/DC power supply also charges the internal battery pack.

2.1.3.3 *Vehicle Power*

The tablet can be powered from the auxiliary power outlet adapter or other DC power port on the test vehicle through a direct cable connection. The vehicle power cable connects to the DC power supply port on the top side of the tablet.

2.1.4 Technical Specifications

Table 2-2 Tablet Specifications

Item	Description
Operating System	Android 11
Processor	Octa-core processor (2.8 GHz)
Memory	8 GB RAM & 256 GB on-board memory
Display	12.7-inch TFT-LCD with 2732 x 2048 resolution & capacitive touchscreen
Connectivity	<ul style="list-style-type: none"> ● Wi-Fi x 2 (802.11 a/b/g/n/ac/ax 2x2 MIMO) ● BT V5.0 + EDR ● GPS ● USB 2.0 (Two USB host Type A, one USB mini device) ● HDMI 2.0 ● SD Card (support up to 256 GB)
Camera	<ul style="list-style-type: none"> ● Rear: 16 Megapixel, autofocus with flashlight ● Front: 16 Megapixel
Sensors	<ul style="list-style-type: none"> ● Gravity Accelerometer ● Ambient Light Sensor (ALS)
Audio Input / Output	<ul style="list-style-type: none"> ● Microphone ● Dual speakers ● 3-band 3.5 mm stereo/standard headset jack
Power and Battery	<ul style="list-style-type: none"> ● 18000 mAh 3.8 V lithium-polymer battery ● Charging via 12 V AC/DC power supply with the temperature between 0 °C (32 °F) and 45 °C (113 °F)
Input Voltage	12 V/3 A adapter
Operating Temp.	0 °C to 50 °C (32 °F to 122 °F)
Storage Temp.	-10 °C to 60 °C (14 °F to 140 °F)
Dimensions (W x H x D)	366.5 mm (14.43") x 280.9 mm (11.06") x 34 mm (1.34")

Item	Description
Weight	2.06 kg (4.53 lbs.)
Protocols	PLC J2497, ISO-15765, SAE-J1939, ISO-14229 UDS, SAE-J2411 Single Wire Can (GMLAN), ISO-11898-2, ISO-11898-3, SAE-J2819 (TP20), TP16, ISO-9141, ISO-14230, SAE-J2610 (Chrysler SCI), UART Echo Byte, SAE-J2809 (Honda Diag-H), SAE-J2740 (GM ALDL), SAE-J1567 (CCD BUS), Ford UBP, Nissan DDL UART with Clock, BMW DS2, BMW DS1, SAE J2819 (VAG KW81), KW82, SAE J1708, SAE-J1850 PWM (Ford SCP), SAE-J1850 VPW (GM Class2), ISO 13400, CAN FD

Table 2-3 Docking Station Specifications

Item	Description
Input Voltage	DC 12 V/3 A
Operating Temp.	0 °C to 45 °C (32 °F to 113 °F)
Storage Temp.	-20 °C to 60 °C (-4 °F to 140 °F)
Dimensions (W x H x D)	396 mm (15.59") x 136 mm (5.35") x 54 mm (2.13")
Weight	0.98 kg (2.16 lbs.)

2.2 MaxiFlash VCMII — Vehicle Communication and Measurement Interface

2.2.1 Function Description

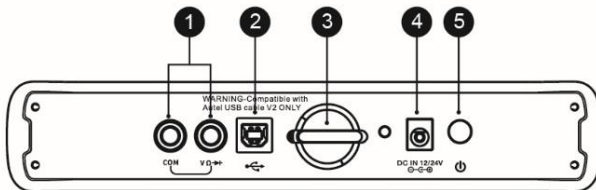


Figure 2-5 VCMII Top View

1. Multimeter Jacks
2. USB Port
3. Hook
4. DC Power Supply Input Port
5. Power Button

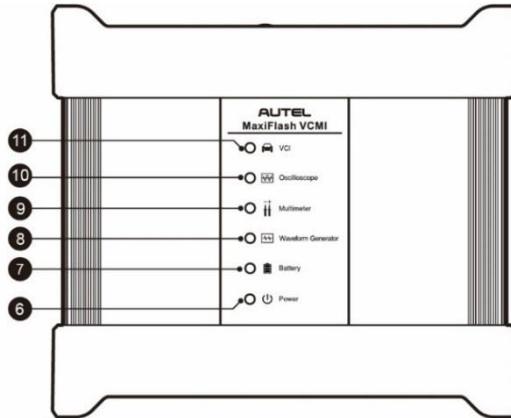


Figure 2-6 VCM1 Front View

6. Power LED — refer to [Table 2-4 Power LED Description](#) for details
7. Battery LED — refer to [Table 2-5 Battery LED Description](#) for details
8. Waveform Generator LED — lights green when operating in the waveform generator mode
9. Multimeter LED — lights green when operating in the multimeter mode
10. Oscilloscope LED — flashes green when operating in the oscilloscope mode
11. Vehicle LED — refer to [Table 2-6 Vehicle LED Description](#) for details

! IMPORTANT

Do not disconnect the programming device while this vehicle LED status light is on. If the flash programming procedure is interrupted while the vehicle's ECU is blank or only partially programmed, the module may be unrecoverable.

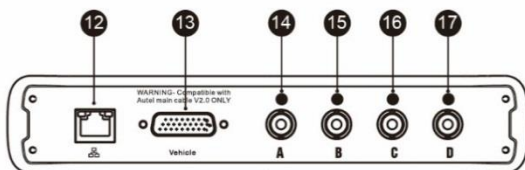


Figure 2-7 VCMI Bottom View

- 12. Ethernet Port
- 13. Vehicle Data Connector (DB26-Pin)
- 14. Input Channel A
- 15. Input Channel B
- 16. Input Channel C
- 17. Input Channel D

Table 2-4 Power LED Description

LED	Color	Description
Power	Yellow	Lights yellow automatically at power up when VCMI is self-testing.
	Green	Lights solid green when VCMI is powered on.
	Red	<ul style="list-style-type: none"> ● Lights solid red when a system failure occurs. ● Flashes red when VCMI is upgrading.

Table 2-5 Battery LED Description

LED	Color	Description
Battery	Green	<ul style="list-style-type: none"> ● Flashes green when VCMI is charging. ● Lights solid green when fully charged or the battery level is above 50%.
	Yellow	Lights yellow when the battery level is above 25% but below 50%.
	Red	<ul style="list-style-type: none"> ● Lights red when the battery level is above 10% but below 25%. ● Flashes red when the battery level is below 10%.

Table 2-6 Vehicle LED Description

LED	Color	Description
Vehicle	Green	<ul style="list-style-type: none">● Lights solid green when connected via USB cable.● Flashes green when communicating via USB/Ethernet cable.
	Blue	<ul style="list-style-type: none">● Lights solid blue when connected via Ethernet cable/Bluetooth.● Flashes blue when communicating via Bluetooth.
	Cyan	<ul style="list-style-type: none">● Lights solid cyan when connected via Wi-Fi.● Flashes cyan when communicating via Wi-Fi.

NOTE

Sometimes the vehicle LED lights yellow when the VCMI device is connected by other tablets, please wait for 2 minutes to automatically disconnect them, or when the Wi-Fi signal is weak, please try to reconnect the VCMI.

2.2.1.1 Communication Capability

The Vehicle Communication and Measurement Interface supports Bluetooth (BT), Wi-Fi and USB communications. It can transmit vehicle data to the tablet with or without a cable connection. In open areas, the working range of the transmitter through BT communication is up to 328 feet (100 m). The working range of 5G communication Wi-Fi is up to 164 feet (50 m). If the signal is lost due to being taken out of range, communication will be restored once the tablet is within range.

2.2.1.2 Measurement Capability

The VCMI device is designed with the functions of multimeter, oscilloscope, waveform generator, and bus inspection. The parameters such as voltage, resistance, current, signal frequency, and voltage-time characteristic of the signal, can be measured and the results are displayed on the tablet.

2.2.1.3 Programming Capability

The VCMI device is a D-PDU, SAE J2534 & RP1210 compliant PassThru programming interface device. Using the updated OEM software, it is capable of replacing the existing software/firmware in the Electronic Control Units (ECUs), programming new ECUs and fixing software-controlled drivability issues and emission issues.

2.2.2 Power Sources

The VCMI device can receive power from the following sources:

- Vehicle Power
- AC/DC Power Supply
- Built-in Rechargeable Battery Pack

2.2.2.1 Vehicle Power

The VCMI device operates on 12/24 V vehicle power, which receives power via the vehicle data connection port. The device powers on whenever it is connected to an OBD II/EODB compliant Data Link Connector (DLC). For non-OBDII/EODB compliant vehicles, the device can be powered from an auxiliary power outlet adapter or other suitable power port on the test vehicle using the auxiliary power cable.

2.2.2.2 AC/DC Power Supply

The VCMI device can be powered from a wall socket using the AC/DC power adapter.

2.2.2.3 Built-in Battery Pack

The VCMI device can also be powered with its built-in 3750 mAh battery pack.

2.2.3 Technical Specifications

Table 2-7 VCMI Specifications

Item	Description
Communications	<ul style="list-style-type: none">● BT V4.2 + EDR● USB 2.0● Wi-Fi 5G● Ethernet
Wireless Frequency	5 GHz
Power and Battery	<ul style="list-style-type: none">● 3750 mAh lithium-polymer battery● Charging via 12 V DC power supply
Operating Temp.	0 °C to 50 °C (32 °F to 122 °F)
Storage Temp.	-20 °C to 60 °C (-4 °F to 140 °F)
Dimensions (W x H x D)	192 mm (7.56") x 214 mm (8.43") x 39 mm (1.54")
Weight	1.2 kg (2.64 lbs.)

2.3 Accessories Kit

2.3.1 Main Cable

The VCMI device can be powered through the Autel main cable V2.0 (the V2.0 icon can be seen on the cable) when connected to an OBDII/EOBD compliant vehicle. The main cable connects the VCMI device to the vehicle's Data Link Connector (DLC), through which the VCMI device can transmit vehicle data to the tablet.

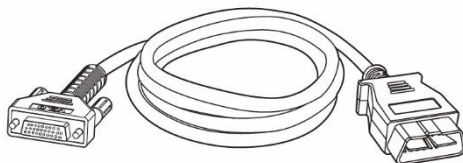










Figure 2-8 Main Cable V2.0




NOTE

The MaxiFlash VCMI can only be connected by the Autel main cable V2.0. DO NOT use other Autel main cables to connect the MaxiFlash VCMI.





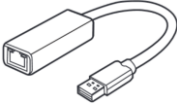
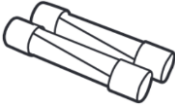
2.3.2 OBDI-Type Adapters (Optional)

The optional OBDI-type adapters are for non-OBDII vehicles. The adapter used depends on the type of vehicle being tested. The most common adapters are shown below. (Adapters are sold separately. Please contact your distributor for details.)

 Benz-14	 Chrysler-16	 BMW-20	 Nissan-14
 Kia-20	 Fiat-3	 PSA-2	 Mazda-17

 <p>Volkswagen/ Audi-2+2</p>	 <p>Benz-38</p>	 <p>Mitsubishi/ Hyundai-12+16</p>	
---	--	--	--

2.4 Other Accessories

	<p>USB 2.0 Cable V2 (the V2 icon can be seen on the cable)</p> <p>Connects the tablet to the VCMI device.</p>
	<p>AC/DC Adapter (12 V)</p> <p>Connects the tablet to the external AC/DC power port for power supply.</p>
	<p>Auxiliary Power Outlet Adapter</p> <p>Provides power to the tablet or the VCMI device through connection to the vehicle's auxiliary power outlet adapter receptacle, as some non-OBDII vehicles cannot provide power via the DLC connection.</p>
	<p>Clamp Cable</p> <p>Provides power to the tablet or the VCMI device through connection to the vehicle's battery.</p>
	<p>USB to Ethernet Adapter</p> <p>Network connection function can be realized through this device.</p>
	<p>Lighter Fuse x2</p> <p>A safety device for the auxiliary power outlet adapter.</p>

3 Getting Started

Make sure that the tablet has sufficient power or is connected to the external power supply (see [Power Sources](#)).

3.1 Power Up

Long press (press and hold) the **Power/Lock** button on the top-right side of the tablet to switch the unit on. Swipe up from the bottom of the Lock screen to enter the MaxiSys Job Menu screen.

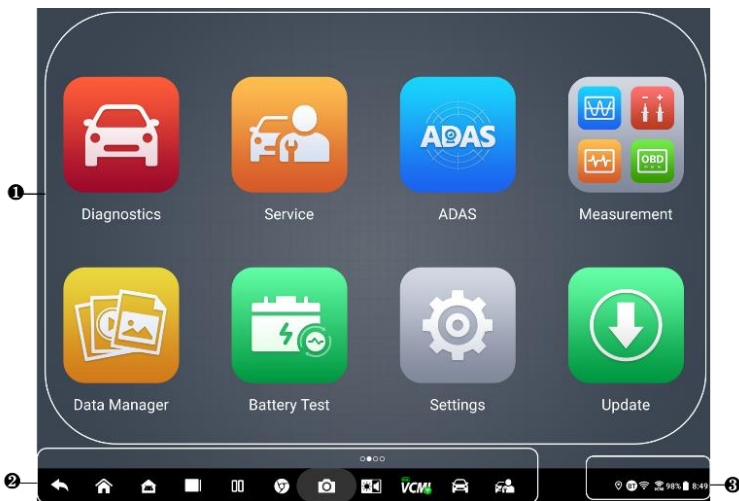


Figure 3-1 *MaxiSys Job Menu*

1. Application Buttons
2. Locator and Navigation Buttons
3. Status Icons

NOTE

It is recommended that you lock the screen when not in use to protect information in the system and conserve the power.










Almost all operations on the tablet are controlled through the touchscreen. The touchscreen navigation is menu-driven, allowing for quick access to the test procedure











or the data that you need, through a series of questions and options. Detailed descriptions of the menu structures are found in the chapters for each application.

3.1.1 Application Buttons

The table below briefly describes each of the applications in the MaxiSys system.

Table 3-1 Applications










Button	Name	Description
	Diagnostics	Accesses the diagnostics functions. See Diagnostics .
	Service	Accesses special functions menu. See Service .
	ADAS	Accesses ADAS systems menu. See ADAS .
	Measurement	Software tools that measure vehicle system parameters including voltage, resistance, current, and monitor signal activities. See Measurement .
	Data Manager	Accesses the saved repair shop, customer and vehicle data including detailed vehicle diagnostics and test records. See Data Manager .
	Battery Test	Accesses the Battery Test menu with two functions, including in-vehicle test and out-vehicle test. See Battery Test .
	Settings	Accesses the system settings menu and general tablet menu. See Settings .
	Update	Accesses system software update menu. See Update .
	VCMI Manager	Accesses VCMI connection menu. See VCMI Manager .




Button	Name	Description
	MaxiTools	Includes Log collection and Factory data reset two parts.
	Support	Synchronizes Autel's online service database with the MaxiSys tablet. See Support .
	OEM Authorization	Manages the permissions for unlocking the OE gateway.
	Demonstration	Provides step-by-step operation demonstration for diagnostics.
	MaxiViewer	Provides a quick search for supported functions and/or vehicles. See MaxiViewer .
	MaxiVideo	Configures the unit to operate as a video scope device by connecting to an imager head cable for close vehicle inspections. See MaxiVideo .
	Quick Link	Provides associated website bookmarks to allow quick access to product update, service, support, and other information. See Quick Link .
	Remote Desktop	Configures your tablet to receive remote support using the TeamViewer application. See Remote Desktop .
	User Feedback	You can submit feedback through this application when you encounter problems during the use of the tablet. See User Feedback .
	Autel User Center	Allows users to register Autel tool for downloading the latest released software. See Autel User Center .

3.1.2 Locator and Navigation Buttons

Operations of the Navigation buttons at the bottom of the screen are described in the table below:


Table 3-2 Locator and Navigation Buttons

Icon	Name	Description
	Locator	Indicates the location of the screen. Swipe the screen left or right to view the previous or next screen.
	Back	Returns to the previous screen.
	MaxiSys Home	Returns to MaxiSys Job Menu.
	Android Home	Returns to Android system home screen.
	Recent Apps	Displays a list of applications that are currently running. Tap an app icon to launch. Close a running application by swiping it to the top. Or close all running applications by tapping Clear All .
	Split Screen	Tap it to display a split screen.
	Browser	Launches the Chrome Internet browser.
	Camera	Tap the Camera icon to open camera viewfinder. Press and hold the icon to capture a screenshot of the display screen. The saved files are auto-stored in the Data Manager application for later review. See Data Manager .
	Display & Sound	Adjusts the brightness of the screen and the volume of the audio output.

Icon	Name	Description
	VCMI Shortcut	Opens the VCMI Manager application. A green icon at the bottom-right corner indicates the VCMI device is connected, while a red “X” icon will be displayed if the connection fails. The battery status icon on the upper-left corner displays the remaining VCMI power.
	MaxiSys Shortcut	Returns to the Diagnostics screen.
	Service Shortcut	Returns to the Service screen.

➤ **To use the camera**

1. Tap the **Camera** icon. The camera screen opens.
2. Focus the image to be captured in the viewfinder.
3. Tap the **camera** icon on the right side of the screen. The viewfinder now shows the captured picture and auto-saves the taken photo.
4. Tap the thumbnail image on the top-right corner of the screen to view the stored images.
5. Tap the **Back** or **Home** button to exit the camera application.

 **NOTE**

After swiping the camera screen from left to right, the camera mode and video mode can be switched by tapping the **Camera** icon or **Video** icon.

3.1.3 System Status Icons

Your MaxiSys tablet is a fully functional Android tablet with the standard Android operating system status icons. Refer to Android documentation for additional information.

3.2 Power Down

All vehicle communications should be terminated before shutting down the tablet. A warning message displays if a shutdown is attempted while the tablet is communicating with the vehicle. Forcing a shutdown while the tablet is communicating with the vehicle may lead to ECU errors on some vehicles. Please exit the Diagnostics application before shutting off the tablet.

➤ **To power down the MaxiSys tablet**

1. Long press (press and hold) the **Power/Lock** button.
2. Tap the **Power Off** option.
3. Tap **OK**.

3.2.1 Reboot System

In case of a system crash, long press the **Power/Lock** button and tap **Restart** to reboot the system.

4 Diagnostics

The Diagnostics application can access the electronic control module of multiple vehicle control systems, including but not limited to the engine, transmission, antilock brake system (ABS), and airbag system (SRS).

4.1 Establish Vehicle Communication and Selection

4.1.1 Establish Vehicle Communication

The Diagnostics operations require connecting the MaxiSys tablet to the test vehicle through the VCMI device using the main cable. (Use the applicable OBD I-type adapter if needed.) To establish a proper vehicle communication with the tablet, you need to perform the following steps:

1. Connect the VCMI device to the vehicle's DLC for both communication and power supply.
2. Connect the VCMI device to the tablet via Bluetooth pairing, Wi-Fi, or USB connection.
3. When the above steps are completed, check the VCMI Manager Shortcut at the bottom of the screen. If a green BT, Wi-Fi, or USB icon displays at the lower-right corner, the MaxiSys tablet is ready to start vehicle diagnosis.

4.1.1.1 *Vehicle Connection*

The method used to connect the VCMI device to a vehicle's DLC depends on the vehicle's configuration as follows:

- A vehicle equipped with an On-board Diagnostics Two (OBDII) management system supplies both communication and 12-volt power through a standardized J-1962 DLC.
- A vehicle not equipped with an OBDII management system supplies communication through a DLC connection, and in some cases supplies 12-volt power through the auxiliary power outlet adapter receptacle or a connection to the vehicle battery.

OBDII Vehicle Connection

This type of connection only requires the main cable without any additional adapter.

➤ **To connect to an OBDII vehicle**

1. Connect the main cable's female adapter to the Vehicle Data Connector on the VCMI device, and tighten the captive screws.
2. Connect the cable's 16-pin male adapter to the vehicle's DLC, which is generally located under the vehicle dashboard.

🔪 **NOTE**

The vehicle's DLC is not always located under the dashboard. Refer to the user manual of the test vehicle for additional connection information.

Non-OBDII Vehicle Connection

This type of connection requires both the main cable and a required OBDI adapter for the specific vehicle being serviced.

There are three possible conditions for non-OBDII vehicle connection:

- DLC connection supplies both communication and power.
- DLC connection supplies communication, and power is to be supplied via the auxiliary power outlet adapter connection.
- DLC connection supplies communication, and power is to be supplied via connection to the vehicle battery.

➤ **To connect to a non-OBDII vehicle**

1. Connect the main cable's female adapter to the Vehicle Data Connector on the VCMI device, and tighten the captive screws.
2. Locate the required OBDI adapter and connect its 16-pin jack to the main cable's male adapter.
3. Connect the attached OBDI adapter to the vehicle's DLC.

🔪 **NOTE**

Some vehicles may have more than one adapter or may have test leads instead of an adapter. Make the proper connection to the vehicle's DLC as required.

➤ **To connect the auxiliary power outlet adapter**

1. Plug the DC power connector of the auxiliary power outlet adapter into the DC power supply input port on the device.
2. Connect the male connector of the auxiliary power outlet adapter into the vehicle's auxiliary power outlet adapter receptacle.

➤ **To connect the clamp cable**

1. Connect the tubular plug of the clamp cable to the male connector of the auxiliary power outlet adapter.

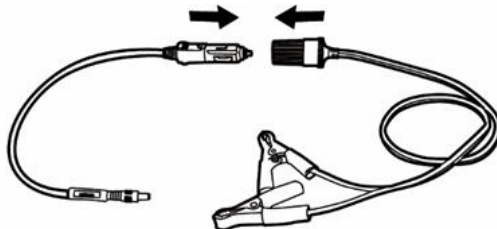


Figure 4-1 Connection Between Auxiliary Power Outlet Adapter and Clamp Cable

2. Plug the DC power connector of the auxiliary power outlet adapter into the DC power supply input port of the VCMI device.
3. Connect the clamp cable to the vehicle's battery.

4.1.1.2 VCMI Connection

After the VCMI device is properly connected to the vehicle, the Power LED on the VCMI device lights solid green and a beep sound will be heard, indicating it is ready to establish a communication with the tablet.

Coming with the MaxiSys tablet tool kit, the VCMI device supports three communication methods with the tablet: Bluetooth, Wi-Fi, and USB cable.

Pairing Up via Bluetooth


In open areas, the working range for Bluetooth communication is about 328 feet (100 m), giving technicians greater mobility to perform vehicle diagnosis from anywhere in the repair shop.

To expedite multi-vehicle diagnostics, more than one VCMI can be used in busy repair shops, enabling technicians to quickly pair their MaxiSys tablet to each VCMI via Bluetooth separately, therefore eliminating the need to unplug the VCMI from one vehicle and then connect it to another each time.

➤ **To pair the tablet with the VCMI device via Bluetooth**

1. Power up the tablet.
2. Select the **VCMI Manager** application from the MaxiSys Job Menu.
3. Select **VCMI BT** from the connection mode list and tap the Bluetooth toggle to turn it **ON**. The device automatically scans for available VCMI devices for

Bluetooth pairing. The found devices are listed in the setting section on the bottom-right of the screen.

 **NOTE**

If no VCMI device is found, this may indicate that the signal strength is too weak to be detected. Reposition the VCMI device and remove all possible objects that may cause signal interference. Tap the **Scan** button at the top-right corner of the screen to rescan for VCMI devices.

4. Typically, the VCMI device name displays as “Maxi” suffixed with a serial number. Select the VCMI device for pairing. (If more than one VCMI is used, ensure the correct VCMI is selected to pair.)
5. When the pairing is successful, the connection status displays as “Connected.”
6. The VCMI Manager Shortcut on the bottom of the screen displays a green circle BT icon when the tablet and the VCMI are connected.

Refer to [VCMI Bluetooth Pairing](#) for additional information.

Wi-Fi Connection

The VCMI device supports 5 GHz Wi-Fi connection. In open areas, the working range of 5G Wi-Fi communication is up to 164 feet (50 m).

➤ **To pair the tablet with the VCMI device via Wi-Fi**

1. Power up the tablet.
2. Select the **VCMI Manager** application from the MaxiSys Job Menu.
3. Select **Wi-Fi** from the connection mode list and tap the Wi-Fi toggle to turn it **ON**. The tablet automatically scans for available VCMI devices for Wi-Fi connection. Found VCMI devices are listed in the setting section on the bottom-right of the screen.
4. Typically, the VCMI device name displays as “Maxi” suffixed with a serial number. Select the required device for connection.
5. When the pairing is successful, the connection status is shown as “Connected.”
6. The VCMI Manager Shortcut on the bottom of the screen displays a green circle Wi-Fi icon when the tablet and the VCMI are connected.

Refer to [Wi-Fi Connection](#) for additional information.

USB Cable Connection

The USB cable connection is a simple and quick way to establish a communication between the tablet and the VCMI device. After properly connecting the USB cable from the tablet to the VCMI device, the VCMI Manager Shortcut on the bottom of the screen

displays a green check mark and the Connection LED on the VCMI device lights solid green, indicating the connection between the devices is successful. The MaxiSys diagnostics tablet is now ready to perform vehicle diagnosis.

 **NOTE**

Since the USB connection provides the most stable communication and is therefore the recommended communication method between the tablet and VCMI when operating ECU programming or coding. The USB communication method will take priority over other connected communication methods.

4.1.1.3 *No Communication Message*

- A. If the tablet is unable to connect to the VCMI, an “Error” message displays. An “Error” message indicates the tablet is not communicating with the VCMI device. Troubleshoot the error by performing the following steps:
- Ensure the VCMI device is powered on.
 - When using the wireless connection, ensure the network is configured correctly and the proper device has been connected.
 - If the tablet loses communication abruptly during the diagnosis, ensure no objects are causing signal interruption.
 - Ensure the VCMI device is properly positioned with the VCMI front side up.
 - Move the tablet closer to the VCMI device. If using the wired connection, ensure the cable is securely attached to the VCMI.
 - Ensure the VCMI communication mode is lit for the selected communication type: Bluetooth, Wi-Fi, or USB cable.
- B. If the VCMI device is unable to establish a communication link, a message will display troubleshooting instructions. Possible causes for the communication error include:
- The VCMI device is unable to establish a communication link with the vehicle.
 - A vehicle system has been selected for diagnosis that is not supported by the vehicle.
 - There is a loose connection.
 - There is a blown vehicle fuse.
 - The vehicle or the data cable has a wiring fault.
 - There is a circuit fault in the data cable or adapter.
 - The vehicle identification is incorrectly entered.

4.2 Getting Started

Prior to first use of the Diagnostics application, ensure the VCMI device is properly connected to and is communicating with the tablet. See [Establish Vehicle Communication](#) for further details.

4.2.1 Vehicle Menu Layout

When the VCMI device is properly connected to the vehicle via the main cable, and paired to the tablet, the platform is ready to start vehicle diagnosis. Tap the **Diagnostics** application button on the MaxiSys Job Menu. The Vehicle Menu displays on the screen.






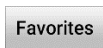






Figure 4-2 Vehicle Menu Screen

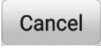
1. Top Toolbar Buttons
2. Manufacturer Icons

4.2.1.1 Top Toolbar Buttons

The operations of the toolbar buttons at the top of the screen are listed and described in the table below:

Table 4-1 Top Toolbar Buttons

Button	Name	Description
	Home	Returns to the MaxiSys Job Menu.
	VID	Tap this button to open a dropdown list: <ul style="list-style-type: none"> • Tap Auto Detect for auto VIN detection. • Tap Manual Input to enter VIN code or license number manually. • Tap Scan VIN/License to scan the VIN code/license number by camera.
	All	Displays all the vehicle makes in the vehicle menu.
	Favorites	Displays user-selected favorite vehicle makes.
	History	Displays the stored test vehicle history records. This option provides direct access to the previously tested vehicle recorded during previous test. See Vehicle History .
	America	Displays the American vehicle menu.
	Europe	Displays the European vehicle menu.
	Asia	Displays the Asian vehicle menu.
	China	Displays the Chinese vehicle menu.
	Search	Tap inside the search field to display a virtual keyboard and input the vehicle manufacturer to test.

Button	Name	Description
	Cancel	Tap this button to exit the search screen or to cancel an operation.

4.2.1.2 *Manufacturer Icons*

The manufacturer icons display the various vehicle brands. Select the manufacturer icon after the VCMI device is properly connected to the test vehicle to start a diagnostic session.

4.3 Vehicle Identification

The MaxiSys diagnostic system supports five methods of vehicle identification.

1. Auto Detect
2. Manual Input
3. Scan VIN/License
4. Manual Vehicle Selection
5. OBDII Direct Entry

4.3.1.1 *Auto Detect*

The MaxiSys diagnostic system features the latest VIN-based Auto Detect function to identify CAN vehicles with just one tap, enabling the technician to quickly identify the exact vehicle and scan its available systems for fault codes.

➤ **To perform Auto Detect**

1. Tap the **Diagnostics** application button from the MaxiSys Job Menu. The Vehicle Menu displays.
2. Tap the **VID** button on the top toolbar. Select **Auto Detect**. The tablet starts VIN scanning on the vehicle's ECU. Once the test vehicle is successfully identified, the system will guide you to the Diagnostics Main Menu screen.



Figure 4-3 VID Screen

4.3.1.2 Manual Input

For vehicles that do not support the Auto Detect function, the MaxiSys diagnostic system allows you to enter the vehicle VIN or license number manually, or simply take a photo of the VIN sticker or license plate for quick vehicle identification.

➤ **To perform Manual Input**

1. Tap the **Diagnostics** application button from the MaxiSys Job Menu. The Vehicle Menu displays.
2. Tap the **VID** button on the top toolbar.
3. Select **Manual Input**.
4. Tap the input box and enter the correct VIN code or license number.
5. Tap **OK**. The vehicle will be identified and matched to the vehicle database, and the system will guide you to the Diagnostics Main Menu screen.

4.3.1.3 Scan VIN/License

Tap **Scan VIN/License** in the dropdown list (see [Figure 4-3 VID Screen](#)), the camera will be opened. On the right side of the screen, from top to bottom, three options are available: **Scan Bar Code**, **Scan VIN**, and **Scan License**.

🚫 **NOTE**

The method of Scan License is supported in some countries and areas. Please manually input the license number if it is not available.

Select one of three options and position the tablet to align the VIN or license number within the scanning window, the result displays in the Recognition result dialog box after scanned. Tap **OK** to confirm the result, and then the vehicle information confirmation screen will display on the tablet. If all the vehicle information is correct, tap the icon in the middle of the screen to confirm the VIN of the vehicle being tested, tap **OK** to continue.

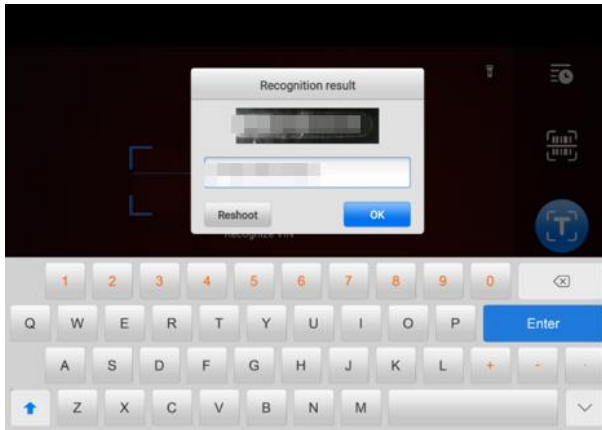


Figure 4-4 Scan VIN Code

If the VIN/License number cannot be scanned, please manually input the VIN/License number. Tap **OK** to continue. Confirm the VIN of the vehicle being tested to proceed.

4.3.1.4 Manual Vehicle Selection

When the vehicle's VIN is not automatically retrievable through the vehicle's ECU, or the specific VIN is unknown, you can select the vehicle manually.

Step-by-step Vehicle Selection

This mode of vehicle selection is menu-driven. Select a vehicle manufacturer on the Diagnostics Vehicle Menu screen and the Acquire VIN Information screen displays, then tap the **Manual Selection** button. Select the vehicle information like the Brand, Model, Capacity, Engine type, and Model year on the same screen. The **ESC** button at the lower-right corner of the screen will bring you back to the previous screen. Tap the **Reset** button to reselect the vehicle information if needed.

4.3.1.5 OBDII Direct Entry

Occasionally, the tablet may not be able to identify a vehicle. For these vehicles, the user may perform a generic OBDII or EOBD diagnostic. See [Generic OBDII Operations](#) for additional information.

4.4 Navigation

4.4.1 Diagnostics Screen Layout

After vehicle information is confirmed, tap **OK** to enter the main diagnostic program. This section describes common functions, including Auto Scan, Control Unit, Service, and Programming. The available functions may vary among different vehicles.

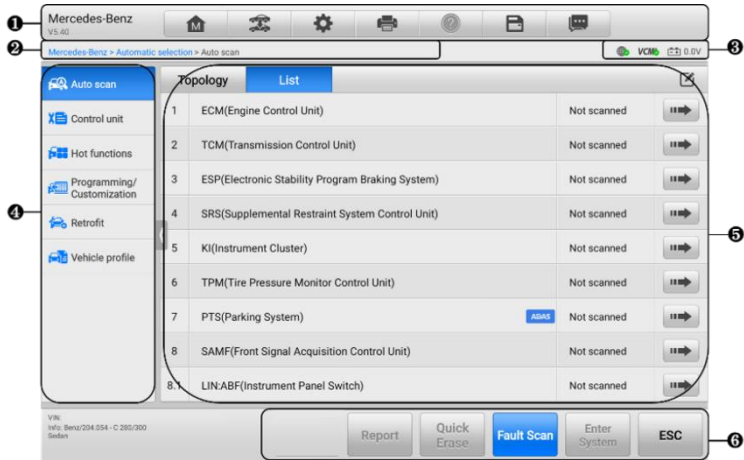









Figure 4-5 Diagnostics Main Menu Screen

1. Diagnostics Toolbar
2. Current Directory Path
3. Status Information Bar
4. Navigation Bar
5. Main Section
6. Function Buttons

4.4.1.1 Diagnostics Toolbar

The diagnostics toolbar contains buttons that allow you to print or save the displayed data and perform other operations. The table below provides a brief description for the operations of the diagnostics toolbar buttons:

Table 4-2 Diagnostics Toolbar Buttons

Button	Name	Description
	Home	Tap to return to MaxiSys Job Menu.
	Vehicle Swap	Exits the diagnostic session and returns to the vehicle menu screen to select another vehicle for testing.
	Settings	Opens the Settings screen. See Settings .
	Print	Saves and prints a copy of the displayed data. See Print Settings .
	Help	Provides instructions or tips for operations of various diagnostic functions.
	Save	Opens a submenu which provides options for data storage.
	Data Logging	Use this function when encountering an error while testing or diagnosing a vehicle. This function will record the communication data and ECU information of the test vehicle and send it to Autel's technical staff to review and provide solution. Go to the Support application to follow up the processing progress. See Data Manager .

➤ **To print data in Diagnostics**

1. Tap the **Diagnostics** application on the MaxiSys Job Menu. The **Print** button on the diagnostics toolbar is available throughout all Diagnostics operations.
2. Tap **Print** and a drop-down menu displays.
 - a) **Print This Page** — prints a screenshot copy of the current screen.
 - b) **Print All Data** — prints a PDF copy of all displayed data.
3. A temporary file will be created and sent via the computer to the printer.
4. When the file is sent, a confirmation message displays.

 **NOTE**

Make sure the tablet and the printer are connected either by Wi-Fi or LAN before printing. For more instructions on printing, see [Print Settings](#) for details.

➤ **To submit Data Logging reports in Diagnostics**

1. Tap the **Diagnostics** application on the MaxiSys Job Menu. The **Data Logging** button on the diagnostics toolbar is available throughout all Diagnostics operations.
2. Tap the **Data Logging** button to display the error options. Select a specific error, then tap **OK**, and a submission form will display to let you fill in the report information.
3. Tap the **Send** button in the upper-right corner of the screen to submit the report form via the Internet. A confirmation message displays when sent successfully.

4.4.1.2 *Current Directory Path*

The current directory path shows all directory names to access the current page.

4.4.1.3 *Status Information Bar*

The status information Bar at the top-right of the Main Section displays the following items:

1. **Network Status Icon** — indicates whether a network is connected.
2. **VCMI Icon** — indicates the communication status between the tablet and the VCMI device.
3. **Battery Icon** — indicates the battery status of the vehicle.

4.4.1.4 *Navigation Bar*

The navigation bar on the left side of the screen displays the main menu of the diagnostics functions. The main menu varies by the vehicle being tested. The common menu includes Auto Scan, Control Unit, Service, Hot Functions, Vehicle Profile, and Programming.

4.4.1.5 *Main Section*

The main section varies depending on the stage of operations which shows vehicle identification selections, the main menu, test data, messages, instructions, and other diagnostic information.

4.4.1.6 *Function Buttons*

The function buttons displayed at the bottom of the screen vary by operation. Function includes navigation, reporting, and code clearing. The functions of these buttons will be

described in the following sections when relevant.

 **NOTE**

The diagnostics toolbar (located on the top of the screen) will be active throughout the diagnostic session for tasks such as printing and saving the displayed data, obtaining help information, or performing data logging.

4.4.2 Screen Messages

Messages display when additional input is needed before proceeding. There are mainly three main types of on-screen messages: Confirmation, Warning, and Error.

4.4.2.1 Confirmation Messages

This type of messages usually displays as an “Information” screen, when you are about to perform an action that cannot be reversed or when an action has been initiated and your confirmation is needed to continue.

When a user-response is not required, the message displays briefly.

4.4.2.2 Warning Messages

This type of messages displays when completing the selected action may result in an irreversible change or loss of data. An example of this message is the “Erase Codes” message.

4.4.2.3 Error Messages

Error messages display when a systemic or procedural error has occurred. Possible errors include cable disconnection and communication interruption.

4.5 Diagnostics Menu

The Diagnostics application enables you to establish a data connection with the vehicle’s ECU through the VCMI device for vehicle diagnosis and maintenance.

The Main Menu screen (see [Figure 4-5 Diagnostics Main Menu Screen](#)) navigates users to perform read codes, clear codes, or perform comprehensive automotive diagnostic functions, and so on. After the function is selected, the tablet will establish a communication with the vehicle through the VCMI device, and enter the corresponding function menu or selection menu based on your selection.

4.6 Diagnostics Functions

Auto Scan

The Auto Scan function, which can be used to start auto scanning for all the available systems on the vehicle, will be listed on the navigation bar when accessing diagnostics function.

On the Auto Scan screen, there are two tabs: Topology Tab and List Tab.

A. Topology Tab Page

For a number of vehicle brands, including Volkswagen, Audi, BMW, Ford, Land Rover, Jaguar, Chrysler, Fiat, and Volvo, a topology map is available to display the relationship between vehicle systems. The Topology Tab page displays a system distribution diagram of the vehicle control modules.

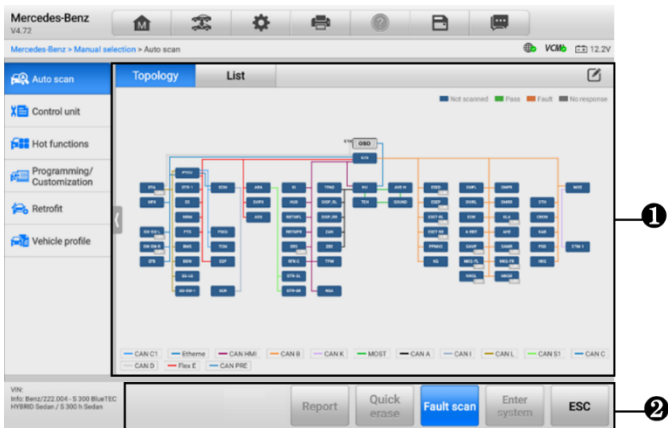


Figure 4-6 Topology Tab Page

B. List Tab Page

The List Tab page is available for most vehicles.

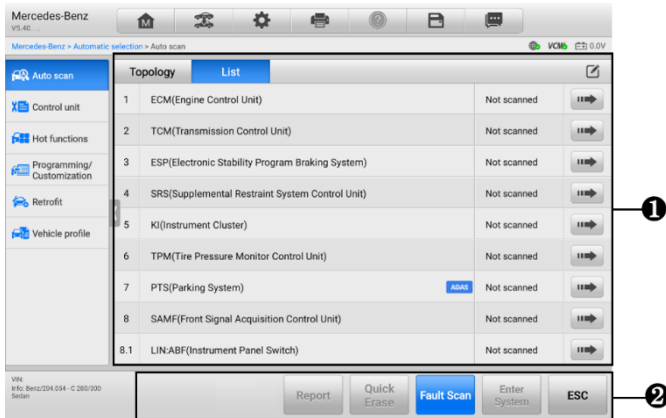


Figure 4-7 List Tab Page

1. Main Section

A. When displayed in a topology map

The ECU system of the tested vehicle is displayed in the form of a topology diagram, which describes the layout of the cables and systems of the vehicle control circuit and the path used for data transmission. Tap **Fault Scan** from the function buttons. The number of total faults will appear on the upper-right corner and the results will be displayed in different colors after scanning:

- Green: the system has detected no faults.
- Gray: the system has not received a response.
- Blue: the system has not been scanned.
- Orange: the system has detected faults. The number of faults appears on the upper-right corner of the system.

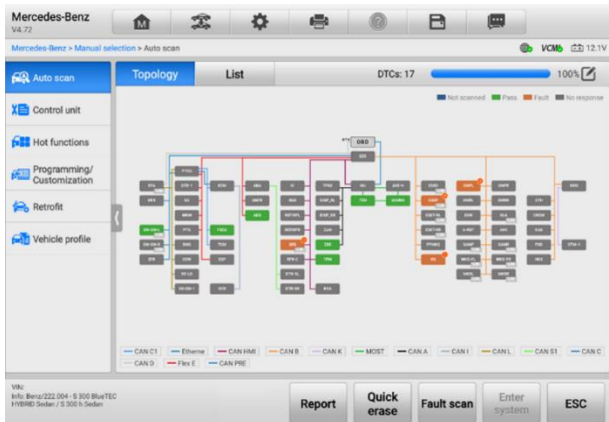



Figure 4-8 Scan Results in Topology Tab Page

B. When displayed in a list

- Column 1 — displays the system numbers
- Column 2 — displays the scanned systems
- Column 3 — displays the scan results
 - ✧ **Fault | #:** Indicates there is/are detected fault code(s) present; "#" indicates the quantity of detected faults.
 - ✧ **Pass | No Fault:** Indicates the system was scanned and no fault has been detected.
 - ✧ **Not Scanned:** Indicates the system has not been scanned.
 - ✧ **No Response:** Indicates the system has not received a response.
- Column 4 — tap the  button to enter a system for performing further diagnostics.

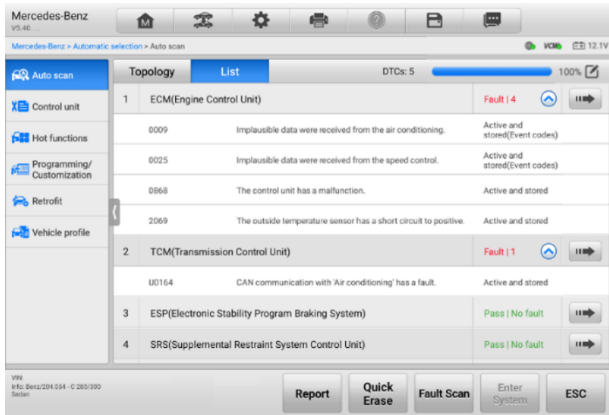


Figure 4-9 Scan Results in List Tab Page

2. Function Buttons

The table below provides a brief description of the function buttons:

Table 4-3 Function Buttons in Auto Scan Screen

Name	Description
Report	Displays the diagnostic data in report form.
Quick Erase	Erases all fault information after scanning.
Fault Scan	Scans vehicle system modules.
Pause	Pauses the scanning process.
Enter System	Enters the ECU system.
ESC	Returns to the previous screen or exits Diagnostics screen.

➤ To perform an Auto Scan function

Take topology as an example:

1. Tap the **Diagnostics** application button on the MaxiSys Job Menu. Choose the corresponding vehicle information and enter the Main Menu screen (see [Figure 4-5 Diagnostics Main Menu Screen](#)).
2. Select **Auto Scan** from the navigation bar.
3. The topology map displays in the main section. Tap the **Fault Scan** button at the bottom of the screen to scan the vehicle system modules.

Control Unit

The Control Unit function allows you to manually locate a required control system for testing through a series of choices. Simply follow the menu-driven procedures, and make proper selection each time; the program will guide you to the diagnostic function menu after a few choices you've made.

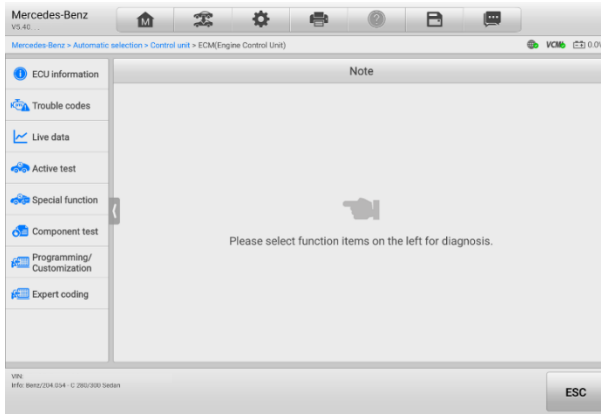


Figure 4-10 Control Unit Screen

Available functions may vary by vehicle. The function menu may include:

- **ECU Information** — displays detailed ECU information. Select to display information screen.
- **Trouble Codes** — contains Read Codes and Erase Codes. The former displays detailed DTC information retrieved from the vehicle control module. The latter facilitates you to erase DTCs and other data from the ECU.
- **Live Data** — retrieves and displays live data and parameters from the vehicle's ECU.
- **Active Test** — provides specific subsystem and component tests. This selection may display as *Actuators*, *Actuator Test*, or *Function Tests*. Available tests vary by vehicle.
- **Special Functions** — provides component adaptation or variant coding functions for custom configurations, and allows entry of adaptive values for certain components after repairs. Depending on the test vehicle, this selection may sometimes appear as Control Unit Adaptations, Variant Coding, Configuration, or something similar.

4.6.1 ECU Information

This function retrieves and displays the specific information for the tested control unit, including unit type, version numbers, and other information.

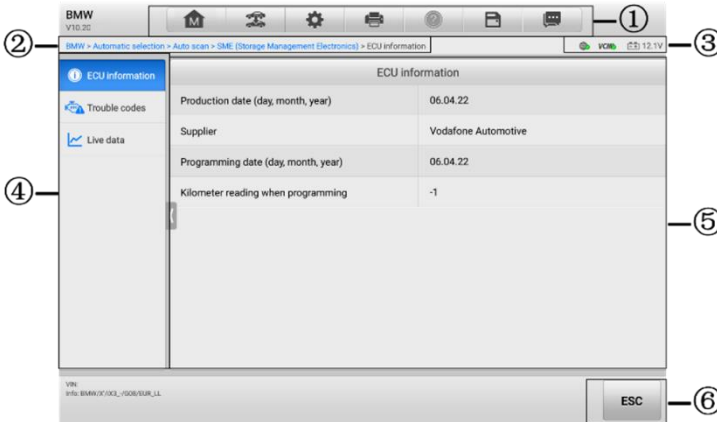


Figure 4-11 ECU Information Screen

1. Diagnostics Toolbar — see [Table 4-2 Diagnostics Toolbar Buttons](#) for detailed descriptions of the operations of each button.
2. Current Directory Path
3. Status Information Bar
4. Navigation Bar
5. Main Section — the left column displays the item names; the right column displays the specifications or descriptions.
6. Function Button — in this case, only an **ESC** button is available; tap it to exit after viewing.

4.6.2 Trouble Codes

The Freeze Frame, Read Codes, and Erase Codes function buttons are contained in the Trouble Codes screen. The Freeze Frame button will be activated if there are freeze frame data for viewing. Tap the **Erase Codes** button to erase DTCs and other data from the ECU, while tapping the **Read Codes** button to display the detailed DTC information retrieved from the vehicle control module. When tapping **Trouble Codes** from the navigation bar of the Control Unit screen, the tablet will automatically read the DTC information in ECU.

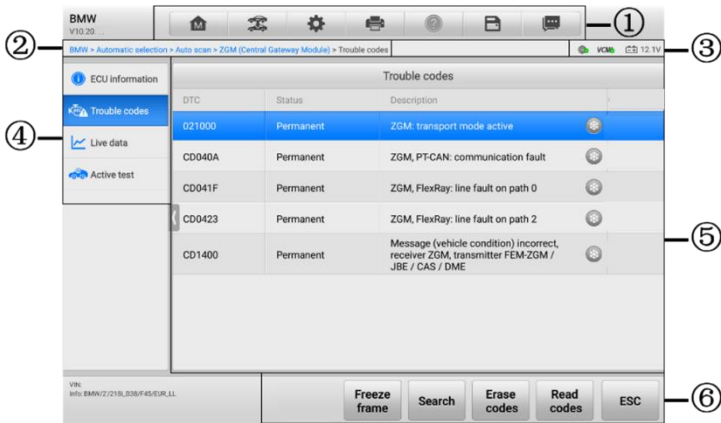


Figure 4-12 Trouble Codes Screen

1. Diagnostics Toolbar — see [Table 4-2 Diagnostics Toolbar Buttons](#) for detailed descriptions of the operations of each button.
2. Current Directory Path
3. Status Information Bar
4. Navigation Bar
5. Main Section
 - Column 1 — displays the retrieved codes from the vehicle
 - Column 2 — indicates the status of the retrieved codes
 - Column 3 — displays detailed descriptions for the retrieved codes
6. Function Buttons
 - **Freeze Frame** — a snowflake icon appears when freeze frame data is available for viewing. Tap the button to display data screen. The Freeze frame screen is similar to that of the Read codes screen and share similar operations.
 - **Search** — tap to search the selected DTC for additional information on the Internet.
 - **Erase Codes** — tap to erase codes from the ECU. It is recommended to read DTCs and make necessary repairs before erasing the codes.

After reading the retrieved codes from the vehicle and certain repairs have been made, you can erase the codes from the vehicle using this function. Before performing this function, make sure the vehicle's ignition key is in the ON (RUN) position with the engine off.

➤ To erase codes

1. Tap **Erase Codes** from the function buttons.
 2. A warning message displays to inform you of data loss when this function is applied.
 - ❖ Tap **Yes** to continue. A confirming screen displays when the operation is successfully done.
 - ❖ Tap **No** to exit.
 3. Tap **ESC** on the confirming screen to exit Erase Codes screen.
 4. Check the Read Codes function again to ensure the operation is successful.
- **Read Codes** — retrieves and displays the DTCs from the vehicle control system. The Read Codes screen varies for each vehicle being tested.
 - **ESC** — tap it to return to the previous screen or exit the function.

4.6.3 Live Data

When this function is selected, the screen displays the data list for the selected module. The parameters display in the order that they are transmitted by the ECU, so expect variation among vehicles.

Gesture scrolling allows you to quickly move through the data list. Touch the screen and drag your finger up or down to reposition the parameters being displayed if the data occupies more than one screen. The figure below displays a typical Live Data screen:

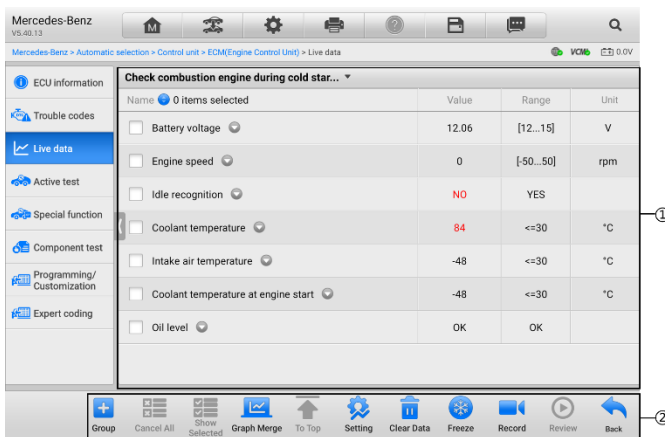


Figure 4-13 Live Data Screen

1. Main Section

- Name Column — displays the parameter names.
 - ✧ Check Box — tap the check box to the left of a parameter to select the item. Tap the check box again to deselect it.
 - ✧ Drop-down Button — tap the drop-down button on the right side of a parameter to open a submenu that provides optional modes in which to display the data.
- Value Column — displays the values of the parameters.
- Range Column — displays the ranges of the parameters.
- Unit Column — displays the unit for the parameter values. When you need to change the unit mode, tap the **Settings** button on the diagnostics toolbar and select a required mode. See [Unit](#).

a) Display Mode

There are four types of display modes available for data viewing, allowing you to view various types of parameters in the mode best suited to represent the data.

Tap the drop-down button on the right side of a parameter to open a submenu. A total of 8 buttons will be displayed: the 4 buttons on the left represent different data display modes, plus one **Information** button (active when additional information is available), one **Add to Custom Group** button (tap to add the selected parameters to the custom group), one **Unit Change** button (for switching the unit of displayed data), and one **Trigger** button (for opening the Trigger Settings window).

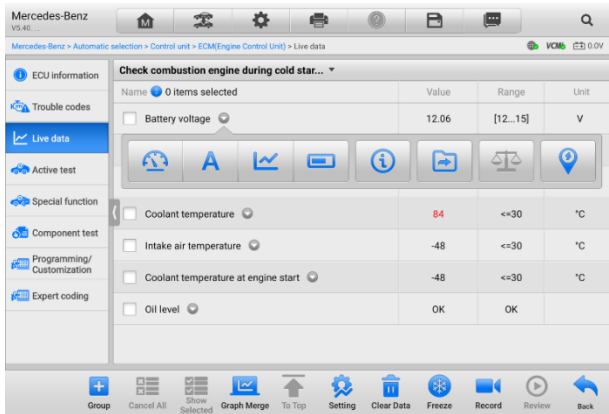


Figure 4-14 Display Mode Screen

Each parameter item displays the selected mode independently.

- ✧ **Analog Gauge Mode** — displays the parameters in gauge charts.
- ✧ **Text Mode** — the default mode that displays the parameters as a text list.

NOTE

Status parameters, such as a switch reading like ON, OFF, ACTIVE, and ABORT can only be displayed in Text Mode. Value parameters, such as a sensor reading, can be displayed in both text and graph modes.

- ✧ **Waveform Graph Mode** — displays the parameters in waveform graphs. In this mode, five control buttons will display on the right side of the parameter item, allowing you to manipulate the display status.

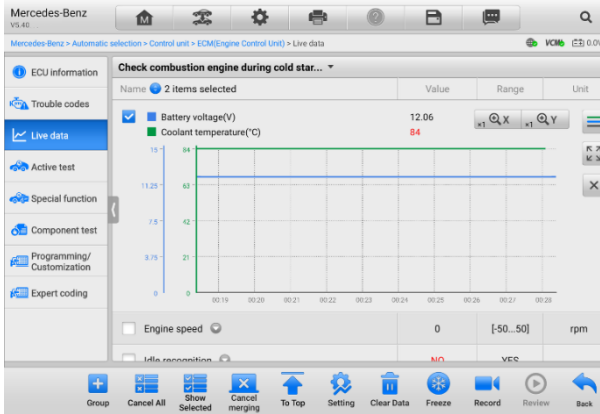


Figure 4-15 Waveform Graph Mode Screen

- 1) **Settings Button (SetY)** — sets the minimum and maximum value of the Y axis.
- 2) **Scale Button** — changes the scale values. There are four scales available for the X axis: x1, x2, x4 and x8. There are three scales available for the Y axis: x1, x2, and x4.
- 3) **Edit Button** — edits the waveform color and the line thickness.
- 4) **Zoom-in Button** — tap once to display the selected data graph in full screen.
- 5) **Exit Button** — tap to exit the waveform graph mode.

Full Screen Display — this option is only available in the waveform graph mode, and mostly used in Graph Merge status for data comparison. There are four control buttons available on the top-right side of the screen under this mode.

- **Scale Button** — tap to change the scale values below the waveform graph. There are four scales available for the X axis: x1, x2, x4 and x8. There are three scales available for the Y axis: x1, x2, and x4.

- **Edit Button** — tap to open an edit window, in which you can set the waveform color and the line thickness displayed for the selected parameter item.
 - **Zoom-out Button** — tap to exit full screen display.
 - **Exit Button** — tap to exit the waveform graph mode.
- **To edit the waveform color and line thickness**
1. Select parameter items to display in Waveform Graph mode.
 2. Tap the **Edit Button**, and an edit window displays.

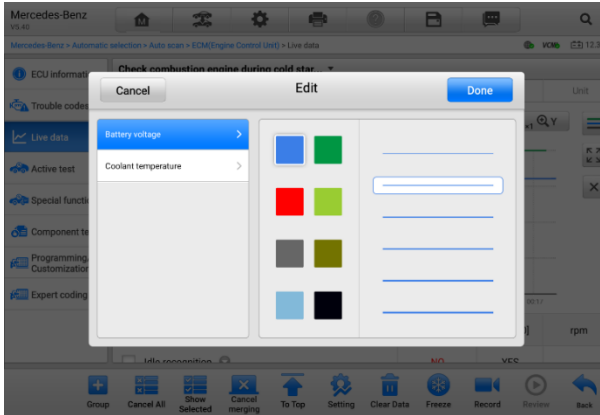


Figure 4-16 Waveform Edit Screen

3. The parameter item is selected automatically in the left column.
4. Select a color from the second column.
5. Select a line thickness from the right column.
6. Tap **Done** to save the setting and exit, or tap **Cancel** to exit without saving.

NOTE

In full screen display, please edit the waveform color and line thickness by tapping the **Edit** button on the top-right side of the screen.

◇ **Digital Gauge Mode** — displays the parameters in the form of a digital gauge graph.

b) **Trigger Settings**

On the trigger settings screen, you can set a standard range by filling in a minimum value and a maximum value. When exceeding this range, the trigger function will be executed and the device will automatically record and save the generated data. You can check the saved live data by tapping the **Review** button at the bottom of the screen.

Tap the drop-down button on the right side of the parameter name to open a submenu. The **Trigger** button is the last one in the submenu. Tap to display the trigger setting window.

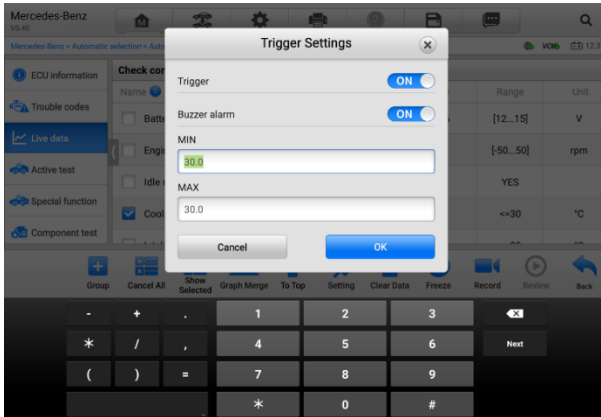


Figure 4-17 Trigger Settings Screen

Two buttons and two input boxes are available in the Trigger Settings window.

- Trigger On — switches the trigger on and off. The trigger is ON by default.
- Buzzer Alarm — switches the alarm on and off. The alarm function makes a beep sound as an alert when the data reading reaches the preset minimum or maximum point. The buzzer alarm will only sound at the first trigger.
- MIN — tap this input box to display a virtual keyboard to enter the required lower limit value.
- MAX — tap this input box to display a virtual keyboard to enter the required upper limit value.

➤ **To set a trigger**

- Tap the drop-down button on the right side of the parameter name to open a submenu.
- Tap the **Trigger** button on the right side of the submenu to open the trigger settings window.
- Tap the **MIN** input box and enter the required minimum value.
- Tap the **MAX** input box and enter the required maximum value.
- Tap **OK** to save the setting and return to the Live Data screen; or tap **Cancel** to exit without saving.

When the trigger is successfully set, a trigger mark displays in front of the parameter name. The mark is gray when it is not triggered, and displays orange when triggered. Moreover, two horizontal lines display on each of the data graphs (when Waveform Graph Mode is applied) to indicate the alarm point. The limit lines are shown in different colors to differentiate them from the parameter waveforms.

2. Function Buttons

The operations of the available functional buttons on the Live Data screen are described below:

- ✧ **Group** — tap to set the selected parameters to the same group.
- ✧ **Cancel All** — tap this button to cancel all selected parameter items. Up to 50 parameters can be selected at one time.
- ✧ **Show Selected/Show All** — tap this button to switch between the two options; one displays the selected parameter items, and the other displays all the available items.
- ✧ **Graph Merge** — tap this button to merge selected data graphs (for Waveform Graph Mode only). This function is very useful when comparing different parameters.

NOTE

This mode supports Graph Merge of 2 to 5 parameters that can be represented digitally. Non-digital parameters are not supported.

➤ **To merge selected data graphs**

1. Select parameter items to be merged.
 2. Tap the **Graph Merge** button at the bottom of the Live Data screen.
 - a) This mode only supports parameters that can be represented digitally. If non-digital parameters are selected, a message will display advising the user that the selected parameters are not supported in this mode and to select 2 to 5 digital parameters. Tap the **Got It** button to return to the previous screen and select supported parameters.
 - b) If parameters are selected that are not supported in this mode, a message will display advising the user to select only parameters that are supported. A message will also display if more than 5 parameters have been selected. Please select 2 to 5 of the supported parameters and tap the **OK** button to merge.
 3. Tap the **Cancel Merging** button at the bottom of the Live Data screen to cancel merge.
- ✧ **To Top** — moves a selected data item to the top of the list.
 - ✧ **Setting** — tap this button to set recording duration.

➤ **To set live data record duration**

1. Tap the **Setting** button at the bottom of the Live Data screen.
2. Tap the > button to the right of **Recording time after trigger** bar and select a time length.
3. Tap **OK** to save the setting and return to the Live Data Setting screen; or tap the "X" button at the upper-right corner to exit without saving.
4. Tap **Done** at the upper-right corner of the Live Data Setting screen to confirm and save the setting, and return to the Live Data screen; or tap **Cancel** to exit without saving.

◇ **Clear Data** — tap this button to clear all cached live data.

◇ **Freeze** — displays the retrieved data in freeze mode.

- Previous Frame — moves to the previous frame of frozen data.
- Next Frame — moves to the next frame of frozen data.
- Play/Pause — tap to play/pause the frozen data.
- Resume — tap to exit the freeze data mode and return to normal data display.

◇ **Record** — starts recording the live data of the selected data items. Tap the **Record** button at the bottom of the Live Data screen. A message will display prompting user to select parameters to record. Tap the **Got It** button to confirm. Scroll down and select data to record. Tap the **Record** button to start recording. Tap the **Resume** button to stop recording. The recorded live data can be viewed in the **Review** section at the bottom of the Live Data screen. The recorded data can also be reviewed in the Data Manager application.

● Resume — Tap this button to stop data recording and to return to normal data display.

● Flag — this button displays when the Record function is applied. Tap this button to set flags to note points of interest when recording data. Notes can be added during playback in Review or Data Manager. Select the preset flag to open a popup window and display a virtual keyboard to input notes.

◇ **Review** — review the recorded data. Tap the **Review** button to display a recording list, and select one item to review.

 **NOTE**

Only the data recorded during the current operation can be reviewed on the Live Data screen. All the historical recorded data can be reviewed in "Review Data" in the Data Manager application.

- Previous Frame — switches to the previous frame of recorded data.
- Next Frame — switches to the next frame of recorded data.
- Play/Pause — tap to play/pause the recorded data.

- Show Selected — display the selected parameter items.
- Graph Merge — merges selected data graphs.
- Back — exits the review, and returns to the Live Data screen.

✧ **Back** — returns to the previous screen or exits the function.

4.6.4 Active Test

The Active Test function is used to access vehicle-specific subsystem and component tests. Available tests vary by vehicle.

During an active test, the tablet sends commands to the ECU to activate the actuators. This test determines the integrity of the system or part by reading ECU data, or by monitoring the operation of the actuators. Such tests may include switching a solenoid, relay, or switch, between two operating states.

Selecting Active Test displays a menu of test options. Available tests vary by vehicle.

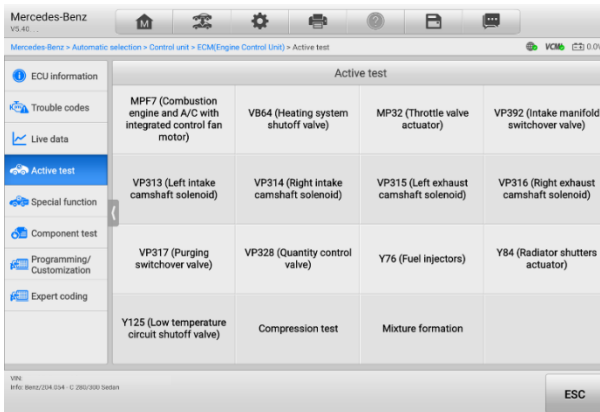


Figure 4-18 Active Test Screen

Select a test from menu options. Follow the instructions displayed on the screen to complete test. Procedures and instructions vary by vehicle.

The function buttons in the lower-right corner of the Active Test screen manipulate the test signals. The operational instructions are displayed in the main section of the test screen. Follow the on-screen instructions and make appropriate selections to complete the tests. Tap the **ESC** button to exit the test when finished.

4.6.5 Special Functions

Depending on the test vehicle, this selection may sometimes appear as Learning Process, Correction Programming, Emissions Inspection (Not valid for USA), OBD I/M Check (Not valid for USA), or something similar. You can select one to proceed according to your demands.

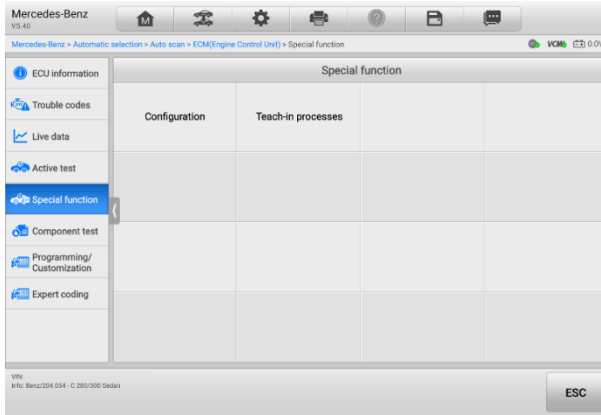


Figure 4-19 Special Functions Screen

4.7 Programming and Coding

Since the introduction of OBDII and leading up to modern hybrids and EVs, hardware and software technologies in cars have been advancing at an exponential rate. Updating software may be the only way to fix the following issues:

- Drivability
- Fuel Efficiency
- Power Loss
- Fault Codes
- Durability of Mechanical Parts

The Programming and Coding function is used to re-flash the vehicle control modules, which allows you to update the computer software of the vehicle to the latest version, as well as to reprogram adaptive data of certain components after making repairs or replacements.

 **NOTE**

The programming function applies only when the vehicle is connected with a VCMI device, which serves as a PassThru interface to establish communication with and transfer data to the vehicle's ECU.

Available programming or coding operations vary by test vehicle. Only the available operations display in the tablet menu.

There are two general types of programming operations:

- A. Coding — also known as Teach-in Program, or Component Adaptation, is used to reprogram adaptive data for vehicle control modules after repairs or replacements of vehicle parts.
 - B. Reprogramming — downloads the latest version of software from the online server database through Internet access (this procedure is done automatically when the tablet is connected to the Internet, so there is no need to check for software updates yourself), and reprograms the newest version into the vehicle's ECU.
-

 **NOTE**

Ensure that the tablet is connected to a stable internet access before applying the ECU programming function, so that the tablet is able to obtain access to the vehicle manufacturer's server for update service.

Selecting the Programming opens a menu of operation options that vary by vehicle make and model. Selecting a menu option either displays a programming screen or opens another menu of additional choices. Follow the on-screen instructions to operate. How and what information is presented on the screen vary by the type of operation being performed.

4.7.1 Coding

The main section of the Coding screen displays a list of vehicle components and the coding information that mainly consists of two parts:

1. All available systems for coding are displayed on the left side, and the coding data or value on the right side.
2. The bottom of the main section displays the functional buttons that enable you to manipulate the operation.

Check the vehicle condition and the coding information carefully. Use the functional button to edit Codes for the corresponding components. Tap **Send** when you finish editing all items. When the operation is completed, an execution status message such as Completed, Finished or Successful, may display.

Tap the **ESC** button to exit the function.

4.7.2 Reprogramming

Before reprogramming begins:

- It is mandatory that the tablet is connected to a stable Wi-Fi network.
- The tablet must be connected to the VCMII device via USB cable.
- The tablet battery must be fully charged during module programming. Connect the tablet to a charger if needed.
- Attach battery maintainer to vehicle battery to ensure a steady voltage is maintained throughout programming. Voltage requirements differ by vehicle manufacturer. Consult vehicle manufacturer recommendations prior to programming a module.
- Do not quit the application during a module reprogramming as the process may fail and may also result in permanent damage to the module.

Typical reprogramming operations require you to input and validate VIN number first. Tap the input box and enter the correct number. The programming interface then displays.

The main section of the reprogramming interface offers information of the hardware, the current software version and the newest software versions to be programmed into the control units.

A series of on-screen operational instructions will display to guide you through the programming procedure.

Carefully read the on-screen information and follow the instruction to execute the programming procedure.

4.7.3 Re-flash Errors

⚠ IMPORATANT

When reprogramming onboard, always make sure the vehicle battery is fully charged and in good working condition. During reprogramming, the operation may fail if voltage falls below the proper operation voltage. Sometimes a failed operation can be recovered, but the failed reprogramming can also ruin the control module. We recommend connecting an external battery maintainer to the vehicle to ensure a steady voltage is maintained throughout programming. The required voltage differs by vehicle manufacturer. Consult vehicle manufacturer for correct voltage to be maintained.

Occasionally a flash update procedure may not complete properly. Common causes of flash errors include poor cable connections between the tablet, VCMII, and vehicle, the vehicle ignition being switched off before the flash procedure is complete, or low vehicle

battery voltage.

If the process quits, recheck all the cable connections to assure good communications and initialize the flash procedure. The programming procedure will automatically repeat if the previous operation does not succeed.

4.8 Generic OBDII Operations

The OBDII/EOBD vehicle diagnosis option offers a quick way to check for DTCs, isolate the cause of an illuminated malfunction indicator lamp (MIL), check monitor status prior to emissions certification testing, and perform other emissions-related services. The OBDII direct access option is also used for testing OBDII/EOBD compliant vehicles that are not included in the database. Diagnostics Toolbar Buttons at the top of the screen are available for specific vehicle diagnostics. See [Table 4-2 Diagnostics Toolbar Buttons](#) for details.

4.8.1 General Procedure

➤ **To access the OBDII/EOBD diagnostics functions**

1. Tap the **Diagnostics** button from the MaxiSys Job Menu. The Vehicle Menu displays.
2. Tap the **EOBD** button. There are two options to establish communication with the vehicle.
 - Auto Scan — select it to establish communication using each protocol in order to determine which one the vehicle is using.
 - Protocol — select it to open a submenu of various protocols. A communication protocol is a standardized way of data communication between an ECM and a diagnostic tool. Global OBD may use several different communication protocols.
3. Select a specific protocol if the **Protocol** option is selected. Wait for the OBDII/EOBD Diagnostic Menu to appear.

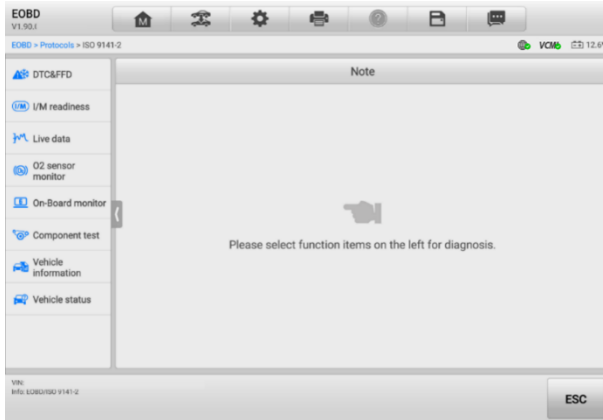


Figure 4-20 OBDII Diagnostic Menu

4. Select a function option to continue.
 - DTC & FFD
 - I/M Readiness
 - Live Data
 - O2 Sensor Monitor
 - On-Board Monitor
 - Component Test
 - Vehicle Information
 - Vehicle Status

NOTE

The supported functions may vary by vehicle.

4.8.2 Function Descriptions

This section describes the various functions of each diagnostic option:

4.8.2.1 DTC & FFD

When this function is selected, the screen displays a list of Stored Codes and Pending Codes. When the Freeze Frame data of certain DTCs are available for viewing, a snowflake button will display on the right side of the DTC item. The Erase Codes and Read codes functions can be applied by tapping the Function Buttons at the bottom of the screen.

- **Current Codes**

Current codes are emission-related DTCs from the ECM of the vehicle. OBD II/EOBD Codes have a priority according to their emission severity, with higher-priority codes overwriting lower-priority ones. The priority of the code determines the illumination of the Malfunction Indicator Lamp (MIL) and the codes erase procedure. Manufacturers rank codes differently, so DTCs may vary by vehicle.

- **Pending Codes**

These are codes whose storing conditions have been met during the last drive cycle, but need to be met on two or more consecutive drive cycles before the DTC stored. The purpose of displaying pending codes is to assist the service technician after a vehicle repair when diagnostic information is cleared, by reporting test results after a single driving cycle.

- a) If a test fails during the driving cycle, the DTC associated is reported. If the pending fault does not occur again within 40 to 80 warm-up cycles, the fault is automatically cleared from memory.
- b) Test results reported do not necessarily indicate a faulty component or system. If test results indicate another failure after additional driving, a DTC is stored to indicate a faulty component or system.

- **Freeze Frame**

In most cases the stored frame is the last DTC reported. Certain DTCs, those that have a greater impact on vehicle emission, have a higher priority. In these cases, DTC of the highest priority is the one for which the freeze frame records are retained. Freeze frame data includes a "snapshot" of critical parameter values at the time the DTC is stored.

- **Erase Codes**

This option is used to clear all emission-related diagnostic data including DTCs, freeze frame data and specific manufacturer-enhanced data from the vehicle ECM. This option resets the I/M Readiness Monitor Status for all vehicle monitors to Not Ready or Not Complete status.

A confirmation screen displays when the clear codes option is selected to prevent accidental loss of data. Select **Yes** on the confirmation screen to continue, or select **No** to exit.

4.8.2.2 *I/M Readiness*

This function is used to check the readiness of the monitoring system. It is an excellent function to use prior to having a vehicle inspected for state emissions compliance.

Selecting I/M Readiness opens a submenu with two choices:

- Since DTCs Cleared — displays the status of monitors since the last time the DTCs are erased.
- This Driving Cycle — displays the status of monitors since the beginning of the current drive cycle.

4.8.2.3 *Live Data*

This function enables the display of real-time PID data from the ECU. Displayed data includes analog and digital input and output, and system status information broadcast in the vehicle data stream.

Live data can be displayed in various modes, see [Live Data](#) for detailed information.

4.8.2.4 *O2 Sensor Monitor*

This function allows retrieval and review of recent O2 sensor monitor test results stored on the vehicle's on-board computer.

The O2 Sensor Monitor test function is not supported by vehicles that communicate using a controller area network (CAN). For O2 Sensor Monitor tests results of CAN-equipped vehicles, refer to [On-Board Monitor](#).

4.8.2.5 *On-Board Monitor*

This function allows you to view the results of On-Board Monitor tests. The tests are useful after the service when a vehicle's control module memory is already erased.

4.8.2.6 *Component Test*

This function enables dual-directional control of the ECM so that the diagnostic tool can transmit control commands to operate the vehicle systems. This function is useful in determining how well the ECM responds to a command.

4.8.2.7 *Vehicle Information*

This function enables the display of the vehicle identification number (VIN), calibration identification number, calibration verification number (CVN), and other information of the test vehicle.

4.8.2.8 *Vehicle Status*

This function checks the current condition of the vehicle, such as the communication protocols of OBDII modules, number of fault codes, and status of the Malfunction Indicator Light (MIL).

4.9 Diagnostic Report

4.9.1 Pre-Scan and Post-Scan Functions


After performing pre-scan and post-scan functions by entering the same maintenance order number, tap **Data Manager > Vehicle History** to select the historical test record named with the maintenance order number. Both the pre-scan results and post-scan results will be displayed in the same historical test record, which can be generated as a PDF report for easily comparing the changes between pre-scan and post-scan.

- **Pre-Scan Function**

Select and tap a vehicle button from the Vehicle Menu screen. Enter the maintenance order number in the pop-up box to scan and detect the whole vehicle. You can also add pictures to record the current condition of the vehicle. Once the pre-scan is completed, you are not allowed to perform pre-scan again, and the scan result cannot be modified.

- **Post-Scan Function**

After the pre-scan is complete, exit the current test vehicle and tap the vehicle button from the Vehicle Menu screen to reconnect again. Enter the same maintenance order number in the pop-up box. The screen for post-scan will display. The post-scan record will be generated when the scan is completed. The pre-scan results and post-scan results will be displayed in the same historical test record.

 **NOTE**

The post-scan function can be performed repeatedly. After exiting the vehicle, you only need to tap the vehicle button from the Vehicle Menu screen to reconnect again, then enter the same maintenance order number in the pop-up box and follow the steps to rescan. The last one is the final post-scan result.

4.9.2 Diagnostics Report Saving, Viewing, and Sharing

The diagnostic report can be reviewed, saved, and shared with others through many ways.

4.9.2.1 Diagnostics Report Saving

- Via the **History** function
 - 1) Tap **Diagnostics** on the MaxiSys Job Menu, and select **History** on the top toolbar.

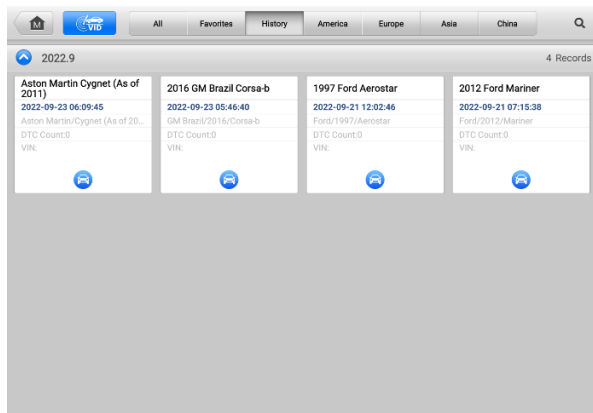


Figure 4-21 History Screen

- 2) Select a history record, and tap the **...** button on the upper-right corner.

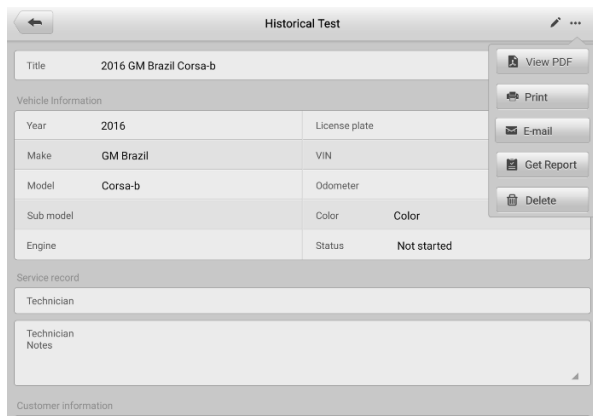


Figure 4-22 Historical Test Screen

- 3) Tap **Get Report**. Enter the license plate and current mileage. Tap **Save**.
- Via the **Auto Scan** function
 - 1) Enter the Auto Scan page and tap **Fault Scan** from the function buttons at the bottom of the screen.

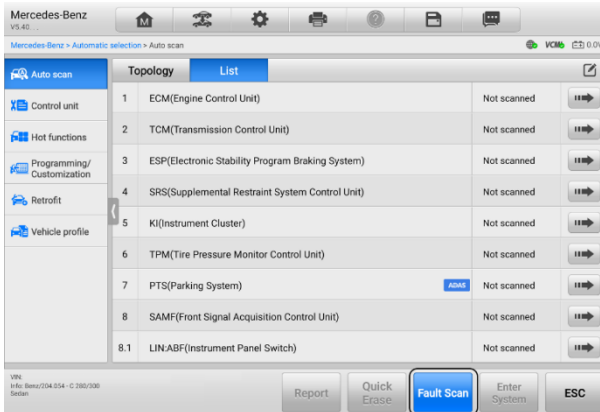


Figure 4-23 Auto Scan Screen 1

- 2) When the system scan is completed, tap **Report** from the function buttons at the bottom of the screen.

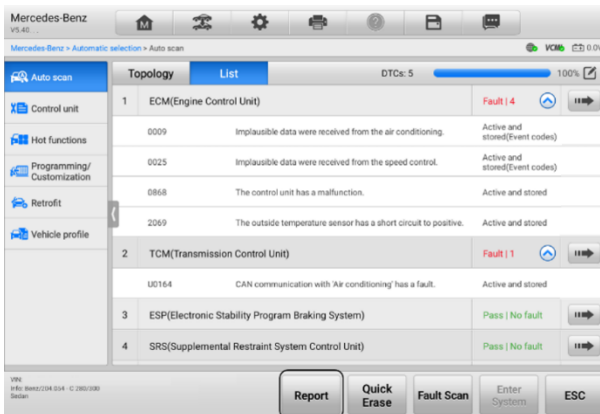





Figure 4-24 Auto Scan Screen 2

- Via the functions on the diagnostics toolbar

The diagnostic report can also be viewed from diagnostics functions screen including Auto scan and Trouble codes. There are two ways to view the saved reports:

- ✧ Tap the  button in the diagnostics toolbar and select **Save as PDF**. Enter the license number and tap **Save**. Tap the  button on the upper-right of the screen to view the report.
- ✧ Tap the  button in the diagnostics toolbar and select **Report to Cloud**. Enter the license number and current mileage. Tap **Save > View Report** and then select a saved report to view.

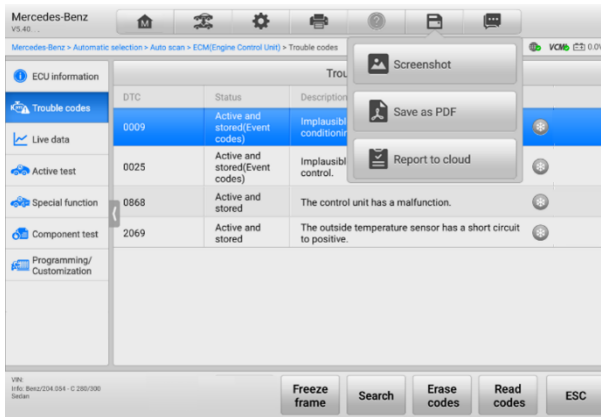


Figure 4-25 Trouble Codes Screen

4.9.2.2 Diagnostics Report Viewing

All the saved reports can be viewed in the Data Manger application.

- ✧ Tap **Data Manager > Vehicle History**. Select a specific vehicle history record and then tap **View PDF** in the upper-right corner to view the report.
- ✧ Once you save the reports by tapping the **Save as PDF** button, tap **Data Manager > PDF** to view these reports.
- ✧ Once you save the reports by tapping the **Get Report** or **Report to Cloud** button, tap **Data Manager > Cloud Report** to view these reports.

4.9.2.3 Diagnostics Report Cloud Sharing

- 1) Tap **Data Manager > Cloud Report** to enter the Report List screen.

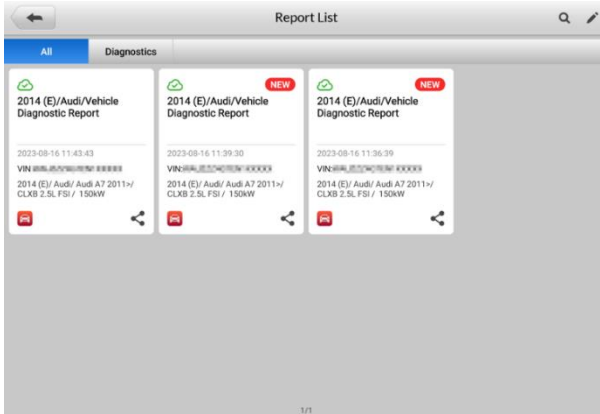





Figure 4-26 Report List

NOTE

Note that if the report displays  , it means the report has been uploaded to the cloud successfully, and you can share the report with others; if the report displays  , it means the report has failed to upload to the cloud, but will try to automatically upload to the cloud when entering the Report again.

- 2) Tap the  on the lower-right corner of the report.
- 3) There are three ways for report cloud sharing: scan the QR code, send by email, send by SMS (via phone number).

4.10 Exit Diagnostics

The Diagnostics application operates while communication with the vehicle is still active. It is important to properly exit from the diagnostics operation screen to stop all communications with the vehicle before closing the Diagnostics application.

NOTE

Damage to the vehicle electronic control module (ECM) may occur if communication is disrupted. Ensure all forms of communication link such as data cable, USB cable, and wireless or wired network, are properly connected throughout the test. Exit all screens before disconnecting the test cable and power supply.

➤ **To exit the Diagnostics application**

1. On an active diagnostics screen:
 1. Tap the **Back** or **ESC** button to exit a diagnostic session step by step.
 2. Or tap the **Vehicle Swap** button in the Diagnostics Toolbar to return to the Vehicle Menu screen.
2. On the vehicle menu screen:
 - 1) Tap the **Home** button on the Top Toolbar.
 - 2) Or tap the **Back** button on the Navigation Bar at the bottom of the screen.
 - 3) Or tap the **Home** button on the Diagnostics Toolbar to exit the application directly and return to the MaxiSys Job Menu.

 **NOTE**

After exiting the Diagnostics application, the tablet is no longer communicating with the vehicle and it is safe to open other MaxiSys applications.

5 Service

The Service section is specially designed to provide quick access to the vehicle systems for various scheduled service and maintenance tasks. The typical service operation screen is a series of menu driven executive commands. Follow on-screen instructions to select appropriate execution options, enter correct values or data, and perform necessary actions. The application will display detailed instructions to complete selected service operations.

After entering each special function, the screen will display two application choices: Diagnosis and Hot Functions. The Diagnosis enables the reading and clearing of codes which is sometimes necessary after completing certain special functions. Hot Functions consists of sub functions of the selected special function.

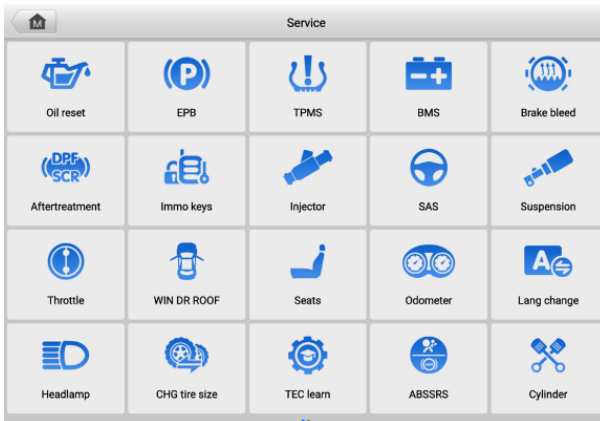


Figure 5-1 Service Menu

Several most commonly used services are described in this chapter.

5.1 Oil Reset Service

Perform reset for the Engine Oil Life system, which calculates an optimal oil life change interval depending on the vehicle driving conditions and climate. The Oil Life Reminder must be reset each time the oil is changed, so the system can calculate when the next oil change is required.

 **NOTE**

1. Always reset the engine oil life to 100% after every oil change.
 2. All required work must be carried out before the service indicators are reset. Failure to do so may result in incorrect service values and cause DTCs to be stored by the relevant control module.
 3. For some vehicles, the scan tool can reset additional service lights such as maintenance cycle and service interval. On BMW vehicles for example, service resets include engine oil, spark plugs, front/rear brakes, coolant, particle filter, brake fluid, micro filter, vehicle inspection, exhaust emission inspection and vehicle checks.
-


5.2 Electric Parking Brake (EPB) Service

This function has a multitude of usages to maintain the electronic braking system safely and effectively. The applications include deactivating and activating the brake control system, assisting with brake fluid control, opening and closing brake pads, and setting brakes after disc or pad replacement.

5.2.1 EPB Safety

It can be dangerous to perform Electric Parking Brake (EPB) system maintenance, so before you begin the service work, please keep these rules in mind.

- ✓ Ensure that you are fully familiar with the braking system and its operation before commencing any work.
- ✓ The EPB control system may be required to be deactivated before carrying out any maintenance/diagnostic work on the brake system. This can be done from the tool menu.
- ✓ Only perform maintenance work when the vehicle is stationary and on level ground.
- ✓ Ensure that the EPB control system is reactivated after the maintenance work has been completed.

 **NOTE**

Autel accepts no responsibility for any accident or injury arising from the maintenance of the Electric Parking Brake system.

5.3 Tire Pressure Monitoring System (TPMS) Service

This function allows you to quickly look up the tire sensor IDs from the vehicle ECU, as well as to perform TPMS replacement and reset procedures after tire sensors are replaced.

5.4 Battery Management System (BMS) Service

The Battery Management System (BMS) allows the tool to evaluate the battery charge state, monitor the close-circuit current, register the battery replacement, activate the rest state of the vehicle, and charge the battery via the diagnostic socket.

NOTE

1. This function is not supported by all vehicles.
 2. The sub functions and actual test screens of the BMS may vary by vehicle, please follow the on-screen instructions to make correct option selection.
-

The vehicle may use either a sealed lead-acid battery or an Absorbed Glass Mat (AGM) battery. Lead acid battery contains liquid sulphuric acid and can spill when overturned. AGM battery (known as VRLA battery, valve regulated lead acid) also contains sulphuric acid, but the acid is contained in glass mats between terminal plates.

It is recommended that the replacement aftermarket battery has the same specifications, such as capacity and type, as the exiting battery. If the original battery is replaced with a different type of battery (e.g. a lead-acid battery is replaced with an AGM battery) or a battery with a different capacity (mAh), the vehicle may require reprogramming of the new battery type, in addition to, performing the battery reset. Consult the vehicle manual for additional vehicle-specific information.

5.5 Diesel Particle Filter (DPF) Service

The Diesel Particle Filter (DPF) function manages DPF regeneration, DPF component replacement teach-in and DPF teach-in after replacing the engine control unit.

The ECM monitors driving style and selects a suitable time to employ regeneration. Cars driven a lot at idling speed and low load will attempt to regenerate earlier than cars driven more with higher load and speed. For regeneration to take place, a prolonged high exhaust temperature must be obtained.

In the event of the car being driven in such a way that regeneration is not possible, i.e., frequent short journeys, a diagnostic trouble code will eventually be registered in addition to the DPF light and "Check Engine" indicators displaying. A service regeneration can be requested in the workshop using the diagnostic tool.

Before performing a forced DPF regeneration using the tool, check the following items:

- The fuel light is not on.
- No DPF-relevant faults are stored in system.
- The vehicle has the specified engine oil.
- The oil for diesel is not contaminated.

! IMPORTANT

Before diagnosing the problematic vehicle and attempting to perform an emergency regeneration, it is important to obtain a full diagnostic log and read out relevant measured value blocks.

🔧 NOTE

1. The DPF will not regenerate if the engine management light is on, or there is a faulty EGR valve.
 2. The ECU must be re-adapted when replacing the DPF and when topping up the fuel additive Eolys.
 3. If the vehicle needs to be driven in order to perform a DPF service, a second person is needed for the function. One person should drive the vehicle while the other person observes the screen on the Tool. Do not attempt to drive and observe the scan tool at the same time. This is dangerous and puts your life and the lives of other motors and pedestrians at risk.
-

5.6 Immobilizer (IMMO) Service

An immobilizer is an anti-theft mechanism that prevents an automobile's engine from starting unless the correct ignition key or other device is present. This device prevents thieves from starting the car by a method known as hot wiring. Most new vehicles have an immobilizer as standard equipment. An important advantage of this system is that it doesn't require the car owner to activate it; it operates automatically. An immobilizer is considered as providing much more effective anti-theft protection than an audible alarm alone; many auto insurance companies offer lower rates for vehicles that are equipped with an immobilizer.

As an anti-theft device, an immobilizer disables one of the systems needed to start a car's engine, usually the fuel supply or the ignition. This is accomplished by radio frequency identification between a transponder in the ignition key and a device called a radio frequency reader in the steering column. When the key is placed in the ignition, the transponder sends a signal with a unique identification code to the reader, which relays it to a receiver in the vehicle computer control module. If the code is correct, the computer allows the fuel supply and ignition systems to operate and start the car. If the code is incorrect or absent, the computer disables the system, and the car will be unable to start

until the correct key is placed in the ignition.

The IMMO service can disable a lost vehicle key and program the replacement key fob. One or more replacement key fobs can be programmed.

5.7 Steering Angle Sensor (SAS) Service

SAS Calibration permanently stores the current steering wheel position as the straight-ahead position in the SAS EEPROM. Therefore, the front wheels and the steering wheel must be set exactly to the straight-ahead position before calibration. In addition, the VIN is also read from the instrument cluster and stored permanently in the SAS EEPROM. On successful completion of calibration, the SAS fault memory is automatically cleared.

Calibration must always be carried out after the following operations:

- Steering wheel replacement
- SAS replacement
- Any maintenance that involves opening the connector hub from the SAS to the column
- Any maintenance or repair work on the steering linkage, steering gear or other related mechanism
- Wheel alignment or wheel track adjustment
- Accident repairs where damage to the SAS or assembly, or any part of the steering system may have occurred.

NOTE

1. Autel accepts no responsibility for any accident or injury arising from servicing the SAS system. When interpreting DTCs retrieved from the vehicle, always follow the manufacturer's recommendation for repair.
 2. All software screens shown in this manual are examples, and actual test screens may vary by test vehicle. Pay attention to the menu titles and onscreen instructions to make correct option selections.
 3. Before starting procedure, make sure the vehicle has an ESC button. Look for button on dash.
-

6 ADAS

Advanced Driver Assistance Systems (ADAS) is an array of vehicle systems that aid the driver either through passive alerts or by active control of the vehicle to drive safer and with greater awareness and precision.

Cameras, sensors, ultrasound, radar and LIDAR are some of the systems used to capture the driving environment data, including travelling or static vehicles position, pedestrian location, road sign, driving lane and intersection detection, road (curves) and driving conditions (poor visibility or evening driving), use that information to instruct the vehicle to take its predetermined action. Cameras, sensors and sensing systems are typically located in front and rear bumpers, windshield, front grill and side and rearview mirrors.

Autel ADAS Calibration Tool provides comprehensive and precise ADAS calibration.

1. Covers many vehicle manufacturers, including Benz, BMW, Audi, Volkswagen, Porsche, Infiniti, Lexus, GM, Ford, Volvo, Toyota, Nissan, Honda, Hyundai, and Kia.
2. Supports the calibration of multiple driver assistant systems, including Adaptive Cruise Control (ACC), Night Vision System (NVS), Lane Departure Warning (LDW), Blind Spot Detection (BSD), Around View Monitoring (AVM), Rear Collision Warning (RCW), and Heads-up Displays (HUD).
3. Supplies graphic illustrations and step-by-step instructions.
4. Provides demos to guide the technician through the calibration.

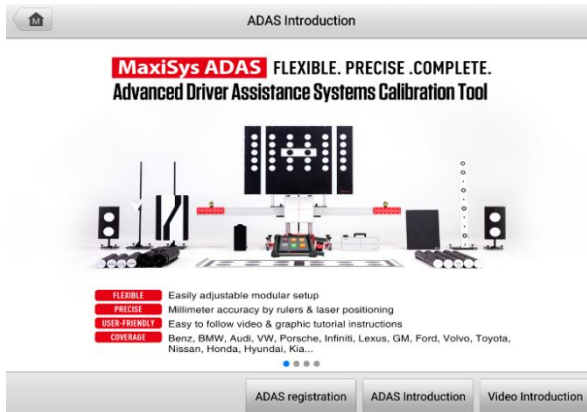


Figure 6-1 ADAS Introduction Screen

7 Measurement

The Measurement application can provide all the features needed for performing electrical and electronic circuit tests as well as monitoring signal activities on today's vehicles.

After properly connecting with a test vehicle and communicating with MaxiSys tablet, the VCMI (Vehicle Communication and Measurement Interface) is used as an integrated device that functions as an oscilloscope, a waveform generator, a multimeter, and a CAN bus inspection.

7.1 Oscilloscope

An oscilloscope is a measuring instrument that shows how a signal varies with time in a graphical way. Various signal activities can be displayed and monitored on a two-dimensional grid. The graphical form created by a signal is called a waveform. The voltage-time characteristic of the signal or waveform is drawn as a visual line called the trace.

7.1.1 Safety Information

Follow these instructions below to reduce the risk of injury from electric shock and prevent equipment damage.

A. Maximum input ranges

Observe all terminal ratings and warnings marked on the product.

DANGER

- To prevent electric shock, take all necessary safety precautions when working on equipment where voltages beyond the specified input range may exist. Contact with voltages outside of the specified measuring range presents a risk of electric shock.
 - To prevent injury or death, the oscilloscope must not be directly connected to the battery. To measure battery voltages, use a differential isolating probe specifically rated for battery use.
-

WARNING

Operation outside of the safe input range is likely to cause permanent damage to the oscilloscope and other connected equipment.

B. Grounding

DANGER

- The scope's ground connection through the USB cable is for measurement purposes only. The oscilloscope does not have a protective safety ground.
 - Do not connect the ground input (chassis) to any electrical power source. To prevent personal injury or death, use a voltmeter to check that there is no significant AC or DC voltage between the oscilloscope ground and the point to which you intend to connect the ground input.
-

WARNING

- Applying a voltage to the ground input is likely to cause permanent damage to the oscilloscope, the attached computer, and other equipment.
 - To prevent measurement errors caused by poor grounding, always use the high-quality USB cable supplied with the oscilloscope or Wi-Fi connection.
-

C. External connections

DANGER

To prevent injury or death, use only the power cord and adaptor supplied with the product.

D. Environment

DANGER

To prevent injury or death, do not use the product in wet or damp conditions, or around explosive gas or vapor.

WARNING

To prevent any damage, always use and store your oscilloscope in appropriate environment.

E. Product Maintenance

The product contains no user-repairable parts. Repair, servicing, and calibration require specialized test equipment and must be performed by Autel Tech Support or an approved service provider.

DANGER

To prevent injury or death, do not use the product if it appears to be damaged in any way. Stop using the product when any abnormal operations occur.

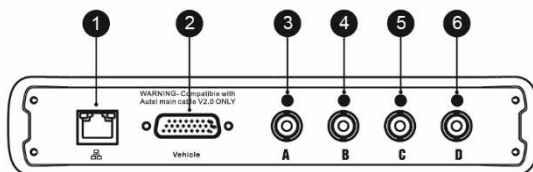
WARNING

- Do not tamper with or disassemble the oscilloscope, connectors or accessories. Internal damage will affect performance.
- Do not block any of the instrument's air vents to avoid damage caused by overheating.
- When cleaning the oscilloscope, use wet soft cloth with mild detergent in water. Do not allow water to enter the oscilloscope casing.

7.1.2 General Introduction

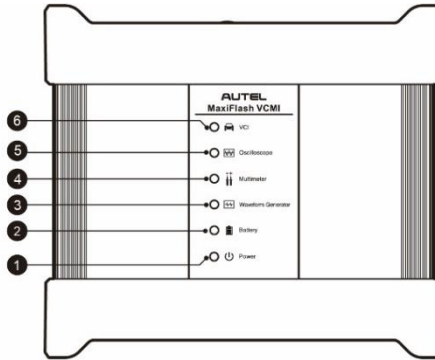
7.1.2.1 Component Locations

The input channels are located at the bottom of the VCMI device and are compatible with many test leads and probes.



1. Ethernet Connector — Connects to RJ45 Network Cable
2. Vehicle Data Connector — Connects to the vehicle DLC using the provided Main Cable.
3. Input Channel A
4. Input Channel B
5. Input Channel C
6. Input Channel D

The oscilloscope LED is located on the front panel of the VCMI device. When the VCMI is properly connected and powered on, the oscilloscope LED flashes green when operating in the oscilloscope mode.



1. Power LED
2. Battery LED
3. Waveform Generator LED
4. Multimeter LED
5. Oscilloscope LED
6. Vehicle LED







7.1.2.2 Technical Specifications


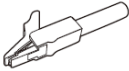
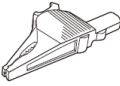
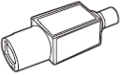



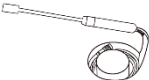
Table 7-1 Technical Specifications

Item	Description
Channels	4
Bandwidth	20 MHz

Item	Description
Maximum Sample Rate	<ul style="list-style-type: none"> ● 1 or 2 channels: 80 MS/s* ● 3 or 4 channels: 20 MS/s* <p>* MS/s = mega samples per second</p> <ol style="list-style-type: none"> 1) Select arbitrary one channel, the maximum sample rate is 80 MS/s. 2) Select two channels (AC, BC, AD, or BD), the maximum sample rate is also 80MS/s. 3) Select two channels (AB/CD) or more than three channels, the maximum sample rate is 20 MS/s.
Input Ranges (Full Scale)	±50 mV to ±200 V
Sensitivity	10 mV/div to 40 V/div
Input Coupling	AC/DC
Input Impedance	1 MΩ in parallel with 25 pF
Vertical Resolution	12 bits
Buffer Memory	32M samples shared among active channels
Time Base Ranges	100 ns/div to 1000 s/div
Connection	<ul style="list-style-type: none"> ● USB 2.0 ● Wi-Fi
Max. Wi-Fi Transmission Distance	Up to 98 ft.
DC Accuracy	±1 % of full scale
Storage Humidity Range	5 to 95 % RH, non-condensing

7.1.2.3 Accessories

	<p>Autel USB Cable V2 (the V2 icon can be seen on the cable) (SA001)</p> <p>Connects the oscilloscope to the tablet to ensure reliable signal transmission.</p>
	<p>Secondary Ignition Pickup (SA273)</p> <p>The BNC connector is connected to the oscilloscope to measure the secondary ignition voltage of conventional ignition systems and most HEI (High Energy Ignition) and DIS (Distributorless Ignition) systems.</p>
	<p>Scope Test Lead</p> <p>(Red: SA005, Green: SA006, Blue: SA007, Yellow: SA008)</p> <p>The BNC connector is connected to the oscilloscope, and the 4mm banana plug is connected to various probes.</p>
	<p>Breakout Lead (SA151)</p> <p>Enables easy access to existing automotive wiring harness connectors for obtaining signals of various sensors. Four sizes are available: 0.6 mm, 1.5 mm, 2.3 mm and 2.8 mm.</p>
	<p>Flexible Back-pinning Probe (Red: SA053, Black: SA054)</p> <p>Designed for back-probing under the insulation of multi-plug terminals to detect the signal of the test component. The flexible part can be bent and access to difficult areas. The probe tip is not replaceable.</p>
	<p>Back-pinning Probe Set (SA051)</p> <p>Designed for back-probing under the insulation of plugs to pick up the signal of the test component. The probe tip is replaceable.</p>

	<p>Multimeter Probe (Red: SA055, Black: SA056)</p> <p>Designed for connecting exposed wires or terminals.</p>
	<p>Small Crocodile Clips (Red: SA057, Black: SA058)</p> <p>Used to connect exposed wires or terminals. SA059 (red) and SA060 (black) for larger terminals.</p>
	<p>Large Dolphin Clips (Red: SA059, Black: SA060)</p> <p>Used to connect exposed wires or terminals, including battery terminals. SA057 (red) and SA058 (black) for smaller terminals.</p>
	<p>Attenuators 20:1 (SA020)</p> <p>Passive 20:1 attenuator, can output 1V when inputting a 20V signal.</p>
	<p>Battery Clip (Optional) (Red: SA061, Black: SA062)</p> <p>Dedicated to connecting car battery terminals.</p>
	<p>65A AC/DC Current Clamp (Optional) (SA253)</p> <p>Used to measure AC or DC currents up to 65A. Two scales are available: 1mV/10mA for 10mA to 20A, 1mV/100mA for 10mA to 65A.</p>
	<p>650A AC/DC Current Clamp (Optional) (SA256)</p> <p>Used to measure AC or DC currents up to 650A. Two scales are available: 1mV/100mA for 100mA to 200A, 1mV/1A for 100mA to 650A.</p>
	<p>Coil On Plug (COP) Probe (Optional) (SA271)</p> <p>Used with the oscilloscope to measure the secondary ignition voltage of COP.</p>



HT Extension Lead (Optional) (SA275)

Fit the HT extension leads between the coil pack and the plugs of the independent ignition system (COP), and then place the (SA273) secondary ignition pickup on each lead to obtain the secondary ignition voltage.

7.1.3 Getting Started

Before opening the Oscilloscope application, the VCMI device must be connected to the tablet via the provided USB cable or Wi-Fi network. For more information, see [Establish Vehicle Communication](#).

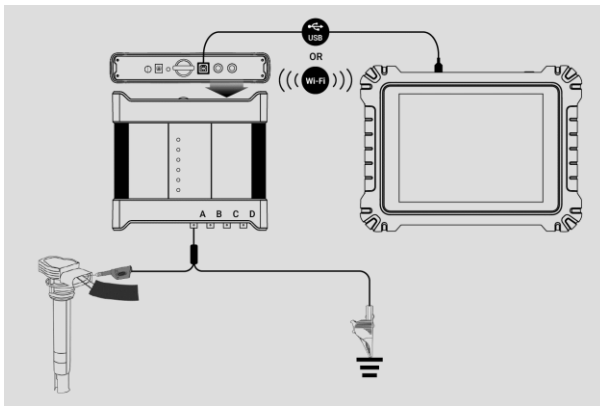


Figure 7-1 Connection Diagram

➤ To open the oscilloscope application

1. Insert the applicable test lead or probe terminal ends into the input channel(s) to complete the connection. (See [Figure 7-1 Connection Diagram](#).)
2. Tap the **Measurement** icon on the MaxiSys Job Menu. The Measurement screen opens.
3. Tap the **Oscilloscope** icon to open the oscilloscope menu.
4. Select a desired testing option to continue.

🔧 NOTE

Please check the oscilloscope LED status indicator on the front panel of VCMI device. The oscilloscope LED flashes green when operating in the oscilloscope mode.

7.1.3.1 Message Prompt

A message showing "Are you sure to open the waveform of Demo mode?" displays after tapping the Oscilloscope icon and opening the oscilloscope menu. Please tap **OK** to enter the demo mode or tap **Cancel** to exit.

A message showing "Are you sure to open the waveform data?" also displays after the tablet and the VCM1 connect successfully. Please tap **OK** to display the actual waveform or tap **Cancel** to exit.

7.1.4 Oscilloscope Update

The operating software for the oscilloscope is regularly updated. Tap the **Help** button in the upper toolbar and then tap the **Update the APK** button in the dropdown list to update the software.

Before updating the oscilloscope's software, please make sure the tablet has a stable Internet connection.

7.1.4.1 APK Update

NOTE

The acronym APK (Android Package Kit) is used on the tablet and in this manual. An APK file contains all the assets of a particular app. Updating an APK means to install the latest version of the app on your tablet.

➤ **To update the APK**

1. Tap the **Help** button on the upper toolbar of the screen. A dropdown menu displays. Tap **Update the APK** in the dropdown menu.

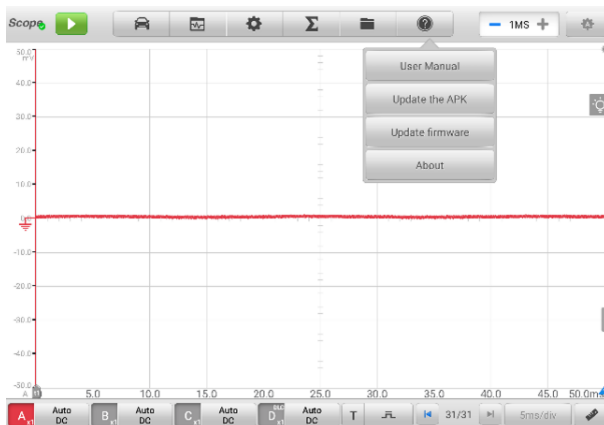


Figure 7-2 Help Screen

2. A confirmation message will display.
3. Tap **OK** to update the software or tap **Cancel** to exit.

7.1.4.2 Firmware Update

➤ To update the firmware

1. Tap the **Help** button on the upper toolbar of the screen. A dropdown menu displays. (See [Figure 7-2 Help Screen](#).)
2. Tap **Update Firmware** in the dropdown list. The screen will switch to the **Update** section in the **VCMI Management** application.

🔗 NOTE

Please disconnect the MaxiScope from the VCMI before update. A message displays, and tap **OK** to confirm that you have disconnected the MaxiScope from the VCMI.

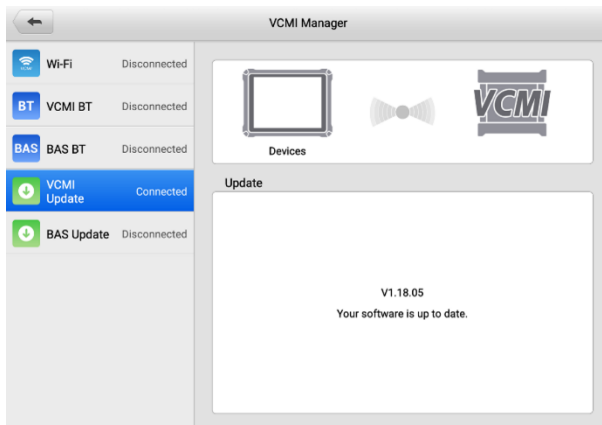


Figure 7-3 Firmware Update Screen

3. If the installed version is not the latest available, the current version and the latest version of the OS, firmware, and scope firmware will appear. Tap **Update Now** to update. Please do not leave the update page during upgrading. It takes about 5–15 minutes for the whole process to complete.

7.1.5 Screen Layout and Operations

The Oscilloscope application measures changing voltages of an electrical system over a period of time. This signal is depicted as a shape. The grid on the screen shows divisions of voltage and time to enable measurements to be made.

Tap the **Measurement** icon on the MaxiSys Job Menu screen then select **Oscilloscope** in the menu, the oscilloscope page displays. The screen typically includes the following sections.

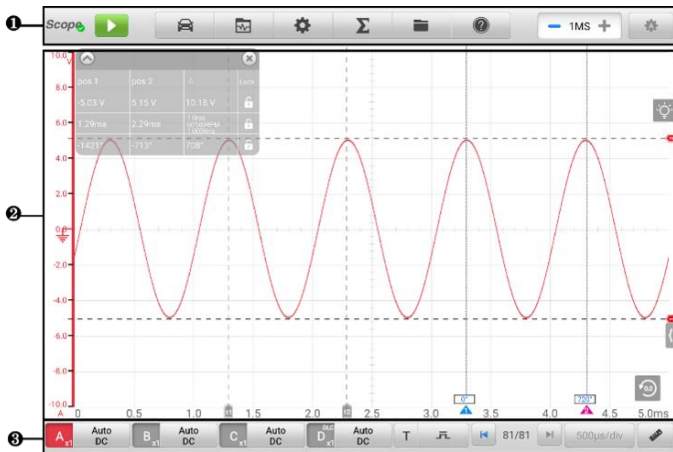






Figure 7-4 Oscilloscope Menu Screen







1. Upper Toolbar
2. Main Section
3. Lower Toolbar

7.1.5.1 Upper Toolbar

The upper toolbar is used for configurations of various settings and operations. The following table provides brief descriptions of each button.

Table 7-2 Upper Toolbar

Button	Name	Description
	Scope Icon	Indicates the oscilloscope connection status.
	Start/Stop	Start or stop the oscilloscope device.
	Presets	Access preset guide. Select preset to correctly configure oscilloscope to capture a waveform of the specified type.
	Waveform Library	Search, upload, share, open, load as reference waveform, and follow the waveforms in the waveform library.



Button	Name	Description
	Settings	Configurations of mode setting, waveform generator, decoding setting, startup setting, and demo setting.
	Math Channel	Tap to display the math channel on the screen.
	File	Print, open, save, delete the waveform data or upload the waveform to waveform library. Moreover, save, import the configuration and open the recent documents.
	Help	View the user manual, update the APK (oscilloscope software) and firmware.
	Number of Samples	Set the maximum number of samples that will be captured on each channel.
	Auto Scale	Set the appropriate amplitude range to display the signal correctly.

- **Scope Icon**

This icon displays the oscilloscope connection status. A green check mark means the tablet and oscilloscope are connected successfully; a red “X” means the tablet and the scope are not connected.

- **Start/Stop Button**

Tap the **Start/Stop Button** icon to start or stop the oscilloscope device.

Button	Name	Description
	Start	Tap to start the oscilloscope and initiate sampling.
	Stop	Tap to stop the oscilloscope and terminate sampling.

- **Presets Menu**

Tap the vehicle icon button in the top navigation bar to enter the **Presets Menu**. This menu offers a wide variety of preset guided information for you to view.

The frequently used test components and options are listed in the Presets menu:

- ❖ **Actuators** — test the common car actuators such as injectors, fuel pumps, and canister purge solenoids.
- ❖ **Battery Charging** — test the functions related to car charging, including current and voltage idle test.
- ❖ **Combination Test** — combined test of the vehicle's sensors or actuators, such as the crankshaft position sensor and camshaft position sensor test; the primary ignition and crankshaft position test; the throttle position sensor and front oxygen sensor test.
- ❖ **Data Communication** — test the vehicle communication buses including CAN-bus, LIN-bus, and K-Line.
- ❖ **Engine Starting** — Test the functions related to car starting, including starting current and voltage test.
- ❖ **Ignition Systems** — test the ignition process of the vehicle, including the voltage and current test of the primary and secondary ignition.
- ❖ **Sensors** — test the common car sensors such as oxygen sensors, camshaft sensors, and crankshaft sensors.

NOTE

Do not connect to HV control signal such as the ignition control wire. It may cause the damage to the product. The measured voltage value during the actuator test may be different from the actual value.

➤ **To use the Presets menu**

1. Tap the **Presets** button in the upper toolbar. A submenu opens.
2. Tap the desired test component or option in the left column.

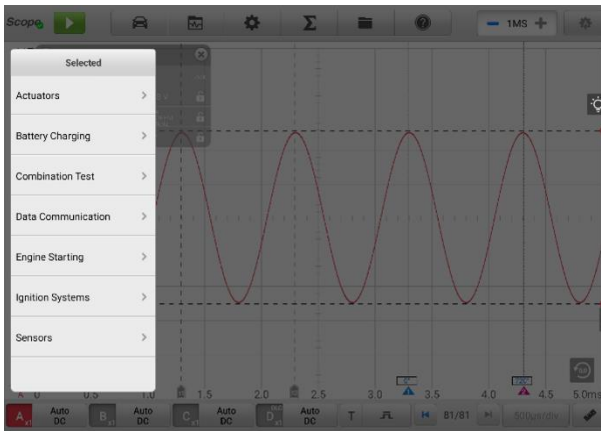




Figure 7-5 Presets Menu Screen 1

- Tap an option you need from the submenu, and if there is no preset case or the version of the preset case is too low, tap the  button to download the new preset case you need. If the current preset case is already a new version, the download button  will not be displayed.

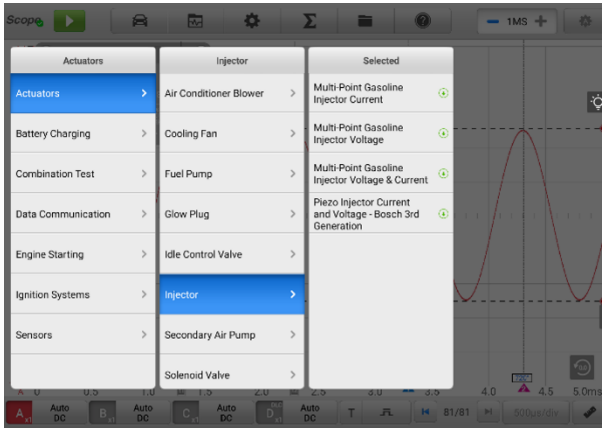


Figure 7-6 Presets Menu Screen 2

- View the preset guided information. A reference signal waveform displays (an injector selection is used here as an example) on the main section and the preset guided information on the right side of the screen.

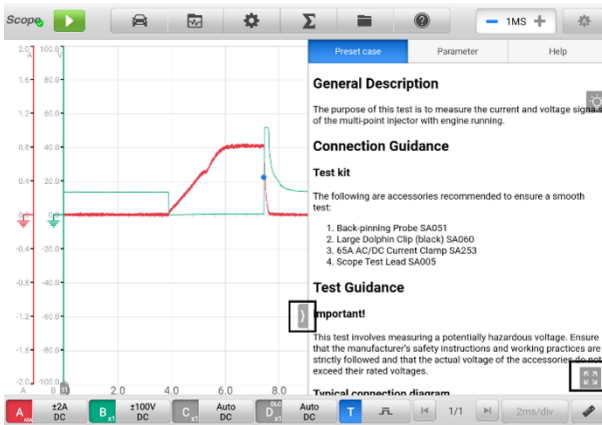


Figure 7-7 Presets Display Screen

- Tap the arrow button to hide the preset guided information and display the

waveform.

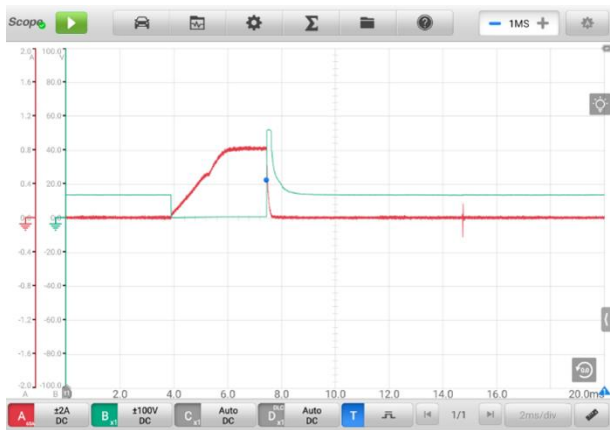


Figure 7-8 Reference Signal Waveform Display

NOTE

Parameter values such as the ranges of voltage and time divisions are automatically set for presets.

6. Tap the four-directional arrow icon in the lower right corner to display the preset guided information, including the general description, connection guidance, connection diagram, test guidance, real vehicle connection, waveform analysis and related DTCs in full screen. Tap again to exit full screen.

NOTE

Images in the preset guided information can be displayed in a full screen for viewing in details.

7. Tap the **Start/Stop** button. The oscilloscope will perform waveform acquisition according to the preset parameters.

- **Waveform Library**

Tap the waveform icon on the upper toolbar to open the Waveform Library Page. The waveform library includes online waveform library and local waveform library.

- 1) **Online Waveform Library**

The waveforms in the online waveform library are picked and uploaded by Autel users during repair and test process using an oscilloscope. It allows you to search for the waveforms from the vehicle and component you want to test, or upload and share your own waveforms.

The search result displays the information such as the waveform picture, waveform ID, VIN code, vehicle code, etc. The waveform in the online library can also be loaded as reference waveform for better waveform analysis.

There are two methods to search for waveforms: Condition-based search and keyword-based search.

❖ **Condition-based Search**

On the condition-based search page, the waveform(s) can be accurately searched after selecting the corresponding conditions, such as the vehicle model, test category, status, etc. Once you have searched a waveform, you can open, share the waveform ID to others, and follow as your favorite.

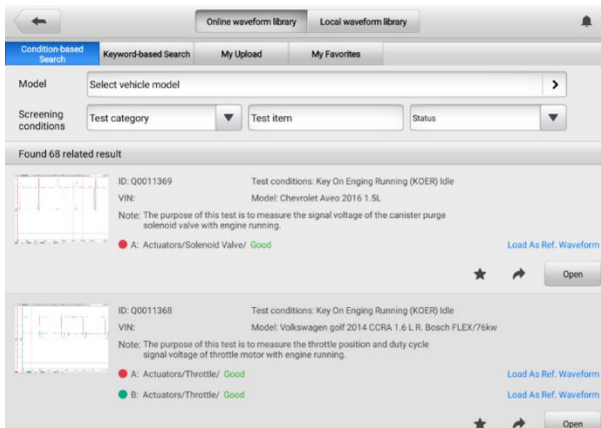


Figure 7-9 Conditional-based Search Screen

✓ **Model**

Tap the input field or the arrow icon on the right to select the vehicle model. The manufacturer and model should be selected from the column that displays.

✓ **Screening conditions**

Three screening conditions are available: Test category, test item, and status.




Tap the dropdown menu to select the test category such as the actuators, battery charging, engine starting, or no selection.

Tap the dropdown menu to select the condition status: no selection, good or bad.

✓ **Search result**

The search result will automatically display in the lower section of the page after selecting the model and conditions, showing the image of waveform, waveform ID, VIN or the screening conditions.

Tap the corresponding buttons on the lower right side to share, follow or open the waveform. Tap the **Load As Ref. Waveform** to load the waveform as a reference waveform for better waveform analysis.

Button	Name	Description
	Share	Tap to display a waveform ID and you can share it through Twitter or Facebook to anyone you want.
	Favorite	Tap to add the waveform to your favorites.
	Open	Tap to open the waveform.

✧ **Keyword-based Search**

On the keyword-based search page, please input the waveform ID, VIN, vehicle code, or screening conditions and then tap the "Search" button to roughly search the waveform(s) you want. You can also scan the waveform code or VIN by tapping the Scan icon in the input field to search the waveform.

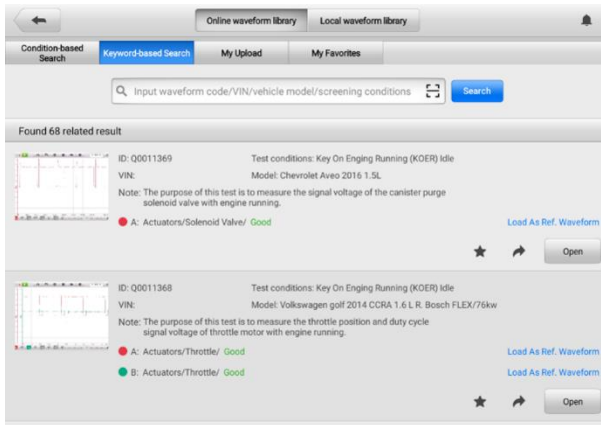


Figure 7-10 Keyword-based Search Screen

✧ My Upload

Your own waveforms can be saved and uploaded to the online server. The uploaded waveforms can be searched from "My Upload" tab.

Please input the waveform code, VIN, vehicle code, or screening conditions and then tap the **Search** button to search the waveform(s) you have uploaded. The waveform can be opened, shared, followed, reviewed, and loaded as a reference waveform once you have found it.

✧ My Favorites

All the waveforms you have searched in the Condition-based Search, Keyword-based Search or My Upload tab can be followed as My Favorites by tapping the five-point start button. The waveform can also be opened, shared, followed and loaded as a reference waveform.

2) Local Waveform Library

The waveforms in the local waveform library are the ones saved in the tablet.

Input the waveform code, VIN, vehicle code, or screening conditions and then tap the **Search** button to search the waveforms saved in the local library. The found result displays the picture of waveform, waveform ID, screening conditions, vehicle model, etc. The waveforms can be opened, loaded as reference waveforms, shared waveform codes, uploaded or batch uploaded.

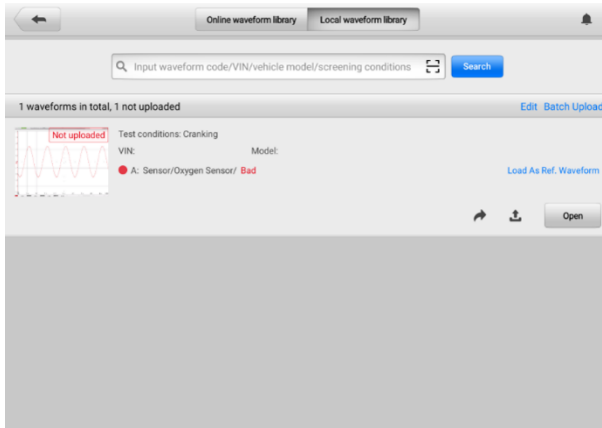


Figure 7-11 Local Waveform Library Screen

- **Settings Menu**

Tap the gear icon button in the upper toolbar to open the **Settings** Menu. The **Mode**, **Window Function**, **Waveform Generator**, **Decoding Settings**, and **Startup Setting** can be manually configured in the menu.

- A. Mode**

Four views are available: oscilloscope view, record view, XY view, and spectrum view.

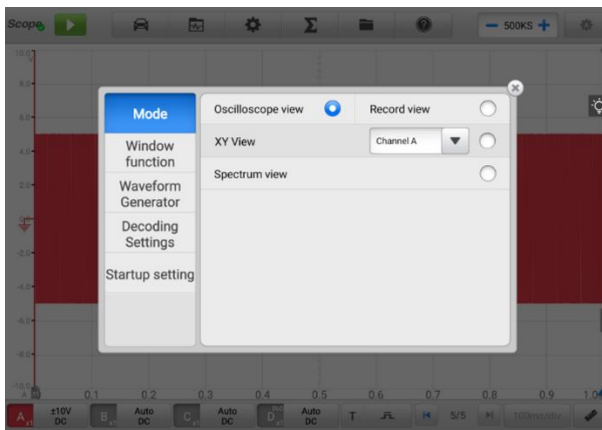


Figure 7-12 Mode Setting Screen

- ✓ **Oscilloscope View:** the waveform shows how a signal varies with time in a graphical way.
- ✓ **Record View:** the waveform records signal and shows signal record.
- ✓ **XY View:** the waveform shows the relationships between periodic signals, displaying a graph of one channel against another.

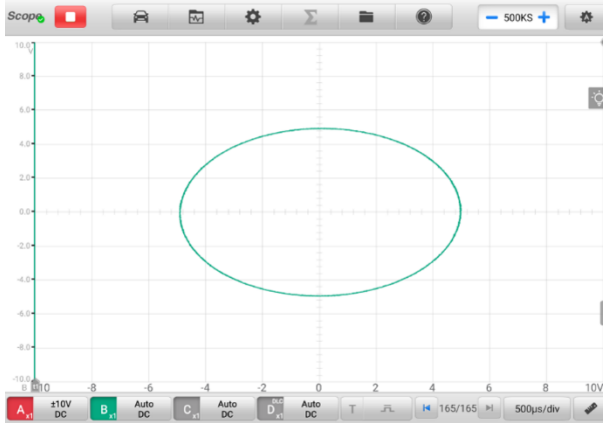


Figure 7-13 XY View Setting Screen

- ✓ **Spectrum View:** the waveform shows the signal level on a vertical axis against frequency on the horizontal axis in a graphical way. One or more spectra with a common frequency axis can be displayed in the spectrum view.

NOTE

The Wi-Fi connection does not support the XY View and Spectrum View. Please use the USB cable to connect the device, instead of the Wi-Fi connection.

The spectrum-related analysis options display after selecting the spectrum view in the Mode setting screen. Select the desired spectrum bins and window functions for better spectrum analysis.

The amplitude over-range of Y-axis can be adjusted by the amplitude level. When the sampling frequency is low, the current frequency can also be adjusted. The maximum frequency supports 20 M.

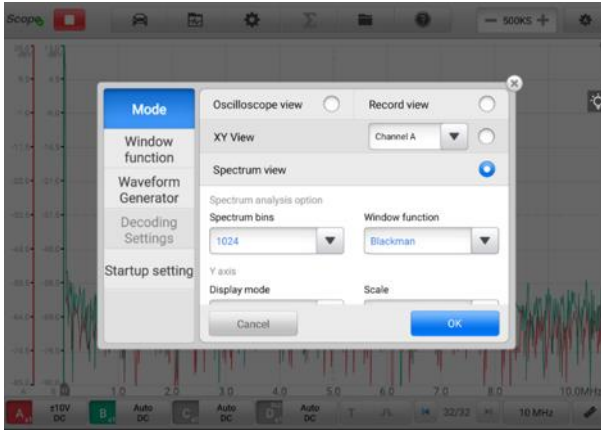


Figure 7-14 Spectrum View Setting Screen 1

✧ **Spectrum Analysis Option**

Spectrum Bins: it allows you to set the number of frequency bins into which the spectrum is divided.

Window Function: it allows you to select one of the standard window functions to reduce the impact of running on a time-limited waveform.

Table 7-3 Window Function Table

Window	Main peak width (bins @ -3 dB)	Highest side lobe (dB)	Side lobe roll-off (dB/octave)	Description
Rectangle	0.89	-13.2	6	No fading; maximal sharpness; used for short transients.
Blackman	1.68	-58	18	Often used for audio work.
Blackman-Harris	1.90	-92	6	Used for general purpose.
Flattop	2.94	-44	6	Negligible pass-band ripple; mainly used for calibration.

Window	Main peak width (bins @ -3 dB)	Highest side lobe (dB)	Side lobe roll-off (dB/octave)	Description
Gauss	1.33 to 1.79	-42 to -69	6	Gives minimal time and frequency errors.
Hann	1.20 to 1.86	-23 to -47	12 to 30	Used for audio and vibration work.
Hamming	1.30	-41.9	6	Also called raised sine-squared; used for speech analysis.
Triangle	1.28	-27	12	Also called Bartlett window.

✧ **Y-axis**

Display Mode: Magnitude Mode displays the frequency spectrum of the last waveform.

Scale: the scaling of the vertical axis.

Logarithm: the vertical axis is scaled in decibels.

Linear: the axis is scaled in equal intervals from DC to the frequency.

Logarithmic Unit: the reference quantity used for the logarithm scale.

Table 7-4 Logarithm Unit Specifications

Logarithmic Unit	Description
dBV	Reference level is 1 V.
dBu	Reference level is 1 mW with a load resistance of 600 Ω .
dBm	Reference level is 1 mW into the specified load impedance.
Any dB	Reference level is an arbitrary voltage.

✧ **X-axis**

Scale: the scale of the frequency axis.

Linear: the axis is scaled in equal intervals from DC to the frequency.

➤ **To set the Spectrum View**

1. Tap the **Settings** button on the upper toolbar. A dialog box opens.
2. Select the **Mode** option in the dialog box, and then tap to select **Spectrum View**.
3. Tap the input field or the dropdown arrow icon to select the desired options from the column. Tap **OK** to confirm.

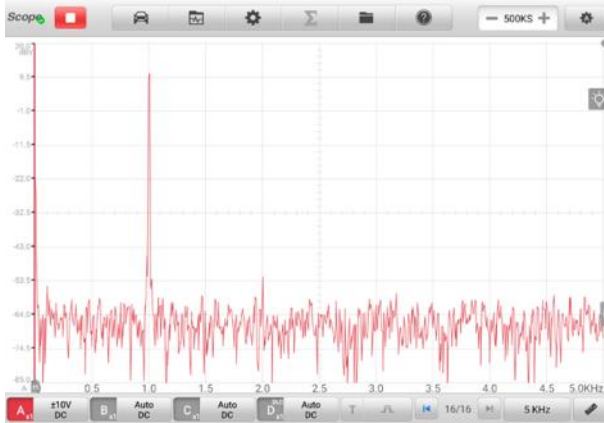


Figure 7-15 Spectrum View Setting Screen 2

B. Window Function

A display window with grid displays the data captured by the oscilloscope. By default, a single trace is displayed. Additional traces can be added via the window display menu.

✧ **Display Mode**

The Window Function menu allows you to configure up to four traces.

Single Window — displays a single trace.

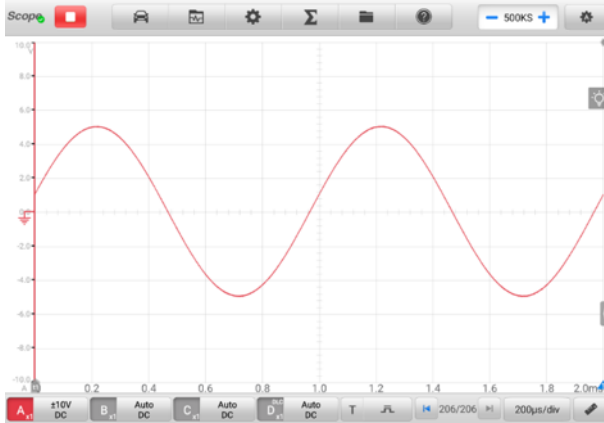


Figure 7-16 Single Window Screen

Double Window — displays two separate traces horizontally, one below the other.

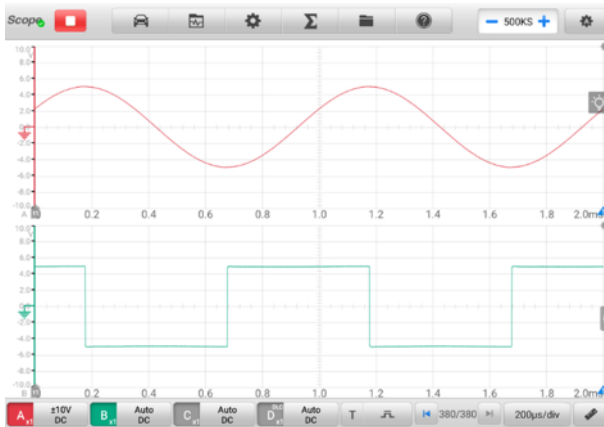


Figure 7-17 Double Window Screen

Triple Window — displays three separate traces horizontally, one below the other.

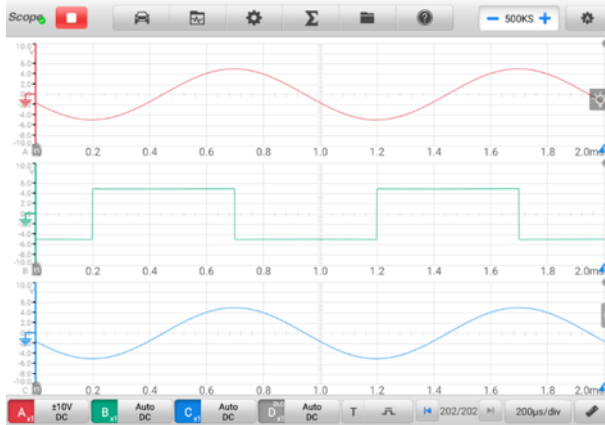


Figure 7-18 Triple Window Screen

Quadruple Window — displays four separate traces, two horizontally, two vertically.

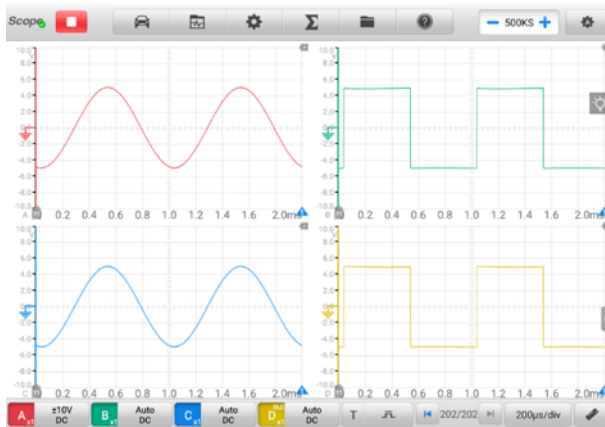


Figure 7-19 Quadruple Windows Screen

➤ **To set the display mode**

1. Tap the **Settings** button in upper toolbar. A dialog box opens.
2. Select the **Window Function** in the dialog box.
3. Tap the appropriate number icon to display the corresponding number of traces onscreen.

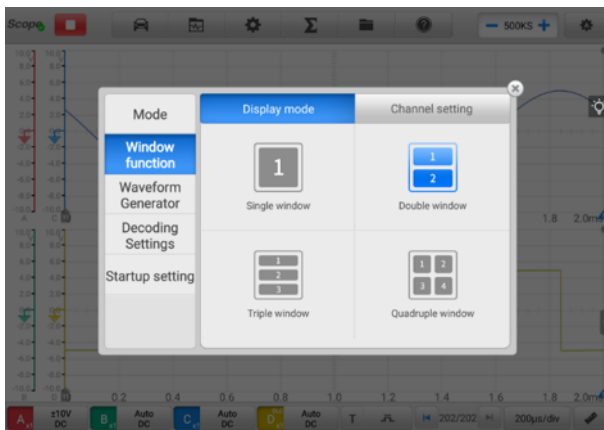


Figure 7-20 Display Mode Selection Screen

4. Close the dialog box. The window is displayed as selected.

❖ **Channel Setting**

The Channel Setting allow you to arrange the display position of the activated channels. Select which channels are visible in the display window. The display status is set to **ON**, the input channels are enabled, otherwise, the input channels (set to OFF status) are not available for viewing.

➤ **To set the channel setting**

1. Tap the **Settings** button in upper toolbar. A dialog box opens.
2. Select the **Window Function** in the dialog box, then select **Channel Setting**.
3. Swipe the display status icon to **ON**. Select the position for each channel from the dropdown menu.

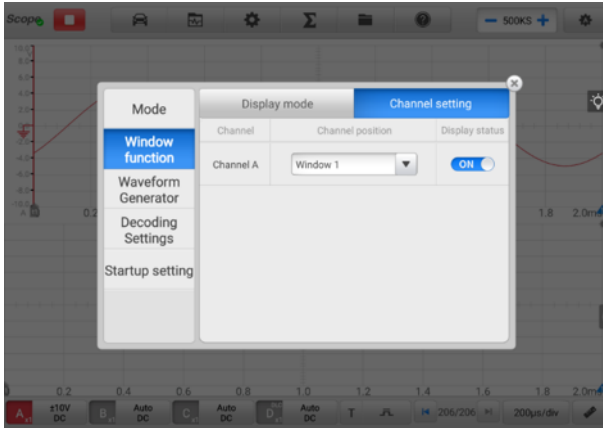


Figure 7-21 Channel Setting Screen

4. Close the dialog box and the activated channel is displayed in the selected window.

C. Waveform Generator

The Waveform Generator operates simultaneously with the oscilloscope. Use the waveform generator to simulate the DC voltage, square wave, square wave (X+Y), triangle wave, and actuators drive.

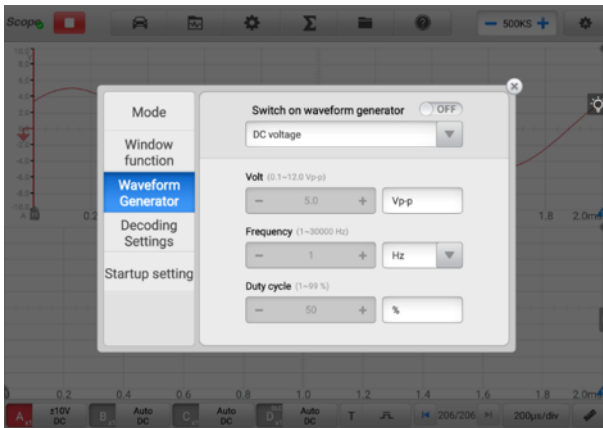


Figure 7-22 Waveform Generator Screen

➤ **To set the waveform generator**

1. Tap the **Settings** button in the upper toolbar. A dialog box opens.
2. Select the **Waveform Generator** option in the dialog box.
3. Swipe the **OFF** to **ON** to enable the waveform generator. Select a desired option from the dropdown menu. Tap the "+" or "-" buttons to adjust the voltage, frequency and duty cycle values.
4. Close the dialog box. The waveform generator settings are displayed on the screen.

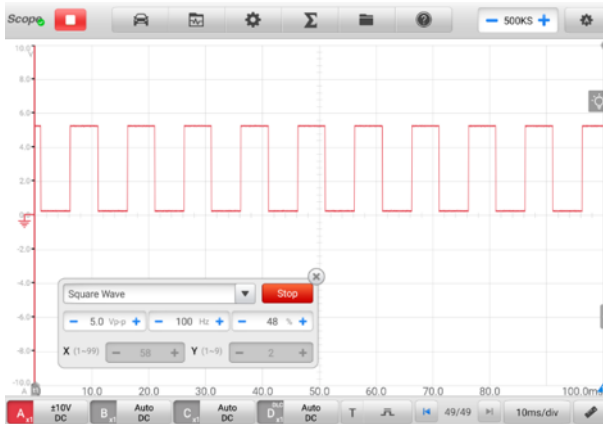


Figure 7-23 *Waveform generator Display Screen*

D. Decoding Settings

When the oscilloscope mode is selected, the decoding settings are available.

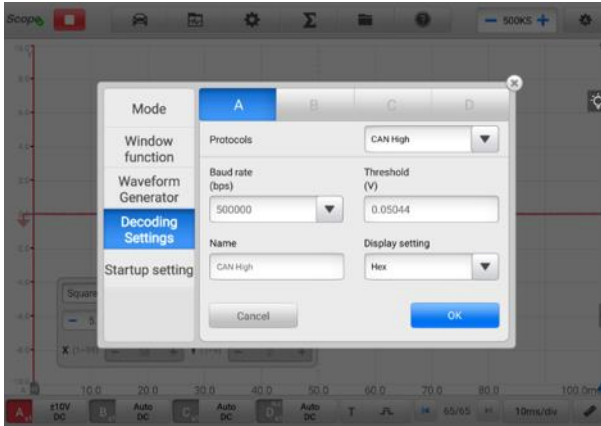


Figure 7-24 Decoding Settings Screen 1

9 Protocols are available: CAN High, CAN Low, LIN, FlexRay, RS232/UART, I2S, I2C, USB (1.0/1.1), and CAN FD. The detailed setting options vary according to each protocol.

- ✧ **CAN High/CAN Low:** Controller Area Network (CAN) is a serial protocol used in automotive to allow microcontrollers to communicate with each other. It typically uses differential signaling (with signals named CAN High and CAN Low) to increase noise immunity.
- ✧ **LIN:** Local Interconnect Network (LIN) is a serial protocol used in automotive electronics to allow microcontrollers to communicate with low-speed peripherals.
- ✧ **FlexRay:** It is an automotive network communications protocol for high-speed data.
- ✧ **RS232/UART:** Universal Asynchronous Receiver/Transmitter (UART) is the communication interface found in the serial or COM ports once commonly found on computers. Each channel of data is transmitted on a single wire pair using an electrical standard such as RS232.
- ✧ **I2S:** Inter-IC Sound (I2S) is a serial protocol used in digital audio devices for communications between circuits such as CD transports and audio DACs.
- ✧ **I2C:** Inter-Integrated Circuit (I2C) is a way to connect peripheral chips in consumer electronics products and is widely used in embedded systems.
- ✧ **USB (1.0/1.1):** Universal Serial Bus (USB) is widely used in personal computers

and tablets for communication.

- ✧ **CAN FD:** The CAN FD serial protocol is an extended version of the Controller Area Network (CAN), which allows electronic controllers to receive sensor messages and transmits control messages faster than traditional CAN communication.

Baud Rate: The baud rate will display a default value, which needs to be manually set according to the actual signal to get the correct decoding result.

Threshold: The voltage that defines the transition in either direction between high logic state and low logic state.

Name: The name of the protocol that you have selected above. The channel and the corresponding protocol name will display in the scope view after selection.

Display Setting: You can also choose a display mode for the decoded data: Hex or Binary.

➤ **To make the decoding settings**

Using **CAN High** as an example.

1. Tap the **Settings** button in the upper toolbar. A dialog box opens.
2. Select the **Mode** option in the dialog box and tap the **Oscilloscope Mode**.
3. Select the **Decoding Settings** in the dialog box.
4. Select the channel(s) that you want to set, and then select the **CAN High** protocol from the dropdown list.
5. For the baud rate and threshold, you can keep the displayed values or manually enter a value according to the actual signal.
6. Select the **Hex or Binary** display mode from the dropdown list.
7. Tap **OK** to confirm. The decoding settings are displayed on the screen.

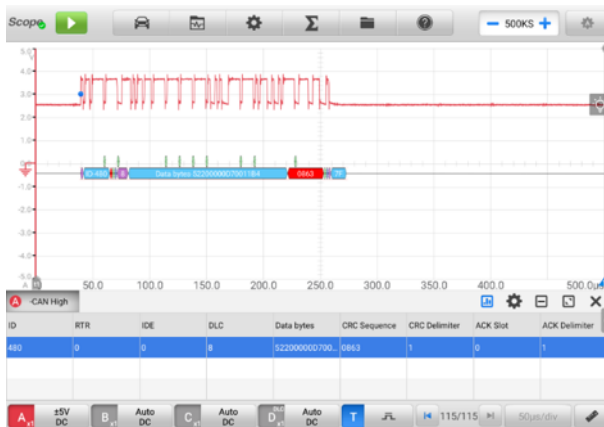


Figure 7-25 Decoding Settings Screen 2

E. Startup Setting

This function allows the user to choose the startup configuration when launch the oscilloscope application.

On the Startup Setting screen, there are three options: **Load user default configuration at startup**, **Load last session configuration at startup**, and **Load factory configuration at startup**. Select one option according to the specific need.

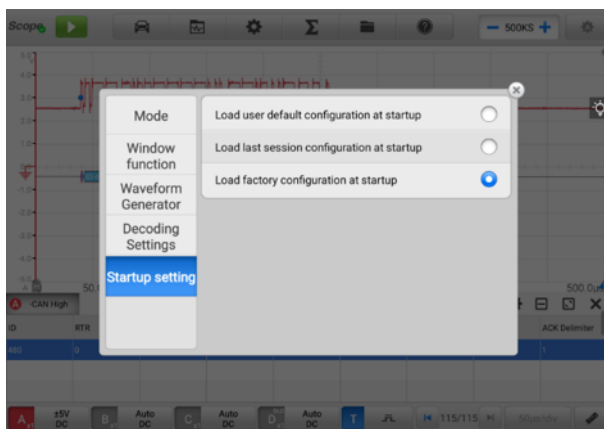


Figure 7-26 Startup Settings Screen

- **Math Channel**

A math channel is a virtual channel generated by a mathematical function of the input channel. It can be displayed in an oscilloscope in the same way as an input signal, and like an input signal it has its own measure axis, scale and color.

The oscilloscope has a set of built-in math channels:

- ✓ **Turnover:** reverses the signal polarity to turn the waveform upside down on the screen
- ✓ **A+B:** channel A plus channel B
- ✓ **A-B:** channel A minus channel B
- ✓ **A*B:** multiply channel A by channel B
- ✓ **A/B:** channel A divided by channel B
- ✓ **Frequency:** the frequency of the signal
- ✓ **Pulse Width (+):** the positive pulse width
- ✓ **Pulse Width (-):** the negative pulse width
- ✓ **Duty Cycle (+):** the positive duty cycle
- ✓ **Duty Cycle (-):** the negative duty cycle

ⓘ **NOTE**

When connecting via Wi-Fi, it only supports Turnover, A+B, A-B, A*B and A/B.

➤ **To set the math channel**

Using **Invert A** as an example.

1. Tap the **Math Channels** icon in the upper toolbar. A dialog box opens.
2. Select **Existing** in the dialog box.
3. Select **Invert A**, and tap **OK** to continue.

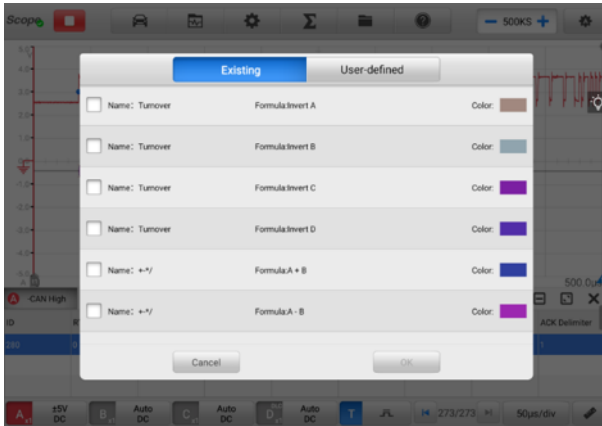


Figure 7-27 Math Channel Setting Screen 1

4. The waveforms are displayed on the screen.

- **File Menu**

The File Menu allows you to print, open, save, and delete the waveform data. The File Menu supports the following functions.

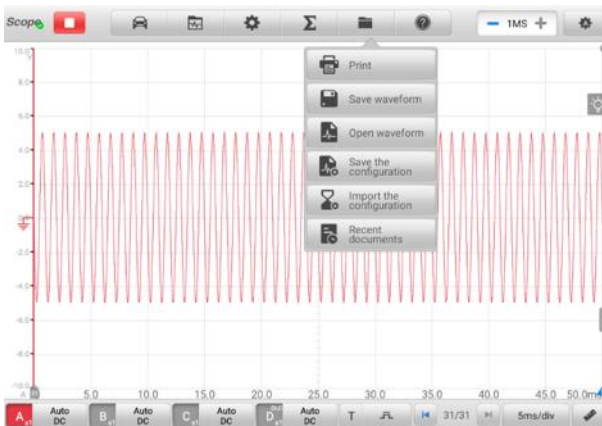


Figure 7-28 File Menu Screen

- ✓ **Print** — tap to create and print a temporary PNG picture of the current waveforms.
-

 **NOTE**

1. Make sure the tablet is properly setup to print and is connected to the printer.
 2. Make sure the network is available.
-

- ✓ **Waveform Operation**

This section allows you to save and open the waveforms.

Save waveform — tap to save the waveform on the current screen. Three types of file saving are available in the dropdown list: **Oscilloscope data file**, **Text file**, and **Excel file**. Select one of the file saving ranges from **save current page**, **save last 5 pages** and **save all pages**. Finally tap the **Save** button to save the waveform.

Select the Text File option to save the current waveform data to a text file. Use the ES File Explorer app on the Android home screen to review file: **Home > ES File Explorer > Local > Internal Storage > Scan > Data > Scope > txt**.

Open waveform — tap to retrieve the saved waveforms.

- ✓ **Configuration Operation**

The configurations can be saved and imported, or set to default.

Save the configuration — tap to save the configuration values of waveforms on the current screen including the amplitude, the time base, the number of samples, etc.

Import the configuration — tap to import the saved configuration values of waveforms. Tap the System Default Configuration option to cancel the current setting values and refresh the screen to retrieve the default setting values.

- ✓ **Recent documents** — tap to open the recent documents in order to view the waveforms currently opened in the waveform library.

- **Help Menu**

The Help Menu displays the user manual, update the APK and firmware, and view version numbers of the installed APK and firmware.

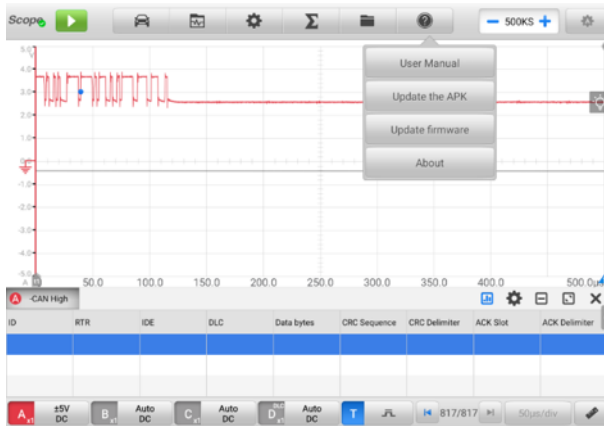


Figure 7-29 Help Menu Screen

- ✓ **User Manual** — displays instruction for the proper use of the oscilloscope.
- ✓ **Update the APK** — connects to the Autel server and to get the latest application software version.
- ✓ **Update Firmware** — connects to the Autel server and to get the latest firmware version.
- ✓ **About** — displays the model number and the installed versions of the software and firmware.

- **Number of Samples**

This button allows you to set the maximum number of samples that will be captured by each channel. The sampling rate of current time base can be adjusted by changing the number of samples. Tap the minus or plus icon to adjust the number of samples.

- **Auto Scale**

Use the **Auto Scale** button to trigger the device to automatically analyze the signal of the opened channel, and automatically set the appropriate amplitude and time base range to display the signal correctly. In auto scale setting, the time base is only valid for periodic signals.

7.1.5.2 Main Section

Up to four traces, along with digital readouts of current signal values, signal status and triggering conditions, can be displayed simultaneously on the main view section screen.

Each trace has two control features, **X-axis** and **Y-axis**, which enable you to adjust the oscilloscope settings to suit the particular test measurement. If multiple traces are displayed at the same time, the **Y-axis** for each trace is adjusted separately while the **X-axis** is the same for all traces.

- ✓ **Y-axis** — the voltage level is recorded on the vertical. It displays on the left side of the screen.
- ✓ **X-axis** — time is presented on the horizontal line. It is shown along the bottom of the screen.

- **Measurement Overrange Indicator**

When the amplitude exceeds the measurement input range, a **red overrange indicator** with the message "**overrange**" is displayed in the top left corner of the screen. Exceeding the common-mode input range may result in inaccurate measurements and can lead to severe signal distortion.

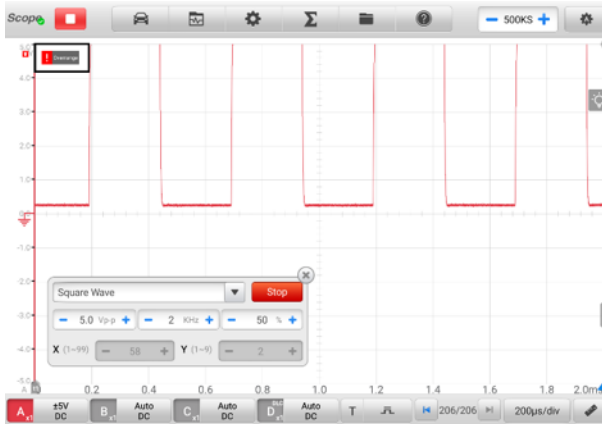


Figure 7-30 Overrange Indicator Screen

Select an appropriate scale setting for the signal being sampled to avoid an overrange condition.

! IMPORTANT

To prevent electric shock, do not exceed voltage limits between inputs

● Channel Selection

In the main view section, a channel has two conditions: selected and unselected. A channel must be selected in order for the waveform to be movement, to use the zoom-in or to add measurement rulers.

Tap the Zero Baseline marker or the Y-axis (the line thickens when selected). After the channel is selected, the waveform can be zoomed. Tap the counterclockwise arrow button at the right corner to recover after zoomed.

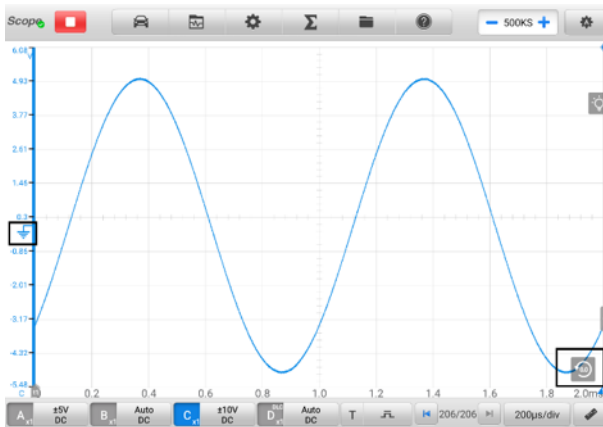


Figure 7-31 Channel Selection 1 (Selected)

Tap the Zero Baseline marker or the Y-axis again to exit the channel selection.

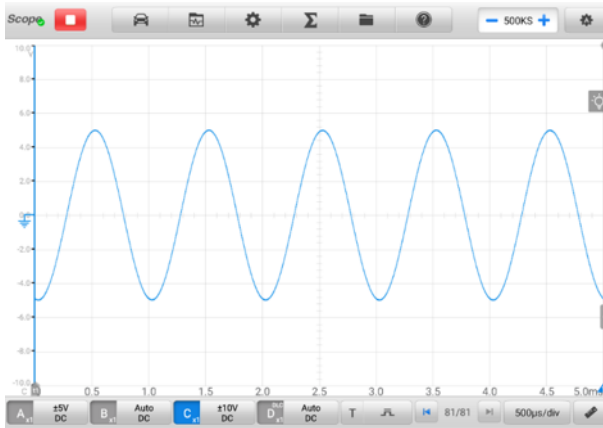


Figure 7-32 Channel Selection 1 (Unselected)

- **Waveform Zooming**

The zooming function allows you to change the size and position of a signal during or after capturing a waveform to examine it in greater details. It does not change the stored data, but the way it displays.

The X-axis and Y-axis can be zoomed using your fingertips. The waveform can be zoomed during or after capturing the signal.

- **Measurement Rulers**

The coordinate Rulers allow the amplitude and time duration of a waveform to be measured precisely. They are useful when determining signal characteristics such as amplitude at specific points, the cycle time (duration) and frequency.

There are three types of measurement rulers: the vertical **Time Ruler**, the horizontal **Signal Ruler**, and the vertical **Angle Ruler**.

Tap the **Ruler Activator** in the lower left corner of the grid and drag it across the screen to the desired position. A **Time Ruler** is generated.

Tap the **Ruler Activator** in the lower right corner of the grid and drag it across the screen to the desired position. An **Angle Ruler** is generated.

The two angle rulers are positioned to mark the start and end of a cycle. By default, the start and end angle values are 0° and 720° , which can be configured in the Phase Setting box.

The **Signal Ruler** can be generated in the similar way by tapping the **Ruler Activator** in the upper right corner and dragging it downwards.

When dragging the Measurement Rulers, a **Ruler Table** showing time and voltage values for the corresponding channels will be displayed. The **Delta** icon refers to the absolute difference between the values of the rulers, which can be locked by tapping the **Lock** icon. Tap the **X** button in the upper right corner of the ruler table to delete all rulers.

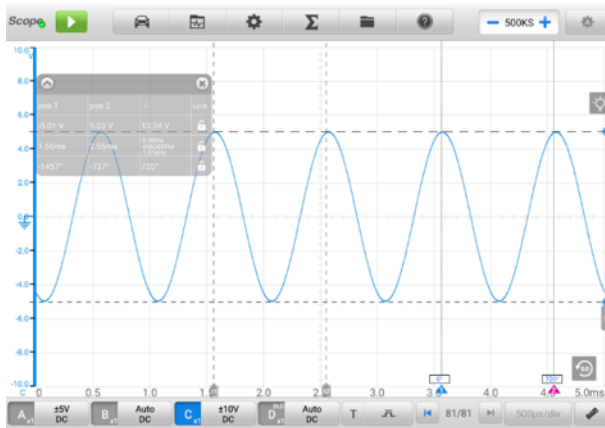


Figure 7-33 Rulers Display Screen

➤ **To configure angle settings**

1. Drag **Angle Activator** to generate the angle rulers.
2. Tap the start or end angle value to open the Phase Setting box.
3. Input the desired phase value and the ruler value in the field.

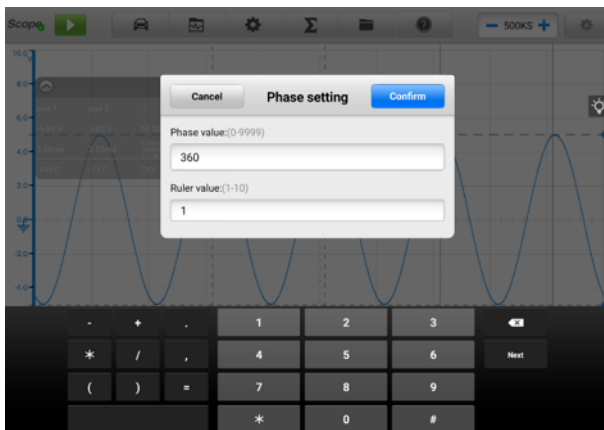


Figure 7-34 Phase Setting Screen

4. Tap **Confirm** in the upper-right corner to save the settings, or tap **Cancel** to exit without saving.
- **Zero Baseline**

The zero baseline is marked the 0 value in the Y-axis, showing the ground level of each channel waveform.

After the channel is selected, the Zero Baseline can be adjusted by dragging the Zero Baseline marker up/down along the Y-axis, or dragging the waveform up/down, or moving the screen up/down in the grid.

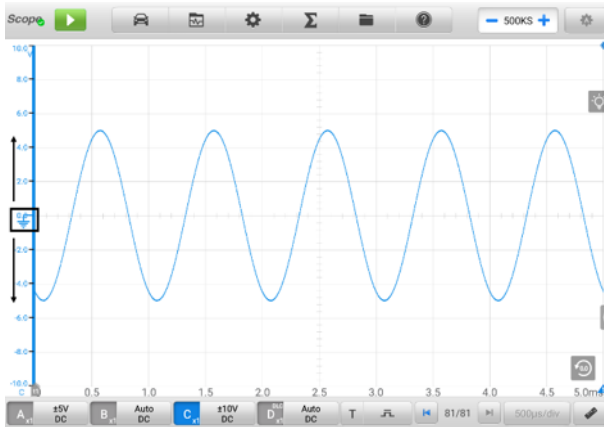


Figure 7-35 Dragging Zero Baseline Marker Screen

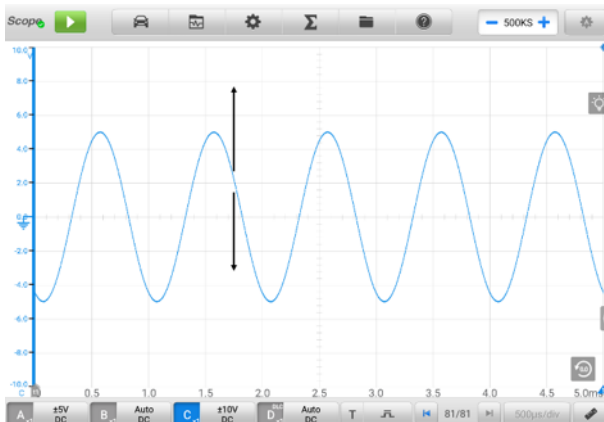


Figure 7-36 Dragging Waveform or Moving Screen

NOTE

To reposition waveform or to move the screen, tap the Zero Baseline marker to select. The line will display thicker when selected.

- **Parameter and Help**

Tap the arrow button in the lower-right corner of the screen to open the Parameter and Help windows.

The **Parameter** function allows you to view the values of parameters including sampling interval, sampling rate, sample size, channel, range, and coupling mode.

The **Help** function displays the user manual of the oscilloscope. The Help page also displays when selecting the Help and User Manual buttons on the upper toolbar. The help information can be full-page shown by tapping the four-directional arrow icon in the lower right corner.

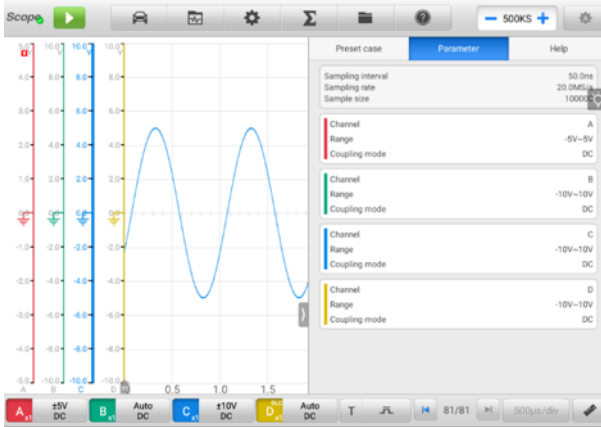


Figure 7-37 Parameter Screen

➤ **To open or close the parameter and help window**

1. Tap the arrow button on the right-hand side of the screen.

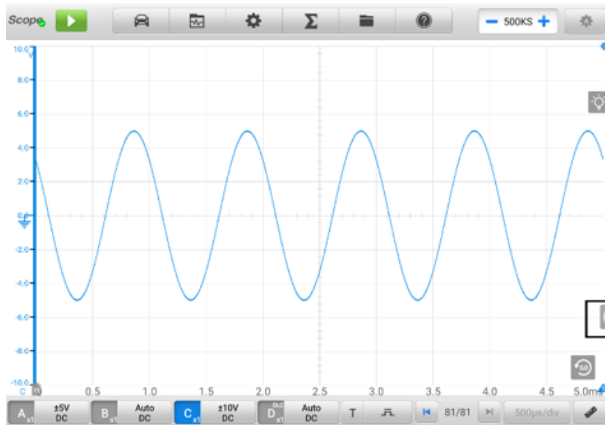


Figure 7-38 Arrow Button Position Screen

2. The parameter and help window appear.
3. To close, tap the arrow button again or tap any space outside of the window.

 **NOTE**

The preset guided information is also displayed on the right side of the screen when the specific options and test components have been selected from the Presets menu.

● **Real-time Help**

The real-time help button is a bulb-shaped button that can be dragged and moved on the screen.

Tap this real-time help button to directly switch to display all the relevant introduction and test procedure information after you tap any function on the oscilloscope screen, for better understanding the selected function.

➤ **To view the real-time help information**

Take the Presets function as an example.

1. Tap the **Presets** button on the upper toolbar to open the preset menu.
2. Tap the bulb-shaped real-time help button. All the information about the Presets Menu is displayed on right side of the screen.
3. View the information by dragging it up and down using your fingertips. The real-time help information can be displayed in a full screen by tapping the four-

directional arrow icon in the lower right corner. Tap it again to recover the half-screen display.

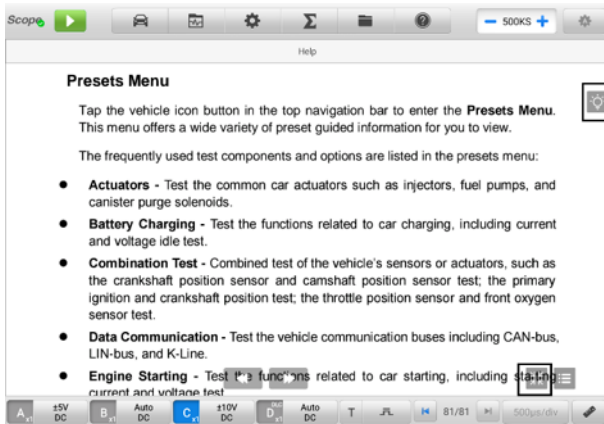



Figure 7-39 Real-time Help Screen (Full Screen)

7.1.5.3 Lower Toolbar

The buttons in the lower toolbar include the channel control buttons, trigger setting buttons, buffer button, time base button and measurement button. The following table provides brief description of each button.

Table 7-5 Lower Toolbar

Button	Name	Description
	Channel Control	Tap to configure the settings of each channel. Active channel icons display in color; inactive icons display in gray.
	Trigger	Tap to open the trigger setting menu.
	Buffer	Tap the Back or Next button to scroll to the previous or the next frame in the waveform.
	Time Base	Tap to select an appropriate time per division.

Button	Name	Description
	Measurement	Tap to select an appropriate measurement.

- **Channel Control**

There are four input channels: **input channel A**, **input channel B**, **input channel C**, and **input channel D**. The four channel buttons display on the lower left side of the screen. Set the input channel(s) through the corresponding channel control button(s).

Each **Channel Control** button includes Amplitude Setting, Probe Setting, Probe Edit, and Low-pass Filtering. The probe name is displayed in the lower-right corner of the left column of the channel control button. The amplitude is displayed in the right column of the channel control button.

- **To activate and close the channel**

1. Tap the left column of the channel control button to activate the channel. The button color changes from gray to the corresponding color of the channel.
2. Tap the right column of the channel control button to open the settings dialog box.

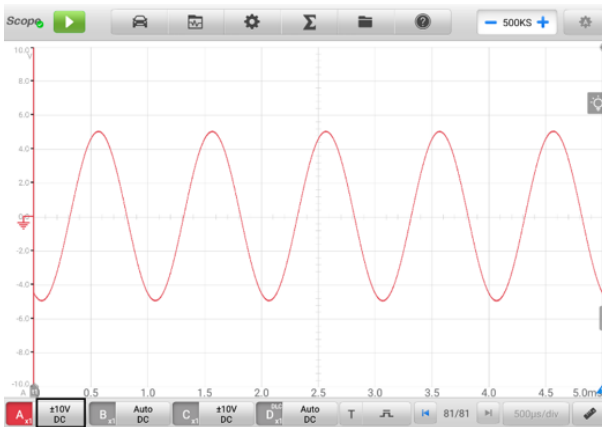


Figure 7-40 Activate Channel Screen

3. Tap the left column of channel control button again to close the channel. The closed channel button displays gray.

◇ **Channel Color**

Identify each channel waveform by color.

Table 7-6 Channel Color Table

Input Channel	Color
A	Red
B	Green
C	Blue
D	Yellow

◇ **Amplitude Setting**

The amplitude, probe, and low-pass filtering settings can be configured in the Channel control dialog box.

The amplitude setting allows you to set up the oscilloscope to capture signals with the specified range. If the input signal exceeds the selected range, an over-range indicator will be displayed. Select **Auto** to enable the device to adjust the vertical scale automatically.

The vertical scale will be changed, while the horizontal scale will not be changed. AC and DC voltage can be toggled to set up the input circuitry.

⊗ **NOTE**

The vertical scale is ALWAYS divided into 10 major divisions, and all scale settings reflect in these 10 divisions. The division set of 10 cannot be changed.

There are two modes available to set the amplitude value.

Mode 1: For example, selecting **DC 5 V** sets the channel amplitude to ± 5 DC (displayed on the right side of the channel control button), the vertical scale range is from -5 V to +5 V. The vertical scale is divided into 10 segments, each segment increases by 1 V.



Figure 7-41 Amplitude Setting Screen (DC 5 V)

Mode 2: Select the **## /div** button to adjust value incremented by each division. For example, selecting **DC 1.0 V/div**, sets the channel amplitude to 1.0 V/div DC (seen at the right side of the channel control button). Each segment increases by 1 V. As the vertical scale is divided into 10 segments, the entire vertical scale range is from -5 V to +5 V.



Figure 7-42 Amplitude Setting Screen (DC 1.0 V/div)

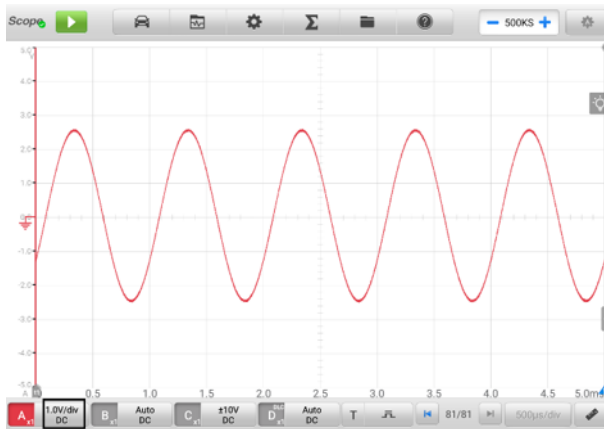


Figure 7-43 Amplitude Setting Screen (DC 1.0 V/div)

✧ Probe Setting

A probe is an accessory that connects to your oscilloscope and to detect signals to be measured.

This oscilloscope has built-in definitions of standard probes. By default, the probe is set to be x1, which means 1V signal at the input to the probe will display as 1V.

The inner probes (built-in probes) include:

- ✓ **X1**: no attenuation
- ✓ **10 : 1 Attenuator**: select when using a 10-fold attenuation probe
- ✓ **20 : 1 Attenuator**: select when using a 20-fold attenuation probe (SA020)
- ✓ **X1000**: select when using a 1,000-fold attenuation probe
- ✓ **65 A Current Clamp (1 mV/10 mA mode, Max: 20 A)**: 1 mV/10 mA mode on 65 A current clamp, the max. current is 20 A
- ✓ **65 A Current Clamp (1 mV/100 mA mode, Max: 65 A)**: 1 mV/100 mA mode on 65 A current clamp, the max. current is 65 A
- ✓ **650 A Current Clamp (1 mV/100 mA mode, Max: 200 A)**: 1 mV/100 mA mode on 650 A current clamp, the max. current is 200 A
- ✓ **650 A Current Clamp (1 mV/1 A mode, Max: 650 A)**: 1 mV/1 A mode on 650 A current clamp, the max. current is 650 A
- ✓ **Coil-On-Plug Ignition Probe [COP]**: select when using the COP ignition probe (SA271)

- ✓ **Secondary Ignition Probe [ignition]:** select when using the secondary ignition probe (SA273)
- ✓ **Secondary Ignition Probe (inverted) [R_ignition]:** select when using the secondary ignition probe (SA273) and inverting the secondary ignition signal

You can select the inner standard probes in the probe settings. After selecting a correct probe, the settings can be seen in the lower right corner of the left column of the channel control button, indicating the probe is in use.

Tap the question mark icon to view the image of the corresponding current clamp in full screen.

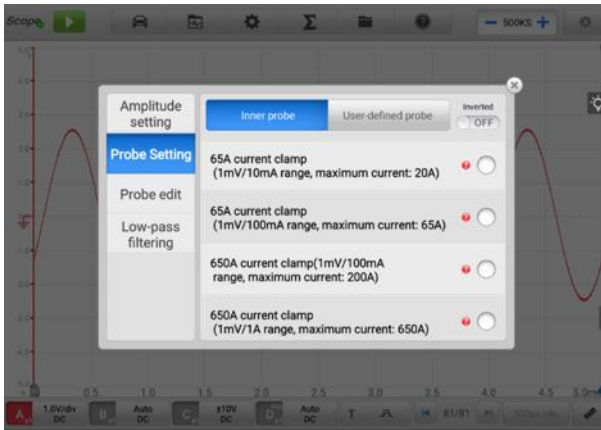


Figure 7-44 Inner Probe Setting Screen

◇ **Probe Edit**

Add custom probes not included in the built-in standard probe menu.

🔍 **NOTE**

Please refer to the probe's instruction manual or consult the corresponding manufacturer for the linear equation ($y=mx+c$).

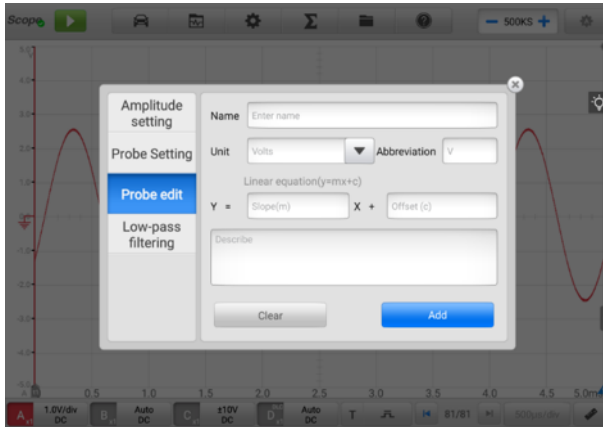


Figure 7-45 Probe Edit Screen

➤ **To add custom probes**

Add a 20 : 1 Attenuator as an example:

1. Tap the right column of the channel control button at the bottom of the screen to open the setting dialog box.
2. Select the **Probe Edit** option in the left column of the dialog box.
3. Tap each field to open the virtual keyboard and input the required information.
4. Tap **Add** to save the settings, or tap **Clear** to exit without saving.
5. The added probe will be listed in the Probe Setting window.

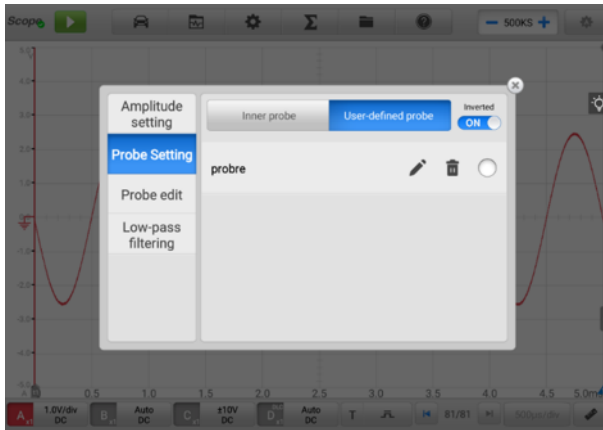


Figure 7-46 Probe Setting Screen (User-defined Probe)

✧ **LPF (Low-pass Filtering)**

The Low-pass Filtering (LPF) is an independent digital low-pass filter for each input channel used to remove noise from the signal.

This function is used to filter the high frequency signal of the selected input channel for more accurate measurements. Take the two screenshots below as an example to show the comparison with or without setting the low-pass filtering. The following screenshots show the difference between waveforms with the low-pass filtering and waveforms without the low-pass filtering.

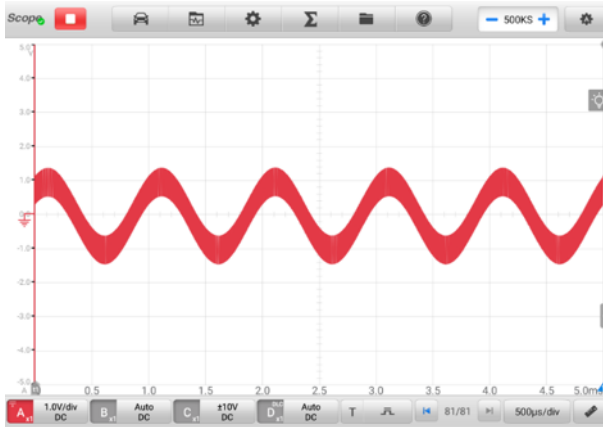


Figure 7-47 Before Setting Low-pass Filtering Screen

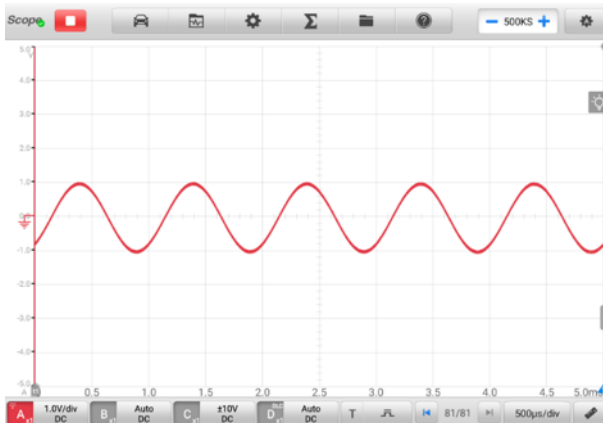


Figure 7-48 After Setting Low-pass Filtering Screen

➤ **To configure the low-pass filtering settings**

1. Tap the right column of the channel control button to open the setting dialog box.
2. Select the **Low-pass Filtering** option from the left column of the dialog box.
3. Tap the checkbox of the appropriate channel and adjust frequency by tapping the minus or plus. The unit can be switched to **Hz**, **KHz** or **MHz** from the dropdown list.



Figure 7-49 Low-pass Filtering Screen

4. Close the dialog box directly to exit without saving.

- **Trigger**

The trigger feature is used to filter and capture specified waveform data.

According to the trigger setting condition, the trigger waveform will be captured when the signal meets the trigger condition. When capturing waveforms, you can manually set the trigger conditions.

When the oscilloscope is capturing the signal, tap the left column of the **Trigger** button to activate the trigger function. A **trigger point** will be shown as a blue point.

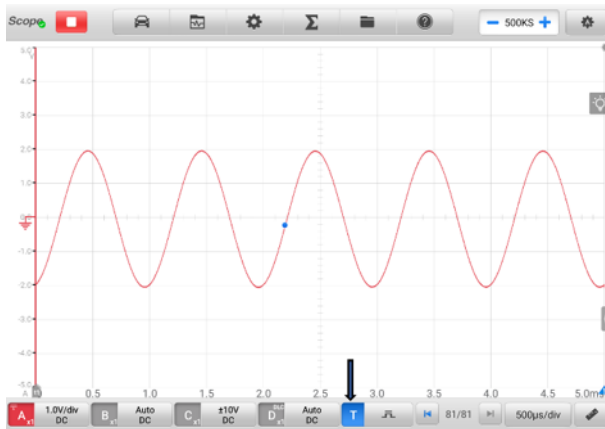



Figure 7-50 Trigger Point Screen

When the oscilloscope is capturing the signal, tap the  icon to open the trigger settings dialog box.

✧ **Edge Triggering**

The edge trigger is one of the most common trigger modes and is activated when voltage rises above or falls below a preset threshold. This trigger type allows you to configure the trigger mode, threshold, trigger channel and pulse direction settings. Tap **OK** to save the settings or tap **Cancel** to exit without saving.

NOTE

The oscilloscope switches to the continuous mode if the time base is set to more than or equal to 200 ms/div. The Edge Triggering is supported in the continuous mode.

- **Trigger Mode**

Four trigger modes are available: **None**, **Auto**, **Repeat**, and **Single**.

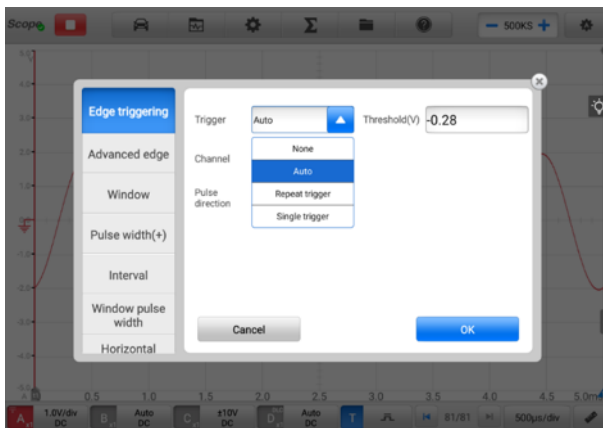


Figure 7-51 Trigger Mode Screen

The table below offers brief descriptions for each trigger mode.

Table 7-7 Trigger Mode Table

Trigger Mode	Description
None	In this trigger mode, the oscilloscope can continuously capture data, without waiting for a trigger event.
Auto	In this trigger mode, the oscilloscope will wait for a trigger before capturing data. It can automatically update after a short period, even if the signal does not across the trigger point.
Repeat	In this trigger mode, the oscilloscope waits until a trigger event occurs. If there is no trigger event, nothing will be displayed on the screen.
Single	In this trigger mode, the oscilloscope stops capturing data once a trigger event occurs.

- **Channel**

Select the applicable trigger channel from the dropdown menu. The selected channel is the one that the oscilloscope monitors for the trigger condition.

- **Pulse Direction**

Two pulse direction settings are available: **Rise** and **Fall**.

Rise Edge Trigger — indicates trigger is turned on to start the trace on the rising edge of the waveform.

Fall Edge Trigger — indicates trigger is turned on to start the trace on the falling edge of the waveform

- **Threshold**

The **Threshold** allows you to set the voltage threshold for the trigger.

- ✓ To precisely position the trigger point, input the value in the Threshold field in the trigger settings dialog box.
- ✓ To roughly position the trigger point, drag the trigger point to a desired position.

➤ **To configure the trigger settings**

1. Tap the right column of the **Trigger** button to open the trigger settings dialog box.
2. Select the trigger mode, trigger channel, and pulse direction in the dropdown list.
3. Input the value in the Threshold field in the trigger settings dialog box.
4. Tap **OK** to save settings or tap **Cancel** to exit without saving.

✧ **Advanced Edge**

This trigger type includes all the functions of the edge trigger type, plus two additional options: **the Rising or Falling option** and **the hysteresis option**.

Rising or Falling option in the dropdown menu of the pulse direction: Dual edges of a waveform can be triggered. This mode is especially useful for monitoring pulses of both polarities at once.

Hysteresis option: It is used to reduce false triggering on noisy signals. When hysteresis is enabled, a second trigger threshold voltage is used in addition to the main trigger threshold. The trigger fires only when the signal crosses the two thresholds in the correct order. The first threshold arms the trigger, and the second causes it to fire.

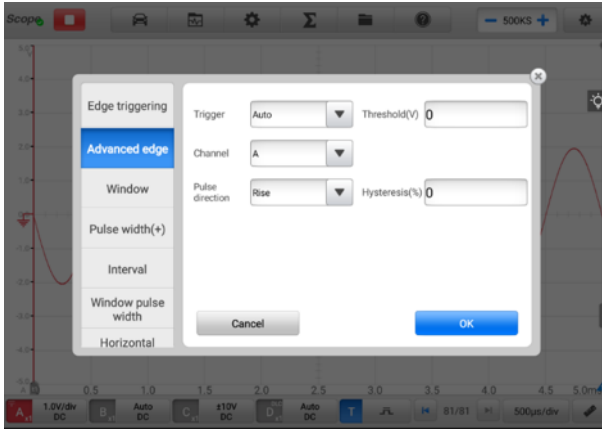


Figure 7-52 Advanced Edge Settings Screen

✧ **Window**

This trigger type is used to monitor when the signal enters or exits a specified voltage window.

Three options are available for the pulse direction: **Entering**, **Exiting**, **Entering or Exiting**. The **Threshold 1** and **Threshold 2** are the upper and lower voltage limits of the window.

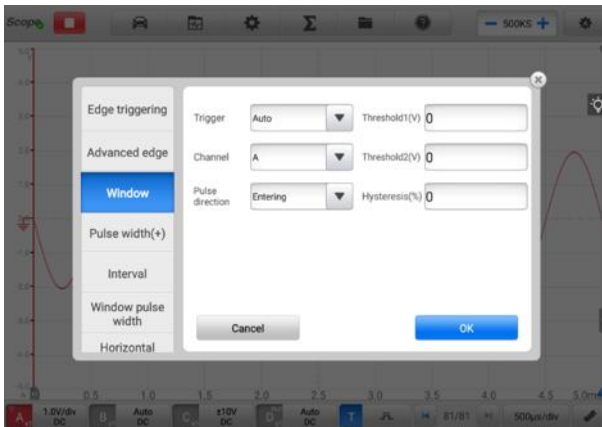


Figure 7-53 Window Settings Screen

❖ Pulse Width (+)

This trigger type allows you to monitor pulses of a specified width.

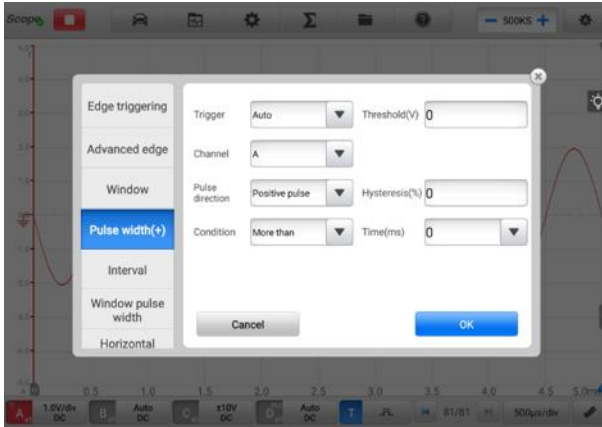


Figure 7-54 Pulse Width Settings Screen

➤ To set the pulse width (+)

1. Tap the **Trigger** button at the bottom of the screen to open the Trigger Settings dialog box.
2. Select the **Pulse Width (+)** in the left column of the dialog box.
3. Select the desired trigger mode and channel mode.
4. Set the pulse direction to either Positive pulse or Negative pulse according to the polarity of the pulse.
5. Select one of the four Conditions:
 - **More than:** triggers on pulses wider than the specified time.
 - **Less than:** triggers on pulses narrower than the specified time.
 - **In the time range:** triggers on pulses wider than Time 1 and narrower than Time 2.
 - **Out of the time range:** triggers on pulses narrower than Time 1 or wider than Time 2.
6. Set the trigger **Threshold** and **Hysteresis**.
7. Set the **Time 1** or **Time 2** in minutes (if available) to define the pulse width.
8. Tap **OK** to save settings or tap **Cancel** to exit without saving.

❖ Interval

This trigger type allows you to search for two consecutive edges of the same polarity separated by a specified time interval.

For the setting operation, please refer to the operation steps of Pulse Width, but the pulse direction with Rise or Fall selection instead of Positive or Negative.

◇ **Window Pulse Width**

This trigger type combines with the window trigger and the pulse width trigger. It detects when a signal enters or exits an input range and stays for a specified period of time. Two **Region** options can be selected: **In range** and **Out of range**.

◇ **Horizontal Distortion**

This trigger type can be monitored when the signal goes high or low for longer than the specified time.

◇ **Window Distortion**

This trigger type monitors when a signal enters a specified voltage range and stays within that range for a specified period of time.

◇ **Underthrow**

This trigger type monitors a pulse that exceeds one threshold and then drops below the threshold without exceeding the second threshold. This type of trigger is typically used to find pulses that do not reach a valid logic level.

● **Buffer**

The buffer is used to store the captured waveform data for real-time and playback display.

The oscilloscope can capture and store waveforms. Select a waveform from the waveform buffer by tapping the **Previous** or **Next** button.

The waveform buffer displays the current waveform number and the total number of stored waveforms.

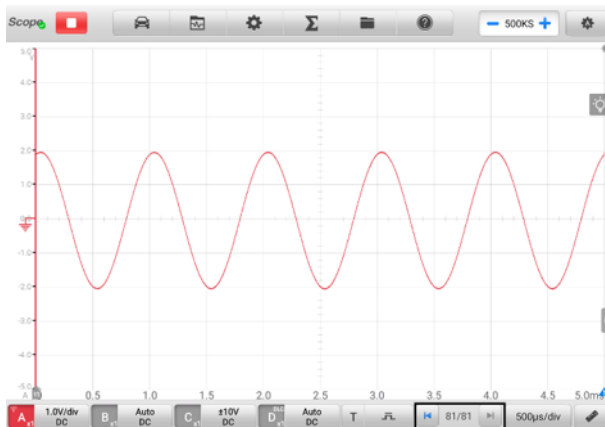


Figure 7-55 Buffer Screen

Button	Name	Description
	Previous	Tap to display the previous waveform in the buffer.
	Buffer Index	Displays the number of the waveform currently displayed onscreen out of the total number of buffered waveforms.
	Next	Tap to display the next waveform in the buffer.

- **Time Base**

The Time Base controls the oscilloscope data sampling display time. Tap the **Time Base** button at the bottom to open the setting dialog box.

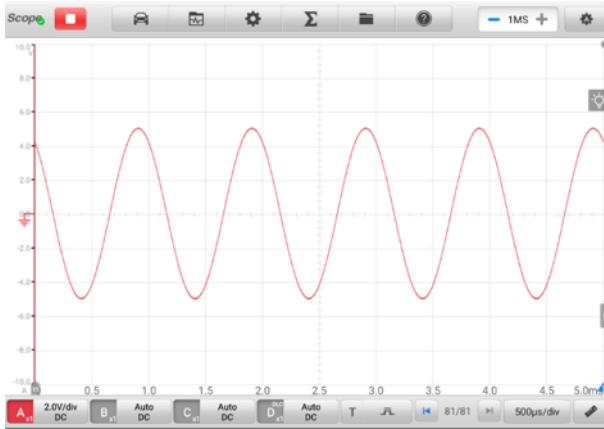


Figure 7-56 Time Base Screen 1 (Normal Mode)

Continuous Mode: if the time base is set to more than or equal to 200ms/div, the oscilloscope switches to the continuous mode. In this mode, the oscilloscope updates the trace continuously as each capture progresses, rather than waiting for a complete capture before updating the trace.

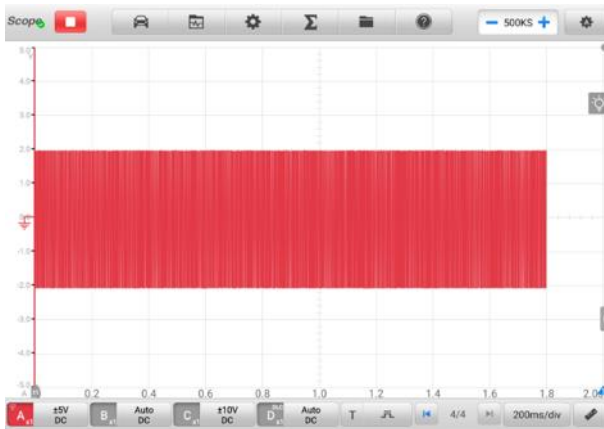


Figure 7-57 Time Base Screen 2 (Continuous Mode)

- **Measurement**

The available measurements for each channel are (from left to right):



Figure 7-58 Measurement Screen 1

- ❖ **Maximum** — the highest level that the signal reaches
- ❖ **Minimum** — the lowest level that the signal reaches
- ❖ **Peak To Peak** — the difference between maximum and minimum
- ❖ **Amplitude** — the top value minus the bottom value
- ❖ **Period** — the duration of one cycle in a repeated pattern in the waveform
- ❖ **Frequency** — the number of signal occurrences per second
- ❖ **Positive Duty Ratio** — the ratio of positive pulse width to period width
- ❖ **Negative Duty Ratio** — the ratio of negative pulse width to period width
- ❖ **Positive Pulse Width** — the amount of time that the signal spends above its average value
- ❖ **Negative Pulse Width** — the amount of time that the signal spends below its average value
- ❖ **AC RMS** — the root mean square (RMS) value of the waveform minus the DC Average
- ❖ **True RMS** — the root mean square (RMS) value of the waveform, including the DC component
- ❖ **DC Average** — the average value of the waveform
- ❖ **Rising Rate** — the rate at which the signal level rises

- ✧ **Falling Rate** — the rate at which the signal level falls
- ✧ **Rise Time** — the time the signal takes to rise from the lower threshold to the upper threshold
- ✧ **Fall Time** — the time the signal takes to fall from the upper threshold to the lower threshold
- ✧ **X@Max** — the corresponding value of X axis when the amplitude is the maximum
- ✧ **X@Min** — the corresponding value of X axis when the amplitude is the minimum
- ✧ **Positive Acreage** — the waveform acreage measured above the zero baseline
- ✧ **Negative Acreage** — the waveform acreage measured below the zero baseline
- ✧ **Full Acreage** — the positive acreage plus negative acreage
- ✧ **Top Value** — 90% of the waveform maximum value
- ✧ **Bottom Value** — 10% of the waveform minimum value
- ✧ **Positive Overshoot** — the ratio of the difference between the maximum value and the top value and the amplitude
- ✧ **Negative Overshoot** — the ratio of the difference between the bottom value and the minimum value and the amplitude
- ✧ **Positive Pre-shoot** — the ratio of the difference between the bottom value and the minimum value and the amplitude
- ✧ **Negative Pre-shoot** — the ratio of the difference between the maximum value and the top value and the amplitude

 **NOTE**

When connecting via Wi-Fi, it only supports Maximum, Minimum, Peak To Peak, Amplitude, Period, Frequency, Positive Duty Ratio, Negative Duty Ratio, Positive Pulse Width, Negative Pulse Width, AC RMS, True RMS, DC Average, X@Max, X@Min, Top Value and Bottom Value.

In the **Spectrum View**, the available measurements are as follows.

- ✓ **Frequency Peak Value** — the frequency of the peak signal value
- ✓ **Amplitude Peak Value** — the amplitude of the peak signal value
- ✓ **Average Amplitude Peak Value** — the amplitude of the peak signal value captured over multiple times
- ✓ **Total Power** — the power of the entire signal captured in the spectrum view
- ✓ **Total Harmonic Distortion Percentage (THD)** — the ratio of the sum of harmonic powers to the power of fundamental frequency

$$\text{THD} = \frac{\sqrt{V_1^2 + V_2^2 + V_3^2 + V_4^2 + V_5^2}}{V_f}$$

- ✓ **Total Harmonic Distortion (THD) dB:** the ratio of the sum of harmonic powers to the power of fundamental frequency

$$\text{THD} = 10\log_{10} \left(\frac{\sqrt{V_1^2 + V_2^2 + V_3^2 + V_4^2 + V_5^2}}{V_f} \right)$$

- ✓ **Total Harmonic Distortion and Noise (THD + N)** — the ratio of the harmonic power plus noise to the fundamental power

$$\text{THD} + \text{N} = 10\log_{10} \left(\frac{\text{THD} + \text{N}}{V_f} \right)$$

- ✓ **Spurious-free Dynamic Range (SFDR)** - the ratio of the amplitude of the highest peak in the spectrum to that of the second highest peak
- ✓ **SINAD** — signal to noise and distortion ratio. The ratio (in decibels) of the signal-plus-noise-plus-distortion to noise-plus-distortion

$$\text{SINAD} = 10\log_{10} \left(\frac{\text{Signal}}{\text{Noise} + \text{noise}} \right)$$

- ✓ **Signal Noise Ratio (SNR)** — the ratio (in decibels) of average signal power to average noise power

$$\text{SINAD} = 10\log_{10} \left(\frac{\text{Signal}}{\text{Noise}} \right)$$

- ✓ **Inter-modulation Distortion (IMD)** — a measure of distortion due to non-linear mixing of two tones

$$\text{IMD} = \sqrt{\frac{F_3^2 + F_4^2}{F_1^2 + F_2^2}}$$

➤ **To set the measurement**

1. Tap the **Measurement** button at the bottom of the screen to open the measurement dialog box.
2. Select the channel to be measured.

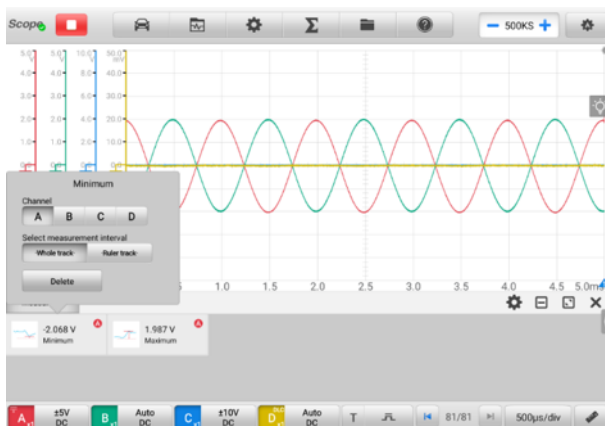


Figure 7-59 Measurement Setting Screen

3. Close the dialog box, and the corresponding measurement readings are displayed on the lower side of the screen. The Whole Track and Ruler Track can be toggled by tapping the reading. Adjust the whole track or ruler track on the displayed screen, or tap **Delete** to delete the measurement.

➤ **To set the measurements in Spectrum View**

1. Tap the **Settings** button in the upper toolbar. A dialog box opens. Select the **Mode** option in the dialog box, and then tap to select **Spectrum View**.
2. Tap the **Measurement** button at the bottom of the screen to open the measurement dialog box.
3. Select the channel to be measured.
4. Select the appropriate measurement options.

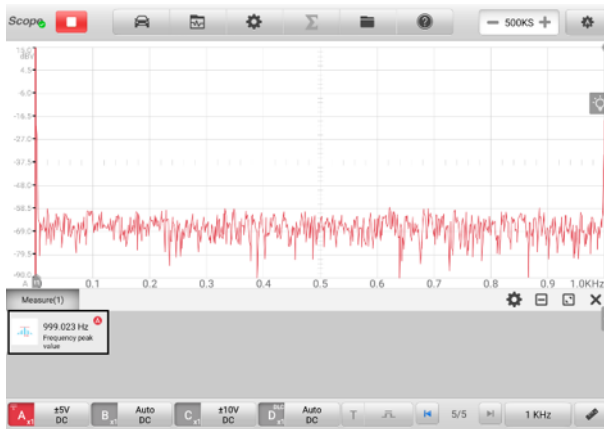


Figure 7-60 Measurement Setting Screen (Spectrum View)

5. Close the dialog box, and the corresponding measurement readings are displayed on the lower side of the screen. Tap **Delete** to delete the measurement.

7.1.6 Troubleshooting

- A. If the oscilloscope cannot communicate with the MaxiSys tablet:
 - Ensure the VCMI device is properly connected to the MaxiSys tablet via BT, Wi-Fi or with the supplied USB cable.
 - Restart the MaxiSys tablet and reconnect the VCMI device if communication between the two continues to fail.
- B. If unwanted signals are displayed or signals are distorted:
 - Use only the supplied test leads or probes to connect with the input channels.
 - Check the test leads or probes for damage.
 - Ensure the polarity of the test leads connections are correct.
 - Ensure the signal and ground connections are clean and secure.
 - Ensure the ground lead is providing a direct ground from the circuit to the input channel.
 - Isolate the test leads from other components, leads, or systems that may induct unwanted noise into the signal being tested including the electric motors, secondary ignition components, relays, alternators.

7.1.7 Glossary

AC/DC Control

Each channel can be set to either AC coupling or DC coupling. With DC coupling, the voltage displayed onscreen is equal to the true voltage of the signal with respect to ground. With AC coupling, any DC component of the signal is filtered out, leaving only the variations in the signal for the AC component.

Aliasing

When the signal frequency gets higher than half the scope's maximum sampling rate and exceeds the limit, a distorted waveform displays. This distortion is called aliasing.

Amplitude

The maximum voltage generated from the zero volts line of the oscilloscope.

Analog Bandwidth

The frequency at which a displayed sine wave has half the power of the input sine wave (about 71% of the amplitude).

Buffer Size/Cache Size

The size of the oscilloscope's buffer memory. The buffer memory is used by the oscilloscope to temporarily store data. This helps to compensate for the differences in data transfer rate from one device to another.

Frequency

The number of signal occurrences per second. Frequency is measured in Hz (hertz).

Peak to peak voltage

The difference in voltage between the minimum and maximum voltages occurring in the waveform.

Time Base

The time interval across the scope display.

Voltage Range

The range between the maximum and minimum voltages that can be accurately captured by the oscilloscope.

Sampling Rate

The number of samples per second captured by the oscilloscope. The faster the sampling rate of the scope, the more frequently it measures the signal voltage, and so the more detailed will be the trace that appears on the scope screen.

7.2 Multimeter

The multimeter is a multi-function and multi-range measuring instrument. When the VCMI (Vehicle Communication and Measurement Interface) device is connected with MaxiSys tablet, you can open the **Multimeter** application by tapping the Measurement icon on the Job Menu of the tablet and then tapping the Multimeter icon, and perform the multimeter-related functions, such as measuring voltage, current, resistance, frequency, diode, duty cycle, pulse width, and continuity test.

7.2.1 Safety Information

Follow the instructions below to reduce the risk of injury from electric shock and prevent equipment damage.

- Use the multimeter only as specified in this manual.
- Do not apply more than the rated voltage between connectors or between any connector and earth ground.
- Do not input a value beyond the range when measuring. Remember that the limit value range of this multimeter is 200 V.
- To prevent injury or death, do not use the multimeter if it appears to be damaged in any way, and stop use immediately if you are concerned with any abnormal operations.
- To prevent injury or death, never ground yourself when taking electrical measurements. Isolate yourself from ground by using dry rubber insulating mats to cover all exposed/grounded metal. Ensure all clothing including gloves are dry. Stand on rubber mats when using tool.
- Use the test leads or probes supplied with the product, or proper and applicable terminals. Inspect the test leads or probes for damage before use.
- When using probes, keep fingers behind the finger guards on the probes.
- Use the supplied replacement fuses or specified replacement parts.
- Always consider electrical and electronic equipment to be energized (live). Never assume any equipment is de-energized.
- When making electrical connections, connect the common test lead before connecting the live test lead; when disconnecting, disconnect the live test lead

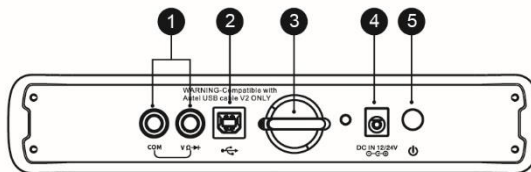
before disconnecting the common test lead.

- When measuring current, turn off circuit power before connecting the multimeter to the circuit. Remember to place the multimeter in series with the circuit.
- After current measurement is finished, turn off the power to the circuit before removing the test leads and before reconnecting any disconnected wires or devices.
- Do not add voltage to the input terminal when measuring resistance.
- To avoid electric shock, turn off the power to the component before connecting.
- To prevent damage, always use and store your multimeter in appropriate environments.
- Do not use in wet or damp conditions, or around explosive gas or vapor.
- Do not tamper with or disassemble the multimeter, connectors or accessories. Internal damage will affect performance.
- Before carrying out maintenance and cleaning of the multimeter, make sure the unit is NOT connected to a power source, vehicle or computer.
- When cleaning the multimeter, use a damp, soft cloth with mild detergent. Do not allow water to enter the multimeter casing.

7.2.2 General Introduction

7.2.2.1 Component Locations

The multimeter jacks are located on the top of the VCMI device while the input channels are located at the bottom.

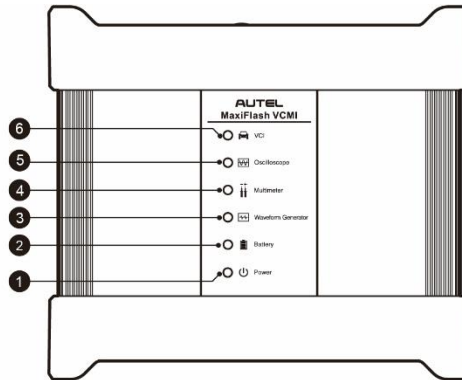


1. Multimeter Jacks — for ground and signal cables
2. USB Port
3. Hook
4. DC Power Supply Input Port
5. Power Button

! IMPORTANT

When using the multimeter function, please insert the supplied multimeter probes to the multimeter probe jacks. When measuring the current, use a current clamp to connect to the input channel A on the top of the VCMI device.

The multimeter LED is located on the front panel of the VCMI device. When the VCMI is properly connected and powered on, the multimeter LED lights green when operating in the multimeter mode.



1. Power LED
2. Battery LED
3. Waveform Generator LED
4. Multimeter LED
5. Oscilloscope LED
6. Vehicle LED



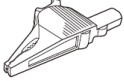
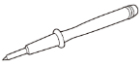


7.2.2.2 Technical Specifications


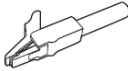


Table 7-8 Technical Specifications

Item	Description
Voltage Range	VDC 200 V VAC 200 V _{RMS}
Resistance Range	1 Ω to 10 MΩ
Diode	2 V
Frequency Range	1 Hz to 1 MHz
Duty Cycle Range	1% to 99 %
Pulse Width Range	1 us to 1000 ms
Current Range	0 to 65 A (65 A current clamp)

7.2.2.3 Accessories

The following accessories are compatible with the multimeter and oscilloscope.

		
65 A current clamp	650 A current clamp	Large Dolphin Clip
		
Multimeter Probe	Back-pinning Probe	Flexible Back-pinning Probe

 <p>Battery Clip</p>	 <p>Small Crocodile Clip</p>	 <p>Breakout Lead</p>
 <p>Multimeter Test Lead: used to connect the multimeter and multimeter probe.</p> <p>NOTE: The two multimeter test leads (Red: SA015 / Black: SA016) are standard for the multimeter and waveform generator.</p>		

7.2.3 Getting Started

Before opening the Multimeter application, ensure the VCMI device is connected to the tablet via Wi-Fi or with the supplied USB cable.

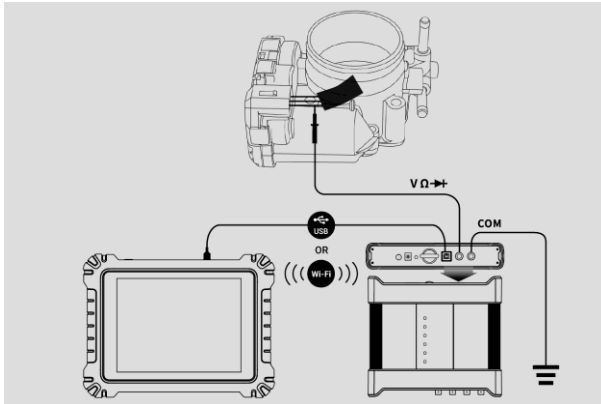


Figure 7-61 Connection Diagram

➤ **To open the multimeter application**

1. Insert the applicable test leads or probe terminal ends into the multimeter jacks to complete the connection.
2. Tap the **Measurement** icon on the MaxiSys Job Menu. The Measurement screen opens.
3. Tap the **Multimeter** icon to open the Multimeter Menu.

4. Select a test to continue.

NOTE

Please check the multimeter LED status indicator on the front panel of VCMI device. The multimeter LED lights green when operating in the multimeter mode.

7.2.4 Multimeter Update

The operating software of the multimeter is continually optimized. Tap the **Help** button in the upper toolbar and then tap the **Update the APK** button in the dropdown list to update the software.

Before update the multimeter's software, please ensure the tablet has a stable Internet connection.

7.2.4.1 APK Update

NOTE

The acronym APK (Android Package Kit) is used on the tablet and in this manual. This file contains all the assets of a particular app. To update the APK, is to install the latest version of the app on your tablet.

➤ **To update the APK**

1. Tap the **Help** button on the upper half of the screen. A dropdown menu displays.



Figure 7-62 Help Screen

2. Tap the **Update the APK** in the dropdown menu. If the current APK is not the latest version, a confirmation message will appear: An APK update is available. Do you want to update? Restart the App after update.
3. Tap **OK** to update the software or tap **Cancel** to exit.

7.2.5 Screen Layout and Operations

Tap the **Measurement** icon on the Job Menu, then tap the **Multimeter** icon in the menu, the multimeter page displays. The screen typically includes the following button sections.

NOTE

The Multimeter application can also be opened via the Android home screen. Tap the **Measurement** icon at the top of the Android home screen. Tap **Multimeter**.

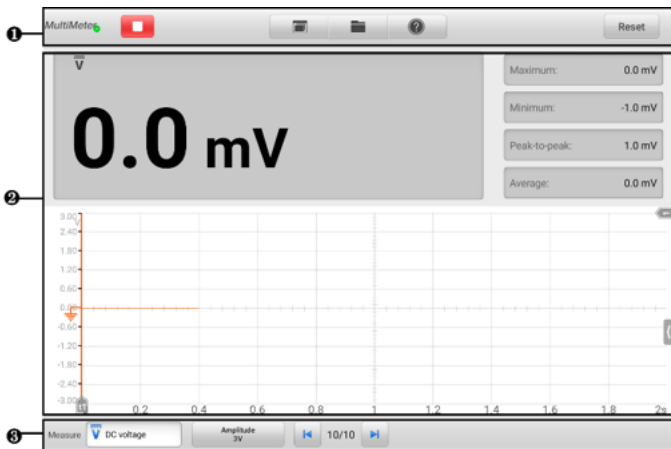


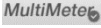





Figure 7-63 Multimeter Menu Screen

1. Upper Toolbar
2. Main Section
3. Lower Toolbar

7.2.5.1 Upper Toolbar

The upper toolbar is used for configurations of various settings and operations. The following table provides brief descriptions of each button.

Table 7-9 Upper Toolbar



Button	Name	Description
	Multimeter Icon	Displays the multimeter connection status.
	Start/Stop Button	Start or stop the multimeter device.
	Show Mode	Set the display mode.
	File	Print, open and save the waveform data.
	Help	View the user manual, and update the APK.
	Reset	Reset the digital readouts displayed in the figure mode.

- **Multimeter Icon**

This **Multimeter status button** displays the multimeter connection status. A **green** check mark means the tablet and the Multimeter are connected; a **red X** means the device and the tablet are not connected.

- **Start/Stop Button**

Press this **Start/Stop Button** icon to start and stop the multimeter device.

Name	Button	Description
Start		Tap to start the multimeter.
Stop		Tap to stop the multimeter.

- **Show Mode Menu**

The position of the digital readouts and waveform in the main view section can be selected in the Show Mode Menu.

➤ **To set the show mode**

1. Tap the **Show Mode** button in the upper toolbar. A submenu opens.

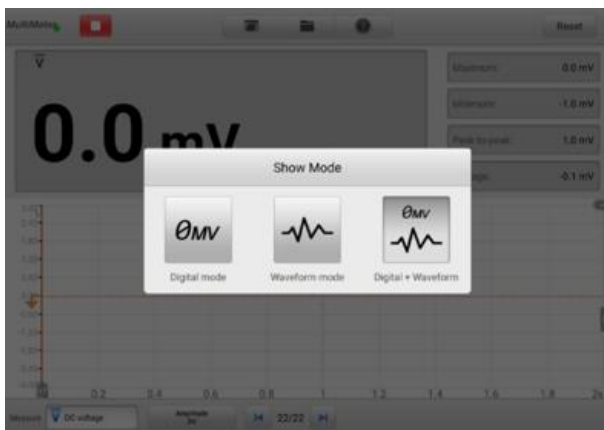


Figure 7-64 Show Mode Menu Screen

2. Select one of the three display modes.
3. The corresponding display mode will be shown on the screen.

Icon	Mode	Description
	Digital Mode	Displays the digital readouts only.
	Waveform Mode	Displays the waveform only.
	Digital + Waveform Mode	Displays both the digital readouts and waveform.

● **File Menu**

The File Menu supports the following functions.



Figure 7-65 File Menu Screen

- ✓ **Print** — tap to create and print a temporary PNG picture of the current waveforms.

NOTE

Ensure the tablet is configure to print (see Printer setup instructions) and is connected to the printer. Ensure the tablet and printer share the same network.

- ✓ **Waveform File Operation**

Save and open the waveform files in this section. Only **Waveform** mode and **Digital + Waveform** mode support this operation.

Save Waveform — Tap to capture and save the current waveforms. On the Save File screen, tap each item to input the corresponding information and then tap **Save** or **Save Default** to finish.

NOTE

The file name is required when saving waveforms.

Open Waveform — tap to retrieve the saved waveforms. Tap the **Edit** button in the upper right corner of the screen to select and delete the saved waveform.

Save as text — tap to save the current waveform data to a text file. Use the ES File Explorer app on the Android home screen to review file: **Home > ES File Explorer > Local > Internal Storage > Scan > Data > Multimeter > txt.**

✓ **Configuration Operation**

The configurations can be saved and imported.

Save the Configuration — tap to save the configuration settings (i.e., the amplitude, the time base) of waveforms on the current screen.

Import the Configuration — tap to import the saved configuration settings for waveforms.

● **Help Menu**

The Help Menu allows you to view the user manual, update the software, and view versions of the device.

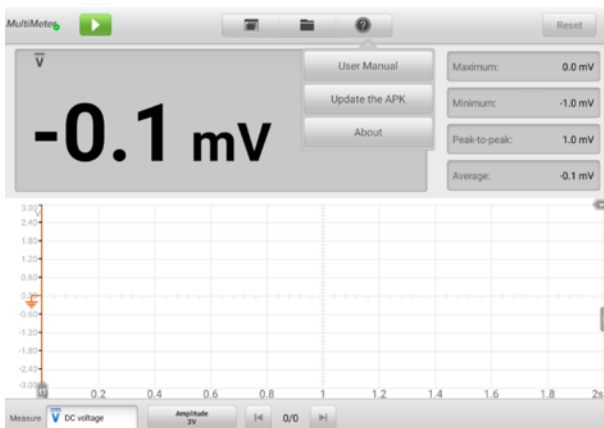


Figure 7-66 Help Menu Screen

User Manual — displays instruction for the proper use of the multimeter.

Update the APK — connects to the Autel server to get the latest application software version.

About — displays the model number and version numbers of the installed software.

7.2.5.2 Main Section

The main view section displays differently depending on the selected mode.

- **Digital Mode**

The main view section in the digital mode displays only the digital readouts such as values of voltage measurement, maximum measurement, minimum measurement, peak to peak measurement and average measurement.

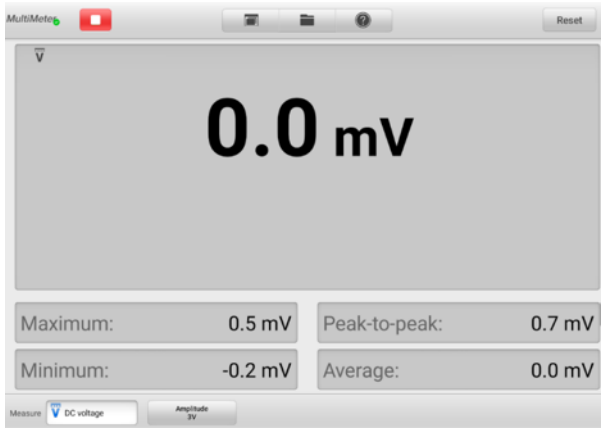


Figure 7-67 Main Section Screen (Digital Mode)

- ◇ **Current Value:** the current value can be the AC voltage, DC voltage, resistance, frequency, or duty cycle
 - ◇ **Maximum:** the recorded maximum value of the measurement
 - ◇ **Minimum:** the recorded minimum value of the measurement
 - ◇ **Peak to Peak:** the difference between the maximum and minimum values
 - ◇ **Average:** the average value of the measurements
- **Waveform Mode**

The main section in the scope mode only displays the waveform.

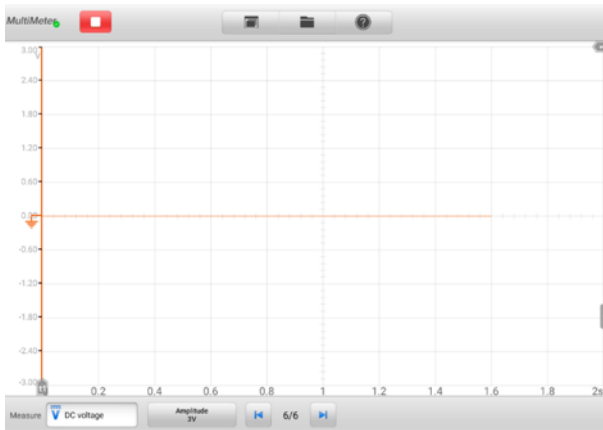


Figure 7-68 Main Section Screen (Waveform Mode)

The main section features a coordinate grid with the **X-axis** representing the time duration and the **Y-axis** representing the amplitude level. The amplitude level on the Y-axis can be configured in the Amplitude Settings.

A. Channel Selection

In the main section, a channel has two conditions: selected and unselected. A channel must be selected in order for the waveform to be movement, to use the zoom-in or to add measurement rulers.

➤ To select and unselect the channel

1. Tap the Zero Baseline marker or the Y-axis (the line thickens when selected).
2. Tap the Zero Baseline marker or the Y-axis again to exit the channel selection.

B. Waveform Zooming

The zooming function allows you to change the size and position of a signal during or after capturing a waveform to examine it in greater details. It does not change the stored data, but the way it displays.

The X-axis and Y-axis can be zoomed using your fingertips. The waveform can be zoomed during or after capturing the signal.

C. Measurement Rulers

In the coordinate grid, there are two kinds of **measurement rulers**, which allow the amplitude and time duration of a waveform to be measured precisely. They are useful when determining signal characteristics such as amplitude at specific

points, the cycle time (duration) and frequency.

The vertical **Time Ruler** — tap the **Ruler Activator** in the bottom left corner of the grid and drag it across the screen to the desired position. A **Time Ruler** is generated.

The horizontal **Signal Ruler** — the **Signal Ruler** can be generated in the similar way by tapping the **Ruler Activator** in the upper right corner and dragging it downwards.

NOTE

The horizontal signal ruler varies according to the settings of the voltage, current, frequency, duty cycle, etc.

When dragging the Measurement Rulers, a **Ruler Table** showing time and amplitude values for the corresponding channels will be displayed. The **Delta** icon refers to the absolute difference between the values of the rulers, which can be locked by tapping the **Lock** icon. Tap the **X** button in the upper right corner of the ruler table to delete all rulers.

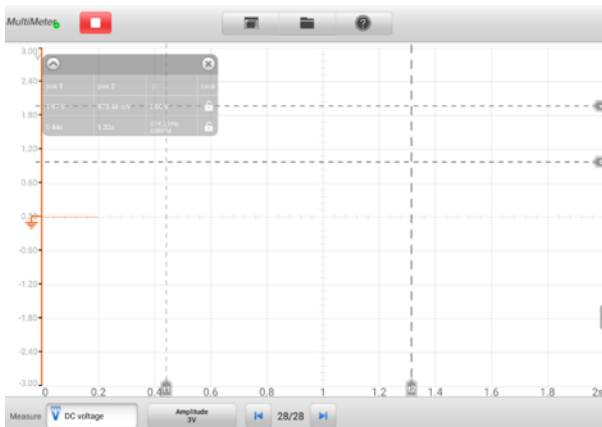


Figure 7-69 Measurement Rulers Screen

D. Zero Baseline

The zero baseline is marked the 0 value in the Y-axis, showing the ground level of each channel waveform. After the channel is selected, the zero baseline can be adjusted by dragging the baseline marker up/down along the Y-axis, or dragging the waveform up/down or moving the screen up/down in the grid.

NOTE

Tap the baseline marker to make the vertical scale line thicker. In this case, the channel is selected. Tap the baseline marker again to unselect and the waveform cannot be dragged.

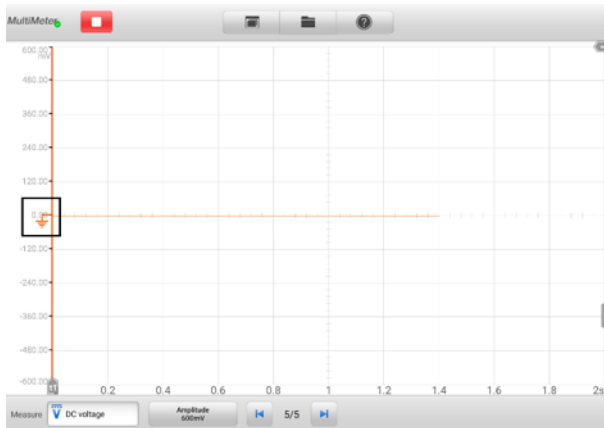


Figure 7-70 Zero Baseline Screen

E. Wiring Diagram and Help

Tap the arrow button in the lower-right corner of the screen to open the Wiring Diagram and Help window.

The **Wiring Diagram** function provides the connection diagram, operation steps and operation notes.

The **Help** function provides the user manual, displaying information relevant to the procedure, operation or instructions.

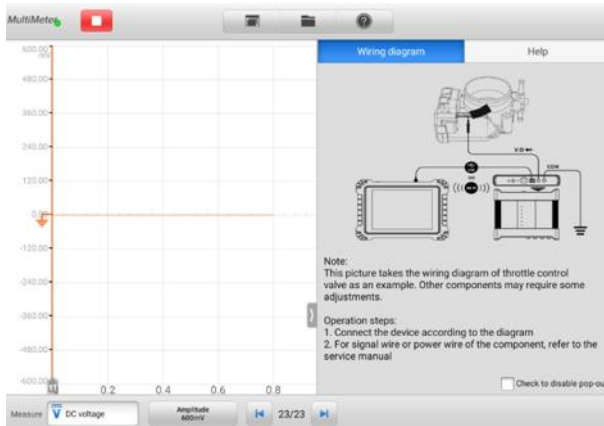


Figure 7-71 Wiring Diagram and Help Screen

- **To open and close the Wiring Diagram and Help window**
 1. Tap the arrow button on the right-hand side of the screen.

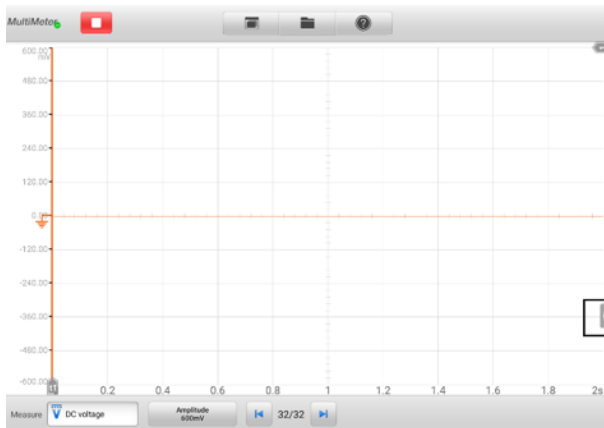


Figure 7-72 Arrow Button Position Screen

2. The **Wiring Diagram and Help** window displays.
3. Tap the arrow button again or tap any space outside of the window.

- **Digital + Waveform Mode**

In this mode, the main section displays the digital readouts on the top and the waveform in the grid.

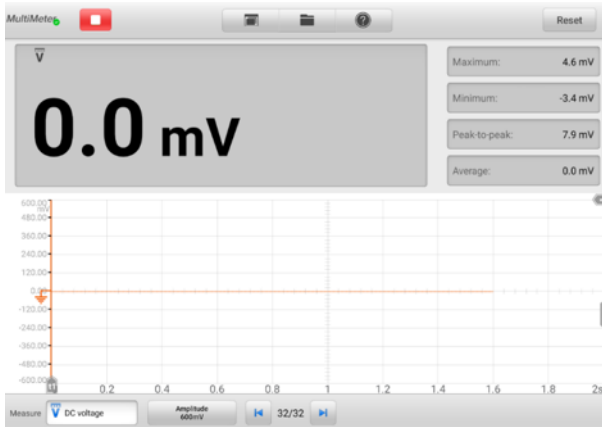


Figure 7-73 Main Section Screen (Digital + Waveform Mode)

7.2.5.3 Lower Toolbar

The measurement, buffer and amplitude can be configured in the lower toolbar.

Table 7-10 Lower Toolbar

Button	Name	Description
Measure <input type="button" value="V AC voltage"/>	Measurement	Tap to select an appropriate measurement.
Amplitude <input type="button" value="1V"/>	Amplitude	Tap to select an appropriate amplitude value.
<input type="button" value="⏪"/> 32/32 <input type="button" value="⏩"/>	Buffer	Tap the Previous or Next button to switch to the previous or the next waveform.

- **Measurement Setting**

This multimeter can be used to measure AC voltage, DC voltage, resistance, AC electricity, DC electricity, diode, frequency, duty cycle, pulse width, continuity and period.

The measurement types include:

- ✧ **AC/DC voltage:** measures the voltage in the electrical circuit
- ✧ **Resistance:** measures the resistance of the electrical circuit or the component
- ✧ **AC/DC current:** measures current amperage through the input channel A by using the optional current clamp

 **NOTE**

The type of current clamp can be selected in the dropdown list.

- ✧ **Diode:** conducts the diode test of the electrical circuit
- ✧ **Frequency:** measures the frequency of the input signal
- ✧ **Duty Cycle (+)/(-):** measures the (+) and (-) duty of the input signal
- ✧ **Connectivity:** determines whether a low impedance exists two points in the electrical circuit. If the impedance is less than 100 ohms, the circuit is "closed", otherwise, the circuit is "open".
- ✧ **Period:** measures the amount the time that one complete cycle of the input signal endures
- ✧ **Pulse Width (+)/(-):** measures the pulse width of the input signal

➤ **To set the measurement setting**

1. Tap the **Measurement Setting** button in the lower-left corner of the screen. A dialog box appears.

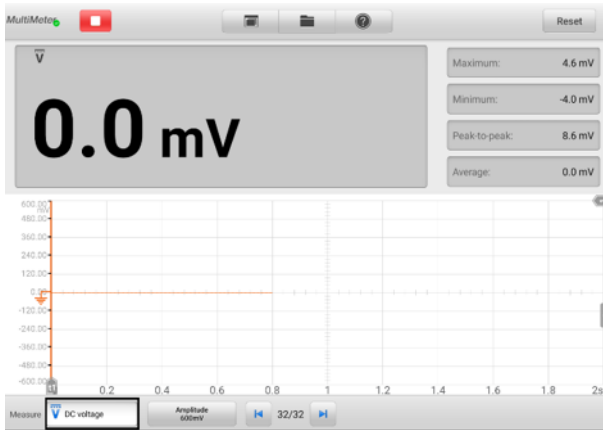


Figure 7-74 Measurement Setting Position Screen

2. Select the **measurement type** you want to measure or test in the right column of the dialog box. The blue color indicates the option is selected.

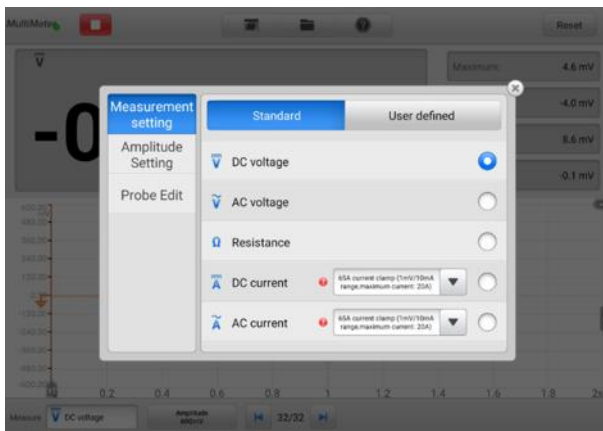


Figure 7-75 Measurement Setting Screen

3. Close the dialog box, the measurement type you set displays on the screen.

- **Amplitude Setting**

Amplitude value can be configured for the selected measurement type excluding resistance measurement.

The amplitude settings allow you to set up the multimeter to capture signals within the specified range. If the input signal exceeds the selected range, an over-range indicator will be displayed. Select **Auto** to enable the device to adjust the vertical scale automatically.

There are two modes available to set the amplitude value.

Mode 1: For example, selecting **DC voltage** in Measurement setting screen sets the measurement type to DC voltage, selecting **10 V** in Amplitude setting screen sets the amplitude to Amplitude 10 V (displays on the lower left corner of the screen). The vertical scale range is from -10 V to +10 V. As the vertical scale is divided into 10 segments, each segment increases by 2 V.



Figure 7-76 Amplitude Setting Screen (DC 10 V)

Mode 2: Select the **## /div** button to adjust the value increments of each division. For example, selecting **DC voltage** in Measurement setting screen, sets the measurement type to DC voltage. Selecting **2.0 V/div** in Amplitude setting screen, sets the amplitude to Amplitude 2.0 V/div (displays on the lower left corner of the screen). Each segment increases by 2 V. As the vertical scale is divided into 10 segments, the entire vertical scale range is from -10 V to +10 V.



Figure 7-77 Amplitude Setting Screen (DC 2.0 V/div)

- **Testing Procedures**

The following section describes how to use the multimeter. The testing procedures are the same for each measurement type.

The following directions are for measuring AC voltage.

- **To measure AC voltage**

1. Tap the **Measurement Setting** button in the lower-left corner of the screen to open the setting dialog box. Select **AC voltage** in the dialog box.
2. Set the proper amplitude value in the **Amplitude Setting** menu in the same dialog box.
3. Connect the supplied multimeter test lead to the VCOM multimeter jacks. Insert the multimeter probe into the test lead.
4. Hold the probes to the correct points of the circuit.
5. Tap the **Start** button on the upper-left corner of the screen to start the multimeter. The voltage displays onscreen.

NOTE

Use the optional current clamp connected to the input channel A when measuring currents. Use the supplied multimeter probes to connect with the multimeter jacks for other measurement types.

- **Probe Edit**

Use the probe edit menu to add the not included probes into the probe menu.

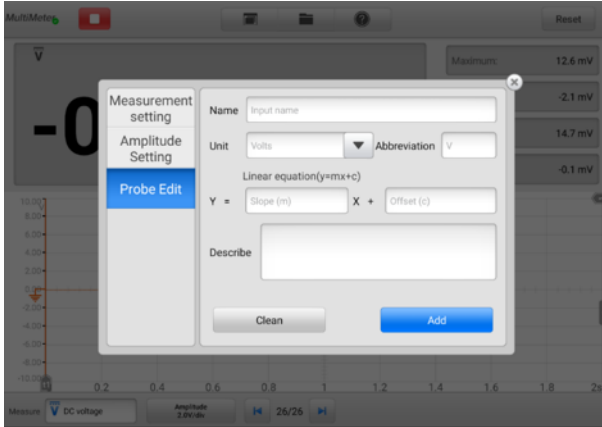


Figure 7-78 Probe Edit Screen 1

➤ **To add custom probes**

1. Tap the **Measurement Setting** button in the lower left corner of the screen to open the setting dialog box.
2. Select the **Probe Edit** option in the left column of the dialog box.
3. Tap each field to open the virtual keyboard and input the required information.

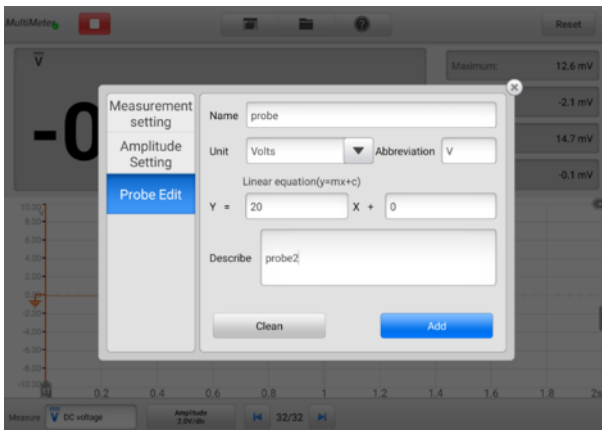


Figure 7-79 Probe Edit Screen 2

4. Tap **Add** to save the settings, or tap **Clean** to exit without saving.
5. The added probe will be listed in the Measurement Settings window. Tap the “**X**” button in the upper-right corner to close the dialog box.
6. After selecting the custom probe, connect a matching probe in the input channel A. The probe is connected to the signal position to be measured for measurement. At this time, the current measurement is displayed on the screen.

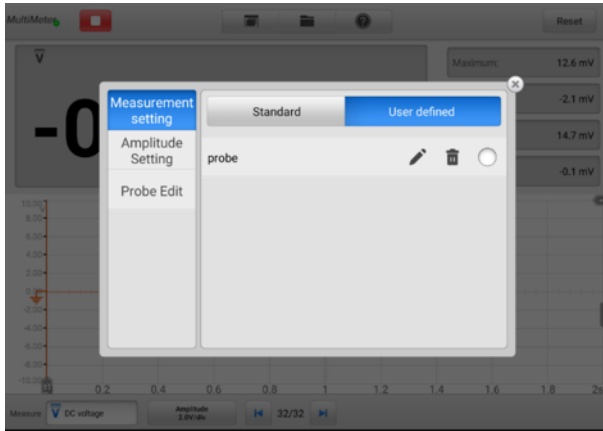


Figure 7-80 Probe Edit Screen 3

- **Buffer**

The waveform buffer displays the current waveform number and the total number of stored waveforms.

The multimeter can capture and store up to 32 waveforms. Tap the **Previous** or **Next** button to review waveforms.

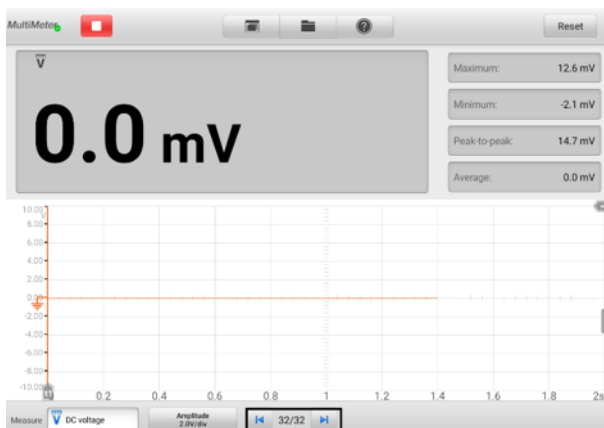





Figure 7-81 Buffer Screen

Button	Name	Description
	Previous	Tap to display the previous waveform in the buffer.
	Buffer Index	Displays the number of the waveform currently displayed onscreen out of the total number of buffered waveforms.
	Next	Tap to display the next waveform in the buffer.

7.2.6 Troubleshooting

If the multimeter cannot communicate with the tablet:

- Check if the VCMI device is properly connected to the tablet via Wi-Fi or the supplied USB cable.
- If the communication between the VCMI device and the tablet still fails, restart the tablet and reconnect the VCMI device.

7.2.7 Glossary

AC

Alternating Current — electrical current that switches polarity at regular intervals.

DC

Direct Current — electrical current that flows in one direction only.

Amperage

The strength of an electric current, expressed in amperes.

Amplitude

The maximum voltage generated from the zero volts line of the multimeter.

Frequency

The number of signal occurrences per second. Frequency is measured in Hz (hertz).

Duty Cycle

The length of a signals on time. Specified as a percentage (ratio), of the total cycle time.

Peak to Peak

The difference between maximum and minimum value.

Diode

Diode is an electronic device made of semiconductor materials, with a single conductivity.

Grid

A network of horizontal and vertical scales displayed on the screen that aids in the measuring of signal characteristics. **Waveform Generator**

The signal generator is an instrument that simulates the signals of automotive electronic components. When the VCMI (Vehicle Communication and Measurement Interface) device is connected with MaxiSys tablet, you can open the **Waveform Generator** application by tapping the Measurement icon on the Home screen of the tablet and then tapping the waveform generator icon, and perform the waveform generator-related functions, including simulating automotive sensor signals and actuator signals.

7.2.8 Safety Information

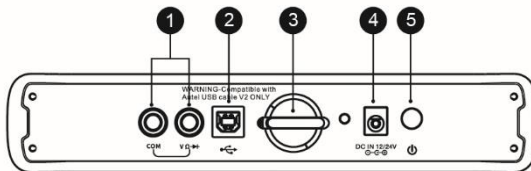
Follow the instructions below to reduce the risk of injury from electric shock and prevent equipment damage.

- Use the waveform generator only as specified in this manual.
- Do not apply more than the rated voltage between connectors or between any connector and earth ground.
- To minimize shock hazard, please connect the device ground input (chassis) to an electrical ground.
- Do not alter the ground connection. Without the protective ground connection, all accessible conductive parts can render an electric shock.
- To avoid electric shock hazard, disconnect power cable before removing covers.
- To prevent injury or death, do not use the waveform generator if it appears to be damaged in any way, and stop use immediately if you are concerned any abnormal operations.
- Inspect the test leads or probes for damage before use.
- Use the accessories supplied with the product.
- Use the supplied replacement fuses or specified replacement parts.
- To prevent damage, always use and store your waveform generator in appropriate environments.
- Do not place the waveform generator in an area that is directly exposed to sunlight or under high humidity.
- Do not tamper with or disassemble the waveform generator, connectors or accessories. Internal damage will affect performance.
- Disconnect waveform generator from power source, vehicle and tablet before cleaning.
- When cleaning the waveform generator, use a damp, soft cloth with mild detergent. Do not allow water to enter the waveform generator casing.

7.2.9 General Introduction

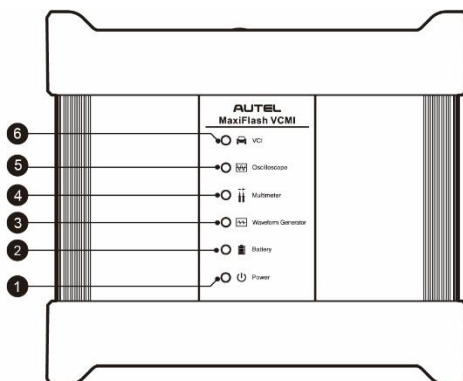
7.2.9.1 Component Locations

The multimeter jacks are used when operating the waveform generator. The two multimeter jacks are located on the top of the VCMI device.



1. Multimeter Jacks — for ground and signal cables
2. USB Port
3. Hook
4. DC Power Supply Input Port
5. Power Button

The waveform generator LED is located on the front panel of the VCMI device. When the VCMI is properly connected and powered on, the waveform generator LED lights green when operating in the waveform generator mode.



1. Power LED
2. Battery LED
3. Waveform Generator LED
4. Multimeter LED
5. Oscilloscope LED
6. Vehicle LED

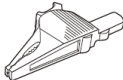
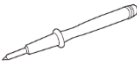


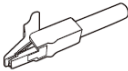



7.2.9.2 Technical Specifications

Table 7-11 Technical Specifications

Item	Description
Voltage Range	0.1 to 12 V
Frequency Output	1 Hz to 30 KHz
Duty Cycle Range	1 % to 99 % (1 Hz to 30 KHz)

7.2.9.3 Accessories

The following accessories are compatible with the waveform generator and oscilloscope.

 <p>Large Dolphin Clip</p>	 <p>Multimeter Probe</p>	 <p>Back-pinning Probe</p>
 <p>Battery Clip</p>	 <p>Small Crocodile Clip</p>	 <p>Flexible Back-pinning Probe</p>
 <p>Breakout Lead</p>	 <p>Multimeter Test Lead: used to connect the waveform generator and probe.</p> <p>NOTE: The two multimeter test leads (Red: SA015 / Black: SA016) are standard for the multimeter and waveform generator.</p>	

7.2.10 Getting Started

Before opening the waveform generator application, the VCMI device must be connected to the tablet via the provided USB cable or Wi-Fi network.

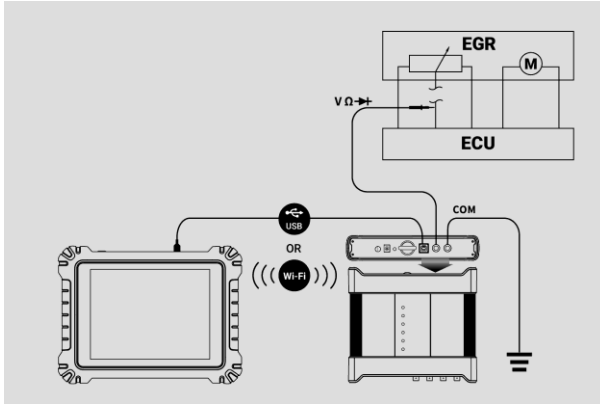


Figure 7-82 Connection Diagram

- **To open the waveform generator application**
 1. Insert the multimeter test lead ends into the multimeter jacks on the top of the VCMI device to complete the connection.
 2. Tap the **Measurement** icon on the Home screen of the MaxiSys tablet. The Measurement screen displays.
 3. Tap the **Waveform generator** icon to open the waveform generator Menu.
 4. Select a test to continue.

NOTE

Please check the waveform generator LED status indicator on the front panel of VCMI device. The waveform generator LED lights green when operating in the waveform generator mode.

7.2.11 Waveform Generator Update

The operating software of the waveform generator is continually optimized. Tap the **Help** button in the top toolbar and then tap the **Update the APK** button in the dropdown list to update the software.

Before update the waveform generator's software, please make sure the tablet has a stable Internet connection.

 **NOTE**

The acronym APK (Android Package Kit) is used on the tablet and in this manual. This file contains all the assets of a particular app. To update the APK, is to install the latest version of the app on your tablet.

➤ **To update the APK**

1. Tap the **Help** button on the upper half of the screen. A dropdown menu displays.



Figure 7-83 Help Screen

2. Tap the **Update the APK** in the dropdown menu. A confirmation message will display.

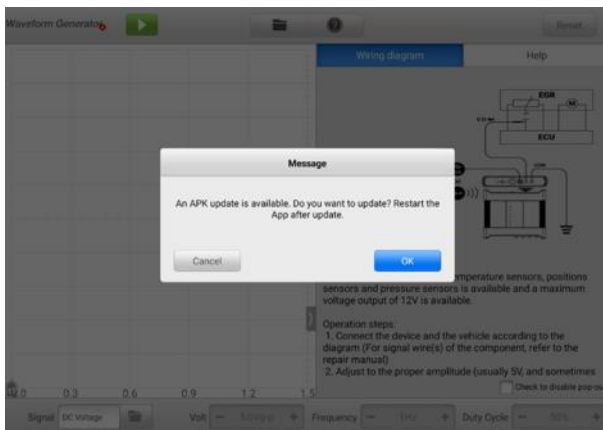


Figure 7-84 Update Confirmation Screen

3. Tap **OK** to update the software or tap **Cancel** to exit.

7.2.12 Screen Layout and Operations

Tap the **Measurement** icon on the Job Menu and select **Waveform generator** from the menu, the waveform generator page displays. The screen typically includes the following button sections.

NOTE

The **Waveform Generator** application can also be opened via the Android home screen. Tap the **Measurement** icon at the top of the Android home screen. Tap **Waveform Generator** icon.

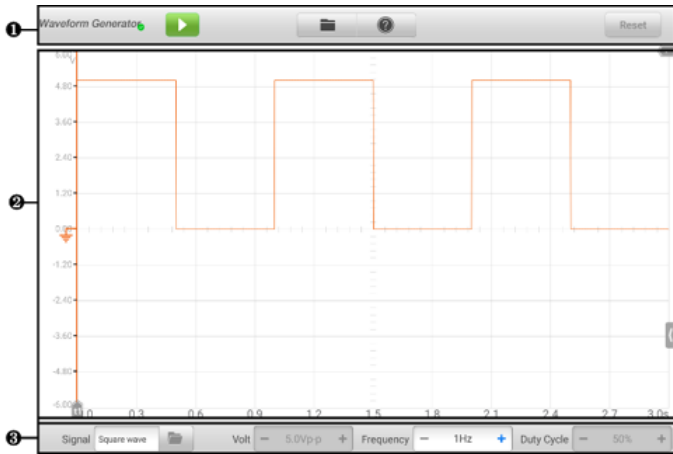


Figure 7-85 Waveform Generator Menu Screen


1. Upper Toolbar
2. Main Section
3. Lower Toolbar

7.2.12.1 Upper Toolbar

The upper toolbar is used to configure settings and operations. The following table provides brief descriptions of each button.

Table 7-12 Upper Toolbar

Button	Name	Description
	Waveform generator icon	Displays the waveform generator connection status.
	Start/Stop	Start and stop the waveform generator device.
	File	Print, open and save the waveform data.
	Help	View the user manual, and update the software.



Button	Name	Description
	Reset	Reset the configurations and refresh the screen.

- **Waveform Generator Icon**

This **Waveform Generator Icon** displays the waveform generator connection status. A **green** check mark means the tablet and the waveform generator are connected; a **red X** means the device and the tablet are not connected.

- **Start/Stop Button**

You can tap the **Start/Stop Button** icon to start or stop the waveform generator device.

Button	Name	Description
	Start	Tap to start the waveform generator.
	Stop	Tap to stop the waveform generator.

- **File Menu**

The file menu supports the following functions.

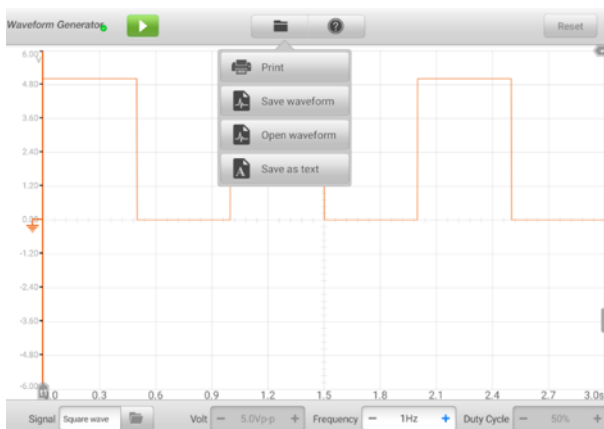


Figure 7-86 File Menu Screen

- ✓ **Print** — tap to create and print a temporary PNG picture of the current waveforms.

🔗 **NOTE**

Ensure the tablet is configure to print (see Printer setup instructions) and is connected to the printer. Ensure the tablet and printer share the same network.

- ✓ **Save Waveform** — tap to capture and save the current waveform. On the Save File screen, tap each item to input the corresponding information and then tap **Save** or **Save Default** to finish.

🔗 **NOTE**

You must name the file to save the waveform.

- ✓ **Open Waveform** — tap to retrieve the saved waveforms. Tap the **Edit** button in the upper right corner of the screen to select and delete the saved waveform.
- ✓ **Save as text** — tap to save the current waveform data to a text file. Use the ES File Explorer app on the Android home screen to review file: **Home > ES File Explorer > Local > Internal Storage > Scan > Data > Signal > txt.**

- **Help Menu**

The Help Menu allows you to view the user manual, update the software, and view versions of the device.



Figure 7-87 Help Menu Screen

- ✓ **User Manual** — displays instruction for the proper use of the waveform generator.
- ✓ **Update the APK** — connects to the Autel server and get the latest application software version.
- ✓ **About** — displays the model numbers and the installed versions of the software.

7.2.12.2 Main Section

The main section screen displays as a coordinate grid with **X-axis** and **Y-axis**, representing the duration and amplitude level respectively.

- **Channel Selection**

In the main section, a channel has two conditions: selected and unselected. A channel must be selected in order for the waveform to be movement, to use the zoom-in or to add measurement rulers.

- **To select and unselect the channel**

1. Tap the Zero Baseline marker or the Y-axis (the line thickens when selected).
2. Tap the Zero Baseline marker or the Y-axis again to exit the channel selection.

- **Waveform Zooming**

The zooming function allows you to change the size and position of a signal during or after capturing a waveform to examine it in greater details. It does not change the stored data, only the way it displays.

The X-axis and Y-axis can be zoomed using your fingertips. The waveform can be zoomed during or after capturing the signal.

- **Measurement Ruler**

In the coordinate grid, there are two types of **measurement rulers**, which allow the amplitude and duration of a waveform to be measured precisely. They are useful when determining signal characteristics such as amplitude at specific points, and the cycle time (duration).

The vertical **Time Ruler** — tap the **Ruler Activator** in the lower left corner of the grid and drag it across the screen to the desired position. A **Time Ruler** is generated.

The horizontal **Signal Ruler** — the **Signal Ruler** can be generated in the similar way by clicking the **Ruler Activator** in the upper right corner and dragging it downwards.

When dragging the Measurement Rulers, a **Ruler Table** showing time and voltage values will be displayed. The **Delta** icon refers to the absolute difference between

the values of the rulers, which can be locked by tapping the **Lock** icon. Tap the **X** button in the upper right corner of the ruler table to delete all rulers.

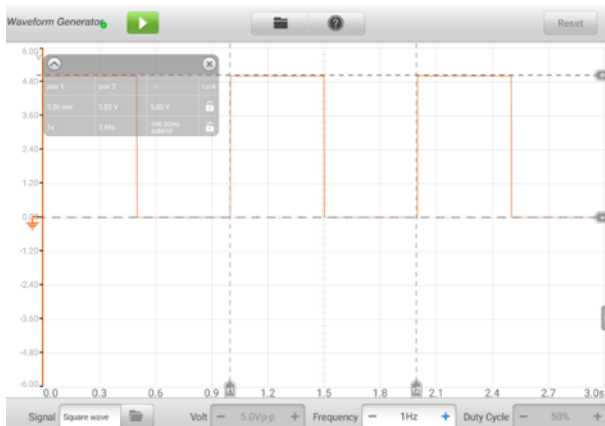


Figure 7-88 Measurement Rulers Screen

- **Zero Baseline**

The Zero Baseline is marked as the 0 value in the Y-axis, showing the ground level of each channel waveform. After the channel is selected, the Zero Baseline can be adjusted by dragging the Zero Baseline marker up/down along the Y-axis.

- **Wiring Diagram and Help**

Tap the arrow button in the lower right corner of the screen to open the Wiring Diagram and Help window.

The **Wiring Diagram** function provides the connection diagram, operation steps and operation notes.

The **Help** function provides the content-sensitive help, displaying information relevant to the procedure, operation or instructions.

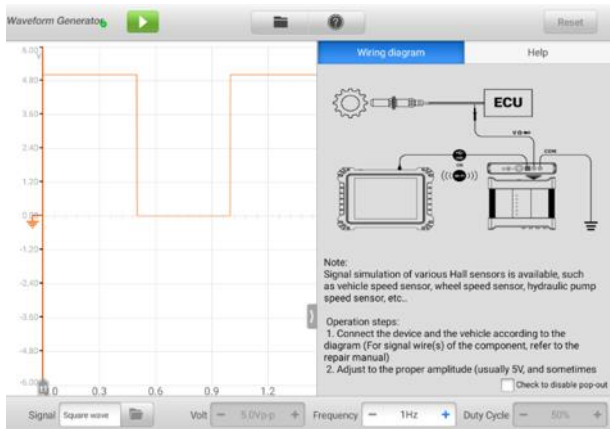


Figure 7-89 Wiring Diagram and Help Screen

- **To open and close the Wiring Diagram and Help window**
 1. Tap the arrow button on the right-hand side of the screen.







Figure 7-90 Arrow Button Position Screen

2. The Wiring Diagram and Help window displays.
3. Tap the arrow button again or tap any space outside of the window.

7.2.12.3 Lower Toolbar

The signal mode, voltage, frequency and duty cycle can be configured via the lower toolbar.

Table 7-13 Lower Toolbar

Button	Name	Description
	Signal Mode Setting	Tap to select an appropriate signal mode.
	Voltage Setting	Tap to select an appropriate voltage value.
	Frequency Setting	Tap to select an appropriate frequency value.
	Duty Cycle Setting	Tap to select an appropriate duty cycle value.

- **Signal Mode Setting**

The waveform generator supports numerous signal modes including the DC voltage, square wave, square wave (X+Y), triangle wave, and actuators drive, and arbitrary waveform.

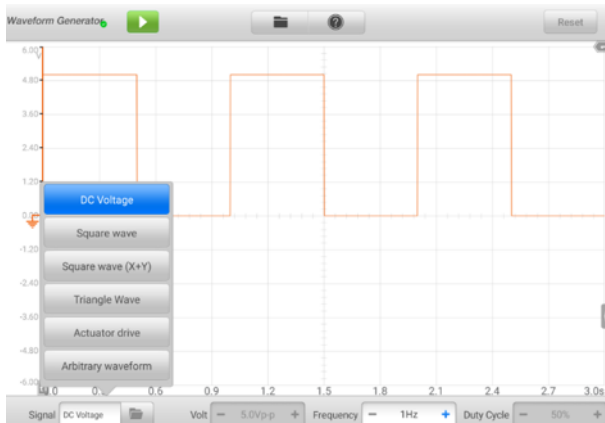


Figure 7-91 Signal Mode Setting Screen

✧ **DC Voltage**

Set the DC voltage in the waveform generator interface. The waveform generator can simulate the signals of numerous sensors including the water temperature sensor, oil pressure sensor, and position sensor and then feed back to the engine ECU.

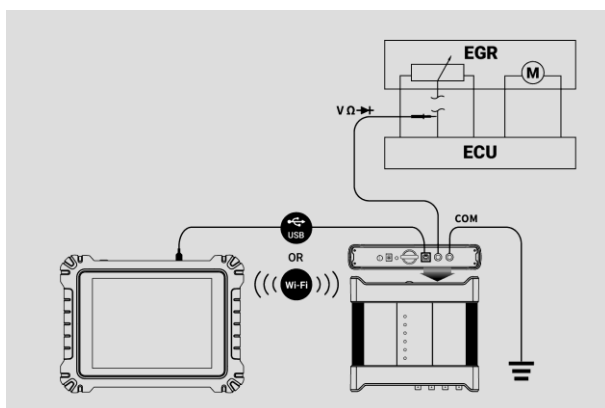


Figure 7-92 DC Voltage Connection Diagram

◇ Actuator Drive

This function can drive 2-wire solenoid valve, solenoid coil, and low-power motor, including the canister solenoid valve, injector solenoid valve, transmission hydraulic valve, hydraulic control valve, ignition coil, idle motor, and throttle motor.

It can change the operation speed and working time of the actuator by setting the frequency and duty cycle. The higher the frequency, the faster the speed, the higher the duty cycle, and the longer the working time, and vice versa.

NOTE

1. To avoid damaging the actuator, do not actuate it for a long time, and do not set too high a frequency.
2. This function needs to be tested on the car. If the actuator is removed, it cannot be driven individually.
3. The maximum current supported by Actuator Drive cannot exceed 1.9 A.

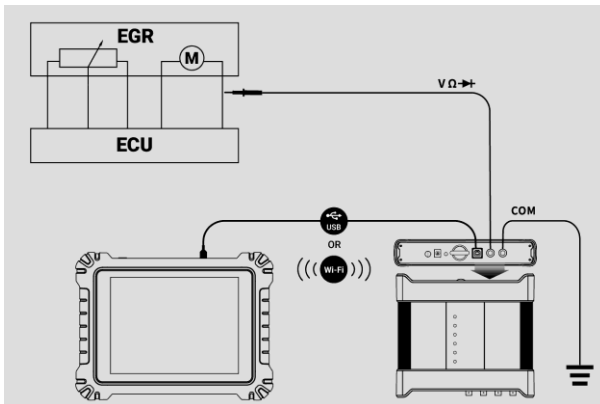


Figure 7-93 Actuator Drive Connection Diagram

◇ Square Wave

Once the voltage and frequency are set in the waveform generator interface, the square wave signals simulate the signals of various Hall sensors.

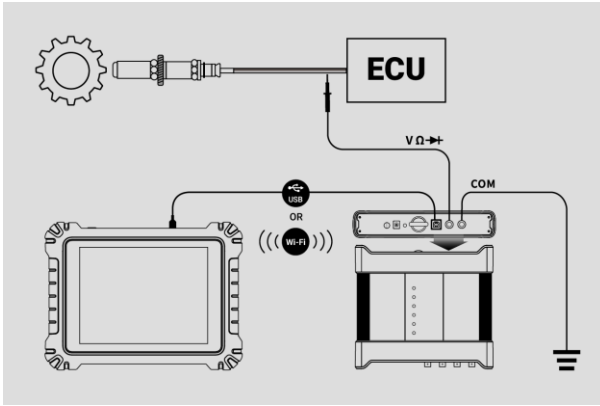


Figure 7-94 Square Wave Connection Diagram

◇ **Square Wave (X+Y)**

This function is mainly used to simulate the missing tooth signals of Hall-type crankshafts and camshafts. The X value represents the normal tooth signal and the Y represents the missing tooth signal. The default setting is 58+2, which can be adjusted as needed.

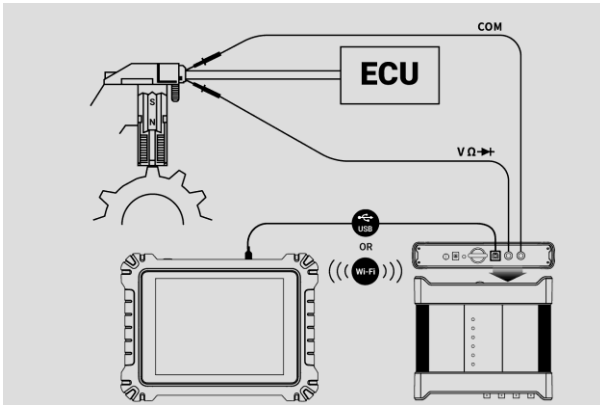


Figure 7-95 Square Wave (X+Y) Connection Diagram

◇ Triangle Waveform

This is a symmetrical triangular waveform, which is mainly used to simulate the triangle wave signals. The amplitude and frequency can be configured in this waveform.

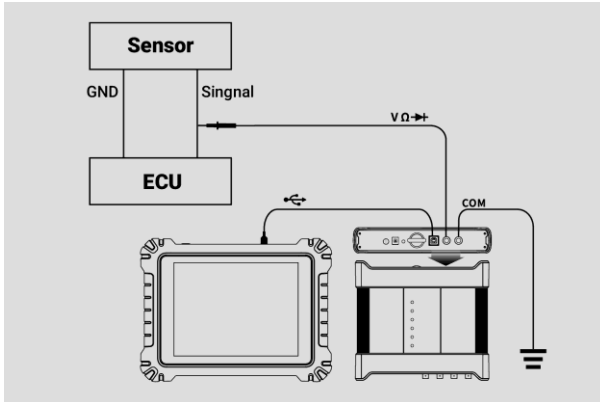


Figure 7-96 Triangle Waveform Connection Diagram

◇ Arbitrary Waveform

Any type of the mentioned waveforms can be loaded again after the waveform and parameter settings are saved.

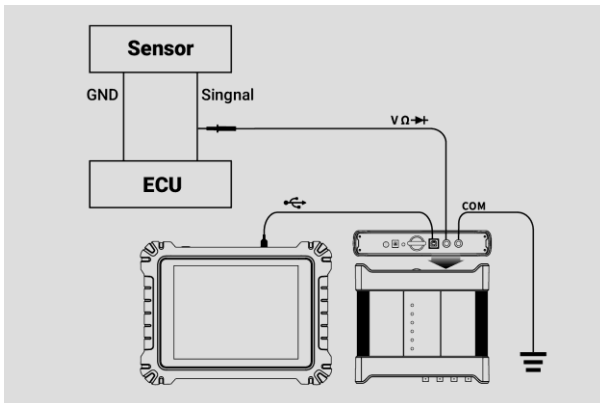


Figure 7-97 Arbitrary Waveform Connection Diagram

- **Voltage Setting**

After you select the waveform mode, you can also set the amplitude value for that mode.

There are **three methods** to adjust the voltage value:

Method 1: Tap the **"+" and "-" buttons** at the bottom of the screen in the Voltage Setting.

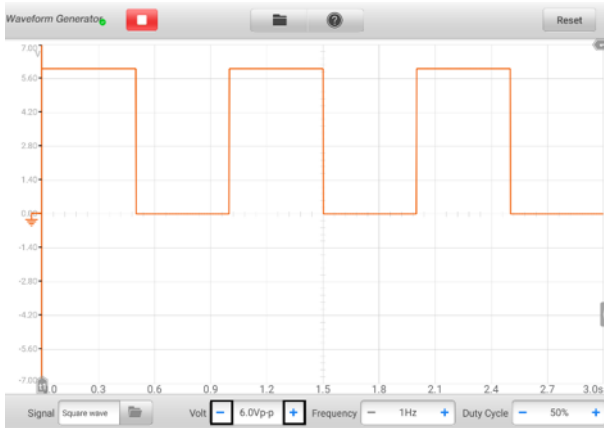






Figure 7-98 Voltage Setting Screen 1

Range	Button	Description
0.1V to 0.9 V		Raises the voltage by 0.1 V
		Lowers the voltage by 0.1 V
1V to 12 V		Raises the voltage by 1 V
		Lowers the voltage by 1 V

Method 2: Tap the **Voltage Setting** button at the bottom of the screen to open a dialog box. Adjust the voltage value by tapping the **positive or negative value** at the bottom of the dialog box. Then tap **OK** to confirm or tap **Cancel** to exit without

saving.

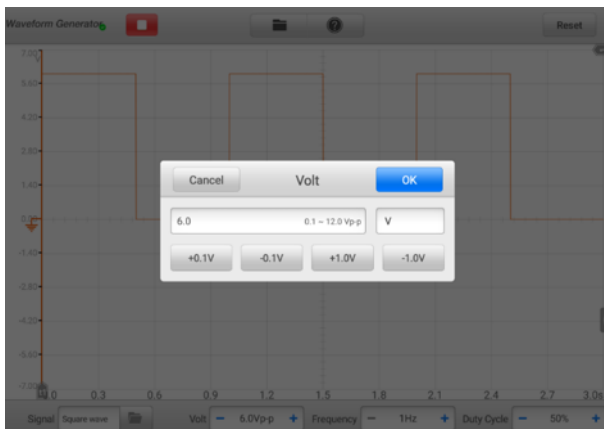


Figure 7-99 Voltage Setting Screen 2

Value	Description
+0.1 V	Raises the voltage by 0.1 V
-0.1 V	Lowers the voltage by 0.1 V
+1.0 V	Raises the voltage by 1 V
-1.0 V	Lowers the voltage by 1 V

Method 3: Input the voltage value using the virtual keyboard. Tap the voltage field to clear the current value and input the new value. Tap **OK** to confirm or tap **Cancel** to exit without saving.

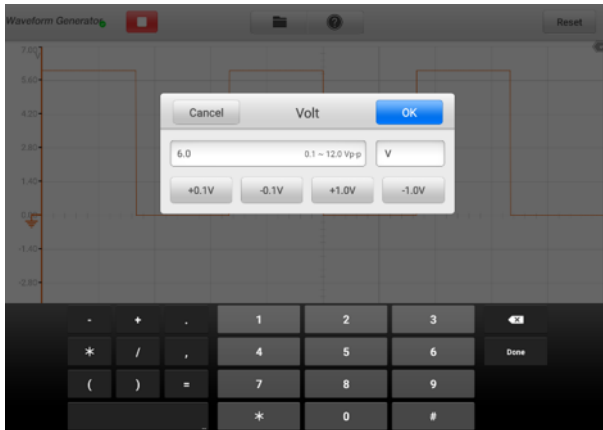


Figure 7-100 Voltage Setting Screen 3

- **Frequency Setting**

When the waveform mode is selected and the waveform generator is operating, you can also set the frequency value for that mode.

There are also three methods to adjust the frequency value:

Method 1: Tap the “+” and “-” buttons at the bottom of the screen in the Frequency Setting.

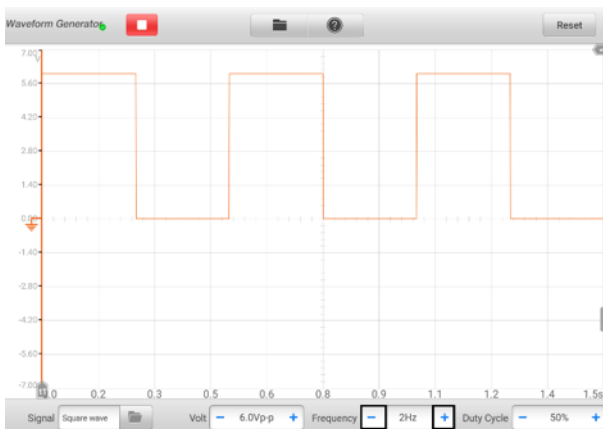










Figure 7-101 Frequency Setting Screen 1

Range	Button	Description
1 Hz to 10 Hz		Raises the frequency by 1 Hz
		Lowers the frequency by 1 Hz
10 Hz to 100 Hz		Raises the frequency by 10 Hz
		Lowers the frequency by 10 Hz
100 Hz to 1000 Hz		Raises the frequency by 100 Hz
		Lowers the frequency by 100 Hz
1.0 KHz to 30.0 KHz		Raises the frequency by 1 KHz
		Lowers the frequency by 1 KHz

Method 2: Tap the **Frequency Setting** button at the bottom of the screen to open a dialog box. Adjust the frequency value by tapping the **positive or negative value** at the bottom of the dialog box. The unit of the frequency can be switched Hz to KHz. Tap **OK** to confirm or tap **Cancel** to exit without saving.

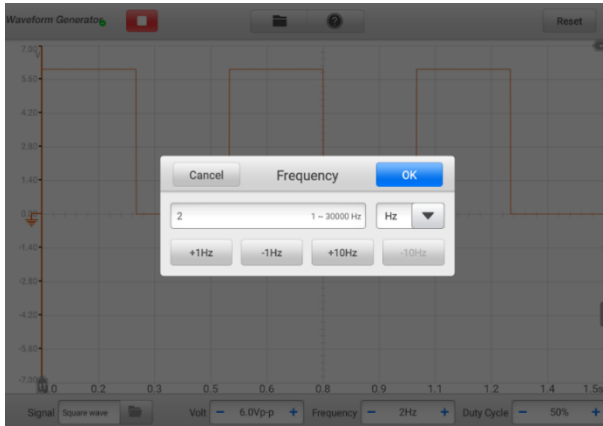


Figure 7-102 Frequency Setting Screen 2

Value	Description
+1.0 Hz	Raises the frequency by 1Hz
-1.0 Hz	Lowers the frequency by 1Hz
+10.0 Hz	Raises the frequency by 10Hz
-10.0 Hz	Lowers the frequency by 10Hz
+1.0 KHz	Raises the frequency by 1KHz
-1.0 KHz	Lowers the frequency by 1KHz

Method 3: Input the frequency value using the virtual keyboard. Tap the frequency field to clear the current value and input the new value. Tap **OK** to confirm or tap **Cancel** to exit without saving.

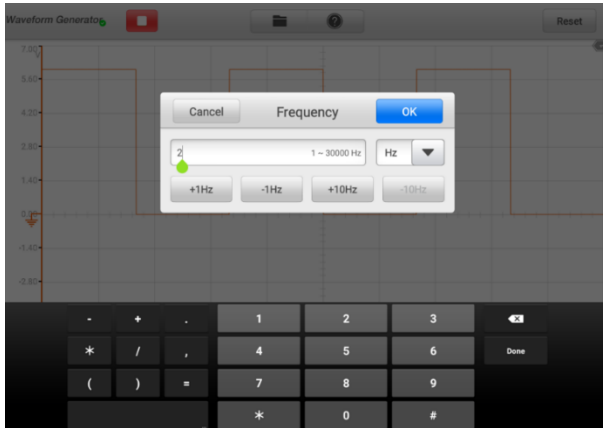


Figure 7-103 Frequency Setting Screen 3

- **Duty Cycle Setting**

When the waveform mode is set, you can also set the duty cycle ratio for that mode.

There are three methods to adjust the duty cycle ratio:

Method 1: Tap the “+” and “-” buttons at the bottom of the screen in the Duty Cycle Setting.

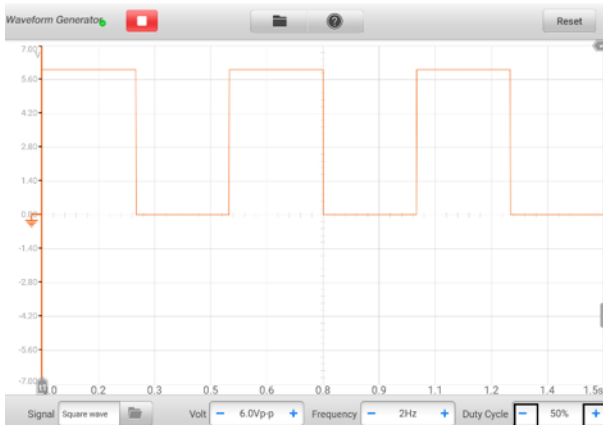




Figure 7-104 Duty Cycle Setting Screen 1

Range	Button	Description
1% to 99%		Raises the duty cycle ratio by 1%
		Lowers the duty cycle ratio by 1%

Method 2: Tap the **Duty Cycle Setting** button at the bottom of the screen to open a dialog box. Adjust the duty cycle by tapping the **positive or negative ratio** at the bottom of the dialog box. Tap **OK** to confirm or tap **Cancel** to exit without saving.

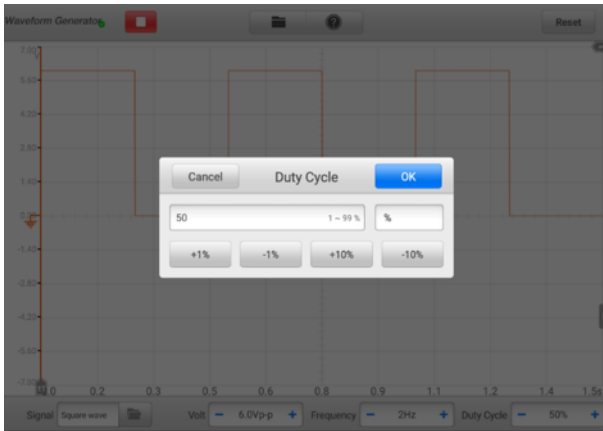


Figure 7-105 Duty Cycle Setting Screen 2

Value	Description
+1.0%	Raises the duty cycle ratio by 1.0%
-1.0%	Lowers the duty cycle ratio by 1.0%
+10.0%	Raises the duty cycle ratio by 10%
-10.0%	Lowers the duty cycle ratio by 10%

Method 3: Input the duty cycle ratio using the virtual keyboard. Tap the duty cycle field to clear the current value and input the new value. Tap **OK** to confirm or tap **Cancel** to exit without saving.

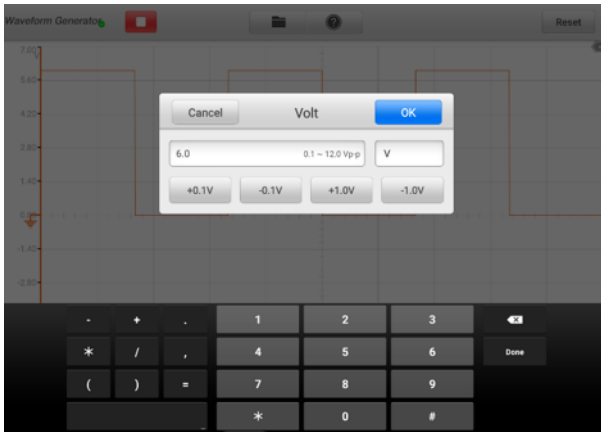


Figure 7-106 Duty Cycle Setting Screen 3

7.2.13 Troubleshooting



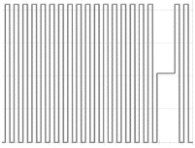

If the waveform generator cannot communicate with the tablet:

- Check if the VCMI is properly connected to the tablet through the supplied USB cable.
- If the communication between the VCMI and the tablet still fails, restart the tablet and reconnect the VCMI.

! IMPORTANT

To avoid damaging the vehicle and the equipment, all vehicle communications must be terminated before resetting the connection. The Internet connection may be aborted during resetting.

7.2.14 Glossary

Waveform Type	Description	Sample Waveform
DC Voltage	A waveform with constant voltage	
Square Wave	The voltage waveform is a rectangular periodic signal	
Square Wave (X+Y)	A waveform signal of automobile crankshaft	
Triangle Wave	Periodic signal with triangular voltage waveform	

7.3 Bus Inspection

Bus Inspection is an instrument that detects the communication status of CAN Bus. When the VCMI (Vehicle Communication and Measurement Interface) device is connected with the MaxiSys tablet, you can open the **Bus Inspection** application by tapping the **Measurement** icon on the Home screen of the tablet and then tapping the **OBD** icon, and perform the OBD-related functions including the signal detection. The indicator light flashes if the signals are detected. The indicator light displays in gray if no signal is detected.

Generally, the vehicle's electronic control systems are designed to comply with the specific communication protocols. The control units in the electronic control systems communicate with the Tablet through the OBDII (DLC) adapter.

With the Bus Inspection function, you can check whether the control units in vehicle's

electronic control systems work properly or not with the indicator light according to the condition of sending out the communication signals.

7.3.1 Safety Information

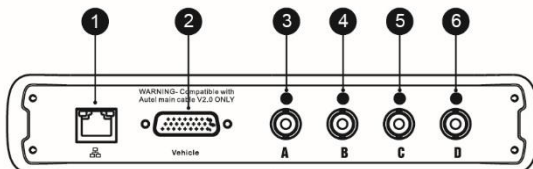
Follow the instructions below to ensure proper CAN Bus check performance.

- Different preconditions for different functions. Before check, please read the inspection guides carefully.
- The pin number for OBDII varies by vehicle modes. Please check and confirm for correct pin number and then proceed inspection.
- Select OBDII connector's signal pins manually if the test vehicle's actual communication signal pins are assigned differently.
- Ensure the DLC main cable is connected to the vehicle before inspection.
- Ensure the ignition key is in ON position when testing the vehicle's communication line.
- If the inspection fails due to no signal input, consult vehicle circuit diagram to ensure correct communications are being tested.
- Do not use in wet or damp conditions, or around explosive gas or vapor.
- Do not tamper with or disassemble the product, connectors or accessories. Internal damage will affect performance.
- Disconnect the product from power source, vehicle and tablet before cleaning.
- When cleaning the product, use a damp, soft cloth with mild detergent. Do not allow water to enter the product casing, as this will cause damage to the electronics inside.

7.3.2 General Introduction

7.3.2.1 Component Locations

The main connectors are located at the bottom of the VCMI device.



1. Ethernet Connector
2. Vehicle Data Connector

3. Input Channel A
4. Input Channel B
5. Input Channel C
6. Input Channel D

7.3.2.2 Getting Started

Before opening the OBDII CAN Bus Inspection application, you have to complete three steps below:

- 1) Connect the VCMI device to the tablet via Wi-Fi or the supplied USB cable.
- 2) Connect the VCMI device to the vehicle's OBDII connector.
- 3) Place the ignition in the key on position.

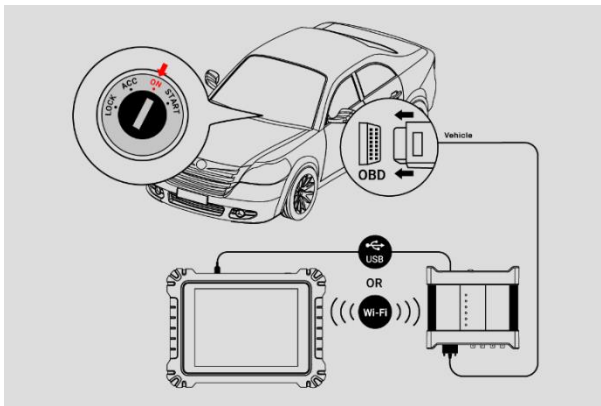


Figure 7-107 Connection Diagram

➤ To open the Bus Inspection application

1. Please refer to [Figure 7-107 Connection Diagram](#) to complete the connection. Place the ignition in the key on position.
2. Tap the **Measurement** icon on the Job Menu of the MaxiSys tablet. The Measurement screen opens.
3. Tap the **OBD** icon to open the Bus Inspection Menu.
4. Select a communication protocol to test.

7.3.3 Bus Inspection

The operating software of the device is continually optimized. Tap the **Help** button in the top toolbar and then tap the **Update the APK** button in the dropdown list to update the software.

Before update the device's software, please make sure the tablet has a stable Internet connection.

7.3.3.1 APK Update

NOTE

The acronym APK (Android Package Kit) is used on the tablet and in this manual. An APK file contains all the assets of a particular app. Updating an APK means to install the latest version of the app on your tablet.

➤ **To update the APK**

1. Tap the **Help** button on the upper half of the screen. A dropdown menu displays.

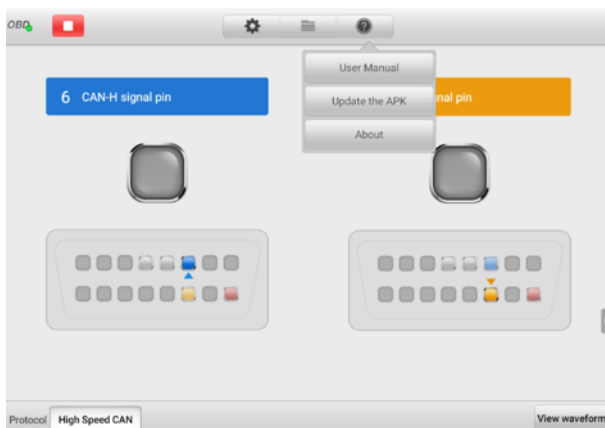


Figure 7-108 Help Screen

2. Tap **Update the APK** in the dropdown menu. A confirmation message will display.

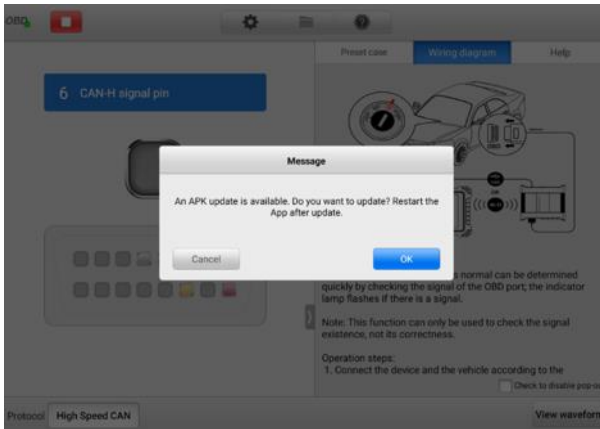


Figure 7-109 Update Confirmation Screen

3. Tap **OK** to update the software or tap **Cancel** to exit.

7.3.4 Screen Layout and Operations

The Bus Inspection application allows you to select the communication protocols, the signal pins and voltage value for testing.

Tap the **Measurement** icon on the Job Menu and select **OBD** in the menu, the Bus Inspection window displays. The screen typically includes the following button sections.

NOTE

The Bus Inspection application can also be opened via the Android home screen. Tap the **Measurement** icon at the top of the Android home screen. Tap the **OBD** app icon.

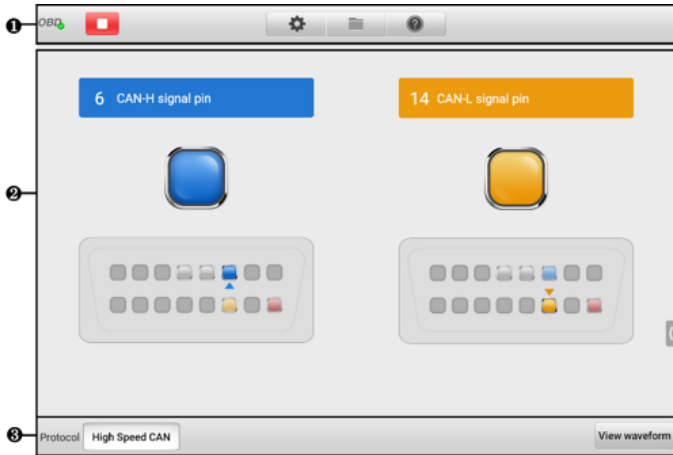


Figure 7-110 Bus Inspection Screen


1. Upper Toolbar
2. Main Section
3. Lower Toolbar

7.3.4.1 Upper Toolbar

The upper toolbar is used for configurations of various settings and operations. The following table provides brief descriptions of each button.

Table 7-14 Upper Toolbar

Button	Name	Description
	OBD Icon	Displays the device connection status.
	Start/Stop	Starts or stops the device.
	Settings	Sets the communication protocol pins manually.
	File	Prints, opens and saves the waveform data.



Button	Name	Description
	Help	Views the user manual and update the software.

- **OBD Icon**

This OBD button indicates the OBD device connection status. A green check mark means the VCMI and the tablet are connected; a red “X” indicates no connection has been established.

- **Start/Stop Button**

You can tap the **Start/Stop Button** icon to start or stop the device.

Button	Name	Description
	Start	Tap to start the device.
	Stop	Tap to stop the device.

- **Settings Menu**

Tap the gear-shaped icon in the top navigation bar to enter the **Settings Menu**.

The pin number for OBDII may be different for different vehicle modes. In Settings Menu, you can select OBDII connector's signal pins manually if the test vehicle's actual communication signal pins are assigned differently.



Figure 7-111 Settings Menu Screen 1

At the bottom of the settings menu screen, the **Protocol**, **Reset**, **Save**, and **Close** buttons are displayed. The protocol varies according to the protocol you set.

Take CAN protocol as an example.

CAN-H: select the pin assigned for high-speed CAN-bus communication line

CAN-L: select the pin assigned for low-speed CAN-bus communication line

Reset: restore the default settings

Save: save the changes when custom pin assignment is set

Close: exit the settings menu screen

➤ **To select the signal pins manually**

1. Tap the gear-shaped icon in the upper toolbar to enter the **Settings Menu**.
2. Tap **CAN-H** or **CAN-L** to select the communication protocol pins.



Figure 7-112 Settings Menu Screen 2

3. Tap the correct pin number in the OBDII Connector Assignment image to match the test vehicle's actual communication signal pins.



Figure 7-113 Settings Menu Screen 3

4. Tap **Save** to save changes or tap **Close** to exit.

- **File Menu**

The **File** Menu allows you to print, open and save the waveform data. The **File Menu** is enabled in the **Waveform Mode** and supports the following functions.

- ✓ **Print** — tap to create and print a temporary PNG picture of the current waveforms.

🔗 **NOTE**

Ensure the tablet is configure to print (see Printer setup instructions) and is connected to the printer. Ensure the tablet and printer share the same network.

- ✓ **Save Waveform** — tap to capture and save the current waveforms. On the Save File screen, tap each item to input the corresponding information and then tap **Save** or **Save Default** to finish.

🔗 **NOTE**

A file name is required to save the waveform.

- ✓ **Open Waveform** — tap to retrieve the saved waveforms. To select and delete the saved waveform, tap the **Edit** button in the upper right corner of the screen.
- ✓ **Save as text** — tap to save the current waveform data to a text file. Use the ES File Explorer app on the Android home screen to review file: **Home > ES File Explorer > Local > Internal Storage > Scan > Data > OBD > txt.**

- **Help Menu**

The Help Menu allows you to view the user manual, update the software, and view versions of the device.

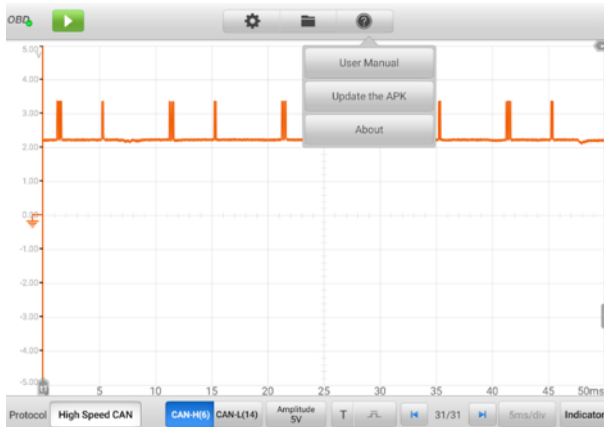


Figure 7-114 Help Menu Screen

User Manual — displays instruction for the proper use of the OBDII CAN Bus Check application and the MaxiSys tablet.

Update the APK — connects to the Autel server and get the latest application software version.

About — displays the model number and the installed versions of the software.

7.3.4.2 Main Section and Lower Toolbar

Two modes are available in the OBD communication line inspection function: Indicator Mode and Waveform Mode.

A. Indicator Mode

This mode is designed to show the condition of voltage fluctuation in vehicle's communication lines. In this mode, the indicator light of a selected pin flashes when the electronic control units are sending signals properly.

The Indicator Mode displays by default.

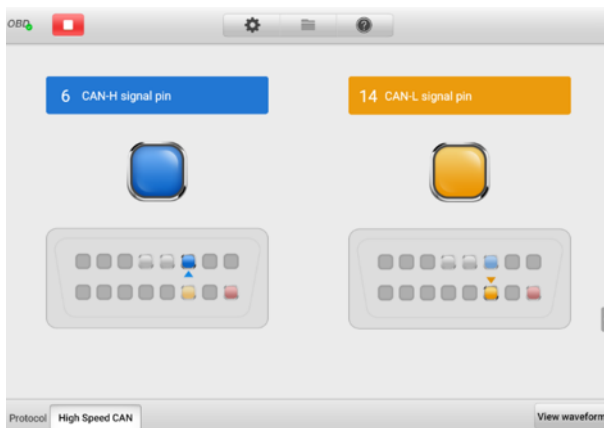


Figure 7-115 Indicator Mode Screen

Main Section

The **CAN-High** line is assigned to **Pin 6** and the **CAN-Low** line is assigned to **Pin 14** of the OBDII adapter by default according to the **CAN-Bus** standard protocol.

If the test vehicle's actual communication signal pins are assigned differently, you can select OBDII connector's signal pins manually in the Settings menu.

When the electronic control units send out signals properly, the left and right indicator lights will flash consecutively on the screen.

NOTE

The flashing indicator lights serve to confirm only that communication signals have been detected.

Lower Toolbar

- Protocol — in the left-lower corner of the screen, you can select the protocol you want to test.



Figure 7-116 Protocol Button Screen

The following protocols are included:

- ✧ **High Speed CAN** — offers baud rates from 40 Kbit/s to 1 Mbit/sec, depending on cable length. This is the most popular standard for the physical layer, since it allows for simple cable connection between devices. High speed CAN networks are terminated with 120 ohm resistors on each end of the network.
- ✧ **Low Speed CAN** — offers baud rates from 40 Kbit/s to 125 Kbits/sec. This standard allows CAN bus communication to continue in case of a wiring failure on the CAN bus lines. In low speed CAN networks, each device has its own termination.
- ✧ **Single CAN** — offers baud rates up to 33.3 Kbit/s (up to 88.3 Kbit/s for high-speed mode)
- ✧ **J1939 CAN** — is used in the commercial vehicle area for communication throughout the vehicle with the physical layer defined in ISO 11898. Under J1939/11 and J1939/15, the data rate is specified as 250 Kbit/s, with J1939/14 specifying 500 Kbit/s.
- ✧ **J1850 (PWM)** — SAE J1850 pulse-width modulation offers baud rates up to 41.6 Kbit/s, standard of the Ford Motor Company
- ✧ **J1850 (VPW)** — SAE J1850 variable pulse width offers baud rates up to 10.4 Kbit/s, standard of the General Motors
- ✧ **J1708 (SAE)** — the standard defines a double-wire 18-gauge cable that can run up to 130 feet (40 m) and operates at 9600 bit/s

- View Waveform — in the right-lower corner of the screen, you can enter to the Waveform Mode by tapping the **View Waveform** button.

Test Procedure

The test procedure is the same for all the protocols.

➤ To test the communication line

Using High speed CAN-bus line as an example.

1. Make sure the VCMI is connected to the vehicle's OBDII connector. The VCMI is connected with tablet successfully.
2. Place the ignition in the key ON position.
3. Tap the **Measurement** icon on the Job Menu of the MaxiSys tablet. The Measurement screen opens. Tap the **OBD** icon to open the OBD menu screen. Select the **High Speed CAN** protocol in the lower corner of the screen.
4. Tap the **Start** button on the upper-left corner of the screen to start the device. The OBDII connector pin number that the signals are using is indicated, and the indicator light flashes if the signals are detected. Otherwise, the indicator light displays in gray.



NOTE

If the indicator light is not flashing, ensure the ignition is in the key ON position and that signal pin assignment is correct.

B. Waveform Mode

This mode allows you to view the test result in a waveform form. This mode offers greater details and offers a larger number of configuration options.

The screen is displayed in the Indicator mode by default.

Tap the **View Waveform** button in the lower corner of the Indicator Mode screen to switch to the Waveform Mode. The screen is shown as below.

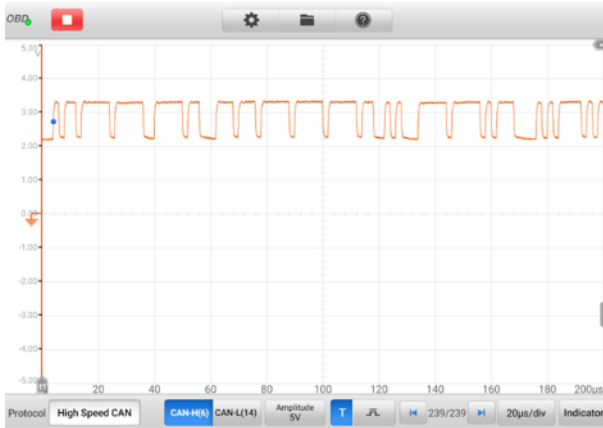


Figure 7-117 Waveform Mode Screen

Main Section

The main section features a coordinate grid with **X-axis** and **Y-axis**, representing the time duration and amplitude level respectively. The amplitude level can be configured in the Amplitude Settings and the time duration can be set in the Time Base Settings.

✧ Channel Selection

Each channel has two conditions: selected and unselected. Some operations depend on the selected condition of the channel, such as measurement rulers, waveform movements and waveform zooming.

➤ To select and unselect the channel

1. Tap the Zero Baseline marker or the Y-axis (the line thickens when selected).
2. Tap the Zero Baseline marker or the Y-axis again to exit the channel selection.

✧ Waveform Zooming

The zooming function allows you to change the size and position of a signal during or after capturing a waveform to examine. It does not change the stored data, only the way it displays.

The X-axis and Y-axis can be zoomed using your fingertips. The waveform can be zoomed during or after capturing the signal.

❖ Measurement Rulers

In the coordinate grid, there are two types of **measurement rulers**, which allow the amplitude and time duration of a waveform to be measured precisely. They are useful when determining signal characteristics such as amplitude at specific points, the cycle time (duration) and frequency.

The vertical **Time Ruler** — tap the **Ruler Activator** in the bottom left corner of the grid and drag it across the screen to the desired position. A **Time Ruler** is generated.

The horizontal **Signal Ruler** — the **Signal Ruler** can be generated in the similar way by clicking the **Ruler Activator** in the top right corner and dragging it downwards.

When dragging the Measurement Rulers, a **Ruler Table** showing time and voltage values for the corresponding channels will be displayed. The **Delta** icon refers to the absolute difference between the values of the rulers, which can be locked by tapping the **Lock** icon. Tap the **X** button in the upper right corner of the ruler table to delete all rulers.

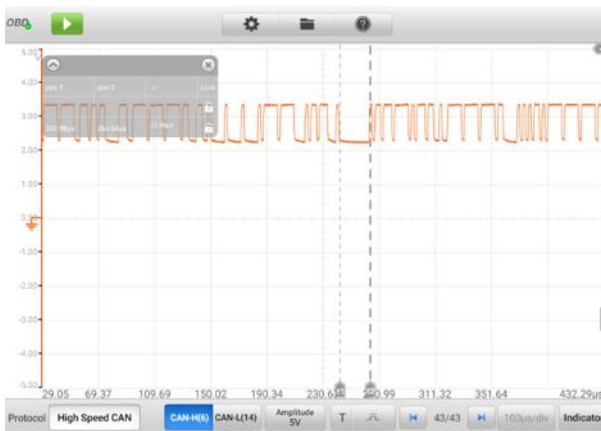


Figure 7-118 Measurement Rulers Screen

❖ Zero Baseline

The zero baseline is marked as the 0 value in the Y-axis, showing the base level of each channel waveform. After the channel is selected, the zero baseline can be adjusted by dragging the baseline marker up/down along the Y-axis, or dragging the waveform up/down or moving the screen up/down in the grid.

NOTE

Tap the baseline marker to make the vertical scale line thicker. In this case, the channel is selected. Tap the baseline marker again to unselect and the waveform cannot be dragged.

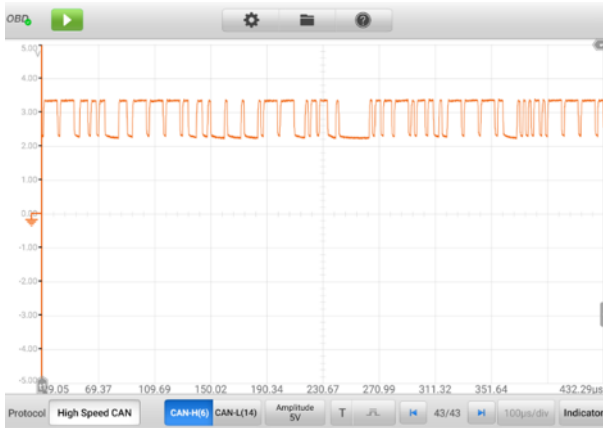





Figure 7-119 Zero Baseline Screen

Lower Toolbar

The protocol, buffer and time base can be configured at the lower toolbar.

Table 7-15 Lower Toolbar

Button	Name	Description
	Protocol	Tap to select an appropriate protocol.
	Communication Line	Tap to select the appropriate communication line.
	Amplitude	Tap to select an appropriate amplitude value.
	Trigger	Tap to open the trigger setting menu.

Button	Name	Description
	Buffer	Tap the Previous or Next button to switch to the previous or the next waveform.
	Time Base	Tap to select an appropriate time per division.
	Indicator	Tap to switch to the Indicator mode.

- **Protocol Setting**

Seven types of communication protocols are available: High Speed CAN, Low Speed CAN, Single CAN, J1939 CAN, J1850 (PWM), J1850 (VPW), and J1708 (SAE).

- **To select a protocol**

1. Tap the **Protocol** in the lower-left corner of the screen. A dialog box opens.

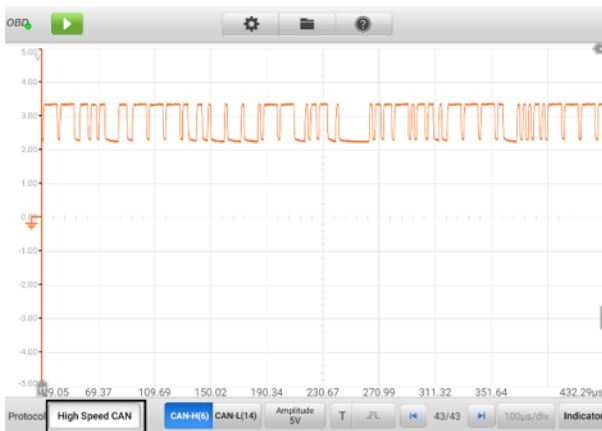


Figure 7-120 Protocol Type Button Screen

2. Select the desired **Protocol type** in the dialog box.

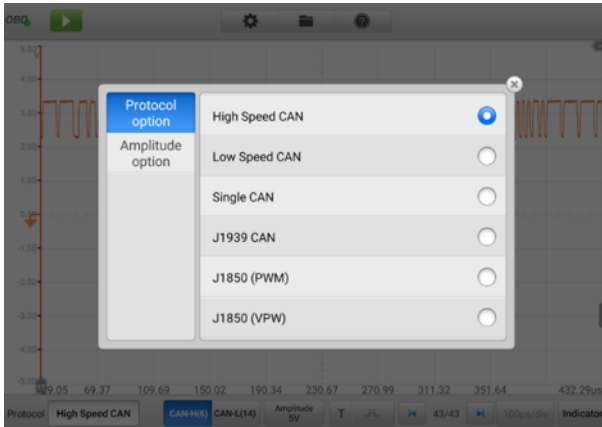


Figure 7-121 Protocol Setting Screen

3. Tap the “X” icon to close the dialog box.

- **Communication Line**

The communication line selection varies according to the protocol selected. Tap the appropriate communication line at the bottom of the screen.

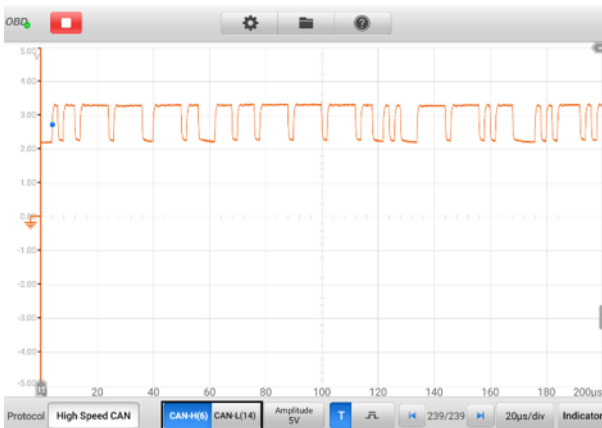


Figure 7-122 Communication Line Button Screen

- **Amplitude Setting**

After selecting the protocol type, you can also set the amplitude value for that type.

- **To set the amplitude**

1. Tap the **Amplitude** button at the bottom of the screen. A dialog box displays.

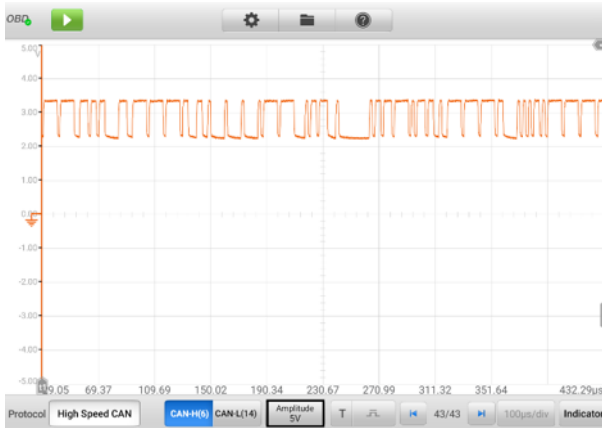


Figure 7-123 Amplitude Button Screen

2. Select the appropriate amplitude for the protocol.

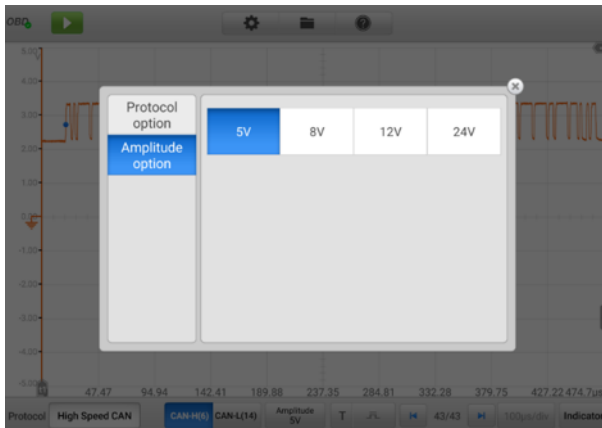


Figure 7-124 Amplitude Setting Screen

3. Tap the “X” icon to close the dialog box.

- **Trigger**

The trigger feature is used to filter and capture specified waveform data.

According to the trigger setting condition, the trigger waveform will be captured when the signal meets the trigger condition. When capturing waveforms, you can manually set the trigger conditions. When the device is capturing the signal, tap the left column of the **Trigger** button to activate the trigger function. A trigger point displays as a blue point.

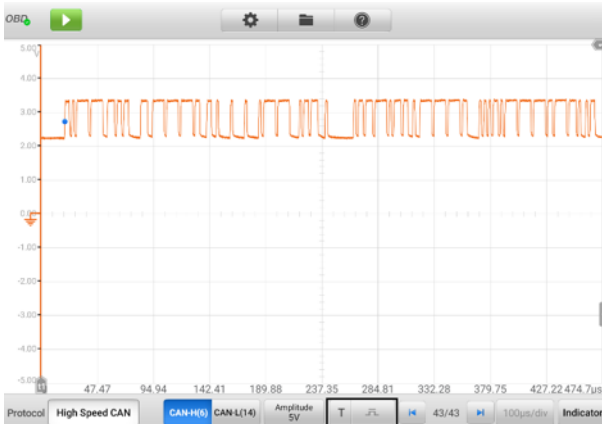


Figure 7-125 Trigger Button Screen

The edge trigger is one of the most common trigger modes and is activated when voltage rises above or falls below a preset threshold. This trigger type allows you to configure the trigger mode, threshold, trigger channel and pulse direction settings. Tap **Done** to save the settings or tap **Cancel** to exit without saving.

When the device is capturing the signal, tap the right column of the **Trigger** button to open the trigger settings dialog box.

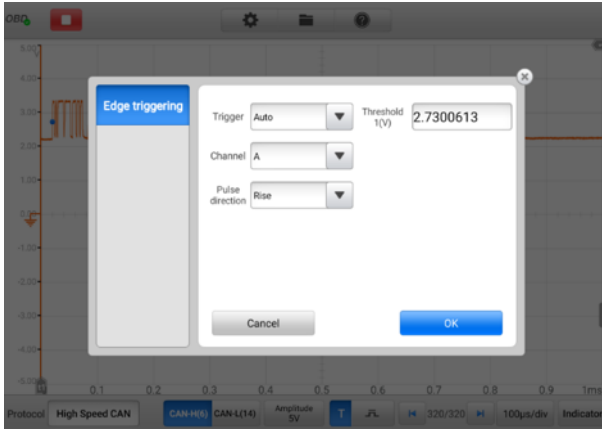


Figure 7-126 Trigger Settings Screen

✧ **Trigger Mode**

Three trigger modes are available: **None**, **Auto**, and **Repeat**.

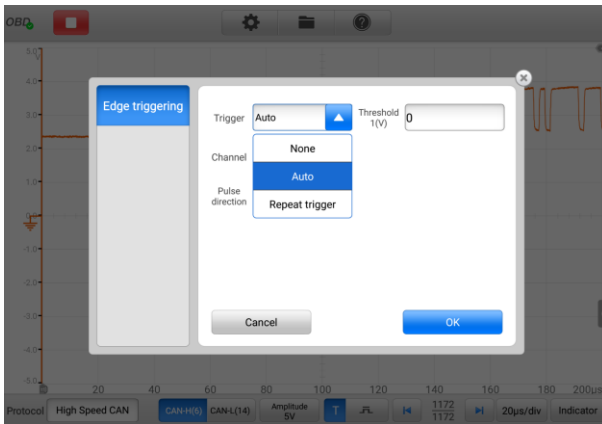


Figure 7-127 Trigger Mode Screen

The table below offers brief description of each trigger mode.

Table 7-16 Trigger Mode Table

Trigger Mode	Description
None	The oscilloscope can continuously capture data, without waiting for a trigger event.
Auto	The oscilloscope will wait for a trigger before capturing data. It can automatically update after a short period, even if the signal does not cross the trigger point.
Repeat trigger	The oscilloscope waits until a trigger event occurs. If there is no trigger event, nothing will be displayed on the screen.

✧ **Channel**

Select the applicable trigger channel from the dropdown menu. The selected channel is the communication line that the device monitors for the trigger condition.

✧ **Pulse Direction**

Two pulse direction settings are available: **Rise** and **Fall**.

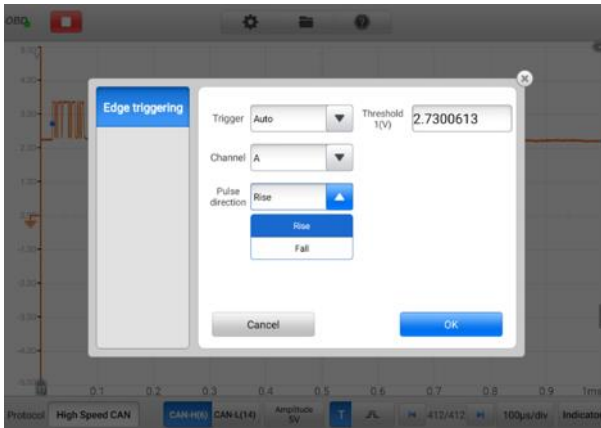


Figure 7-128 Pulse Direction Screen

Rising Edge Trigger — indicates trigger is turned on to start the trace on the rising edge of the waveform.

Falling Edge Trigger — indicates trigger is turned on to start the trace on

the falling edge of the waveform.

✧ **Threshold**

The **Threshold** allows you to set the voltage threshold for the trigger.

- ✓ To precisely position the trigger point, input the value in the Threshold field in the trigger settings dialog box.
- ✓ To roughly position the trigger point, drag the trigger point to a desired position.

➤ **To configure the trigger settings**

1. Tap the right column of the **Trigger** button to open the trigger settings dialog box.
2. Select the trigger mode, trigger channel and pulse direction in the dropdown list.
3. Input the value in the Threshold field in the trigger settings dialog box.
4. Tap **Done** to save settings or tap **Cancel** to exit without saving.

● **Buffer**

The waveform buffer shows which signal waveform is displayed on the current screen and how many signal waveforms are captured and stored in the buffer memory.

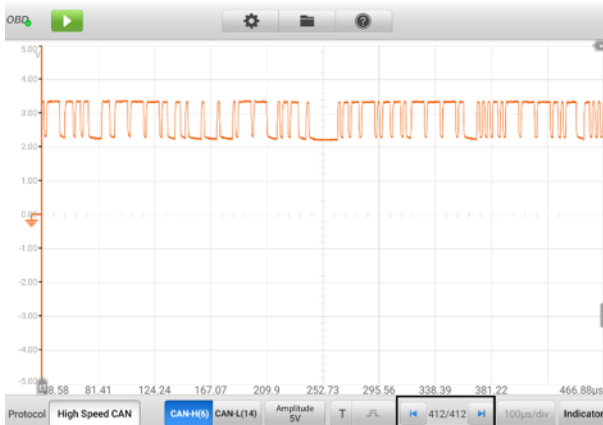

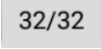



Figure 7-129 Buffer Screen

The device can capture and store waveforms. You can select a waveform from the waveform buffer by tapping the **Previous** or **Next** button.

Button	Name	Description
	Previous	Tap to display the previous waveform in the buffer.
	Buffer Index	Shows which waveform is currently being displayed and how many waveforms are in the buffer.
	Next	Tap to display the next waveform in the buffer.

- **Time Base**

The time base controls the time interval across the device display. Tap the **Time Base** button at the bottom to open the setting dialog box.

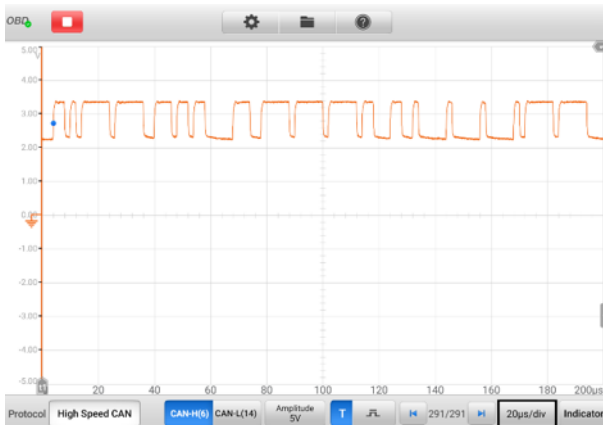


Figure 7-130 Time Base Screen 1



Figure 7-131 Time Base Screen 2

Continuous Mode: if the time base is set to more than or equal to 200ms/div, the device switches to the continuous mode. In this mode, the device updates the trace continuously as each capture progresses, rather than waiting for a complete capture before updating the trace.

- **Indicator Button**

In the lower corner of the screen, you can enter the Indicator Mode by tapping the **Indicator** button.

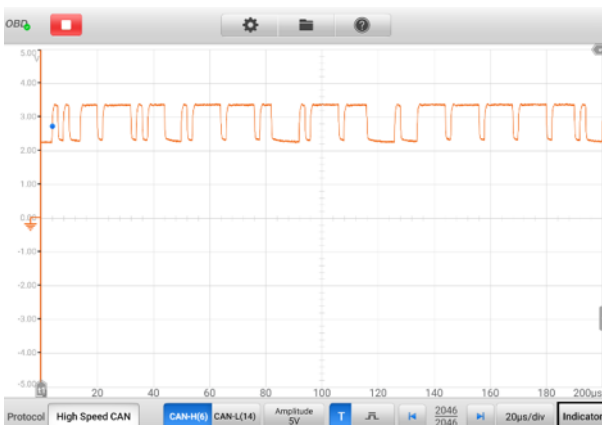


Figure 7-132 Indicator Button Screen

7.3.5 Troubleshooting

If the VCMI device cannot communicate with the MaxiSys tablet:

- Ensure the VCMI is properly connected to the MaxiSys tablet via Wi-Fi or with the supplied USB cable.
- Ensure the pin number is set properly.
- Ensure the ignition is in the Key **ON** position.
- Restart tablet and reconnect the VCMI if communication continues to fail.

7.3.6 Glossary

Vehicle Bus

A vehicle bus is a specialized internal communications network that interconnects components inside a vehicle (e.g., automobile, bus, train, industrial or agricultural vehicle, ship, or aircraft). Protocols include Controller Area Network (CAN), Local Interconnect Network (LIN) and others.

CAN Bus

A Controller Area Network (CAN bus) is a robust vehicle bus standard designed to allow microcontrollers and devices to communicate with each other in applications without a host computer.

SAE International

Initially established as the Society of Automotive Engineers, is a U.S.-based, globally active professional association and standards developing organization for engineering professionals in various industries. Principal emphasis is placed on transport industries such as automotive, aerospace, and commercial vehicles.

SAE J1708

SAE J1708 is a standard used for serial communications between ECUs on a heavy duty vehicle and also between a computer and the vehicle. With respect to Open System Interconnection model (OSI), J1708 defines the physical layer. Common higher layer protocols that operate on top of J1708 are SAE J1587 and SAE J1922. The protocol is maintained by SAE International.

SAE J1939

Society of Automotive Engineers standard SAE J1939 is the vehicle bus recommended practice used for communication and diagnostics among vehicle components. It is used in the commercial vehicle area for communication throughout the vehicle, with the

physical layer defined in ISO 11898.

J1850

Defines a serial data protocol. There are two variants- 10.4 Kbit/s (single wire, VPW) and 41.6 Kbit/s (two wire, PWM). Mainly used by US manufacturers, also known as PCI (Chrysler, 10.4 Kbit/s), Class 2 (GM, 10.4 Kbit/s), and SCP (Ford, 41.6 Kbit/s).

OBD

On-board diagnostics (OBD) is an automotive term referring to a vehicle's self-diagnostic and reporting capability. OBD systems give the vehicle owner or repair technician access to the status of the various vehicle engine systems.

OBD-II diagnostic connector

The OBD-II DLC (post-1996 vehicles) is usually located under the instrument panel on the driver side, though there are several exceptions. The SAE J1962 specification provides for two standardized hardware interfaces, called type A and type B. Both are female, 9-pin (2x8), D-shaped connectors, and both have a groove between the two rows of pins.

DLC

The data link connector (DLC) is the multi-pin diagnostic connection port for automobiles, trucks, and motorcycles used to interface a scan tool with the control modules of a given vehicle and access on-board diagnostics and live data streams.

8 Data Manager

The Data Manager application allows you to store, print, and review the saved files, manage the workshop information, and customer information records, and keep test vehicle history records.

Selecting the Data Manager application opens the file system menu. There are nine main functions available.

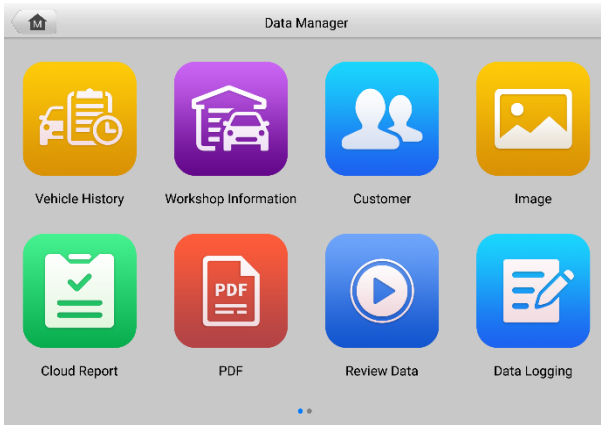











Figure 8-1 Data Manager Main Screen

The table below briefly describes each of the function buttons in the Data Manager application.

Table 8-1 Buttons in Data Manager

Button	Name	Description
	Vehicle History	Tap to review the diagnostics history record.

Button	Name	Description
	Workshop Information	Tap to edit the information of workshops.
	Customer	Tap to create new customer information.
	Image	Tap to review the screenshots.
	Cloud Report	Tap to review the saved reports and share cloud reports.
	PDF	Tap to review the reports stored as PDF files.
	Review Data	Tap to review the recorded data.
	Data Logging	Tap to review the communication data and ECU information of the vehicle. The saved data can be reported and sent to the technical center via the Internet.
	Uninstall Apps	Tap to uninstall applications.

8.1 Vehicle History

This function stores records of test vehicle history, including vehicle information and the retrieved DTCs from previous diagnostic sessions. Test information is summarized and displayed in an easy-to-read table listing. The Vehicle History also provides direct access to the previously tested vehicle and allows you to directly restart a diagnostic session without needing to perform auto or manual vehicle selection.

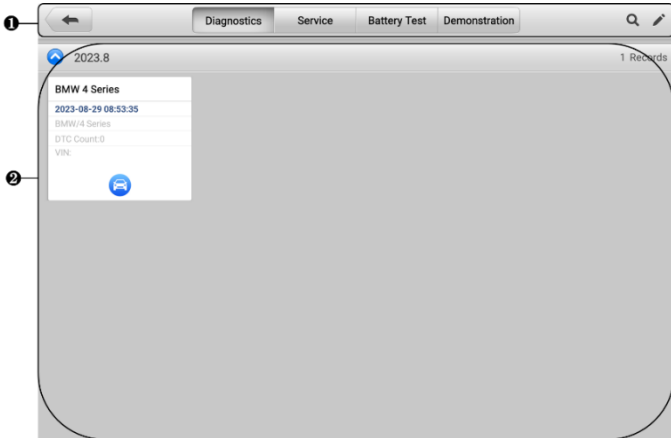


Figure 8-2 Vehicle History Screen

1. Top Toolbar Buttons — navigation and application controls.
2. Main Section — displays all the vehicle history records.
- **To activate a test session for the recorded vehicle**
 1. Tap **Data Manager** on the MaxiSys Job Menu.
 2. Select **Vehicle History** to open the screen. Tap the relevant application tab to select the test record. For example, tap **Diagnostics** to select diagnostics test records.
 3. Tap the **Diagnostics** icon at the bottom of the thumbnail of a vehicle record item.
 4. The Diagnostics screen of the vehicle displays and a new diagnostics session is activated. See [Diagnostics](#) to continue the diagnostics. Or,
 5. Select a vehicle thumbnail to open a record. A Historical Test record sheet displays. Review the recorded information of the test vehicle, and tap the **Diagnostics** button on the upper-right corner.

NOTE

The MaxiSys tablet must establish a stable connection to the VCMI device to restart test sessions on the previously tested vehicles.

8.1.1 Historical Test Record

The Historical Test Record is a detailed data form of the vehicle, which includes general vehicle information, service record, customer information, and the diagnostic trouble codes retrieved from the previous test sessions. Technician Notes will also appear if present.

Historical Test			
Title		Aston Martin Cygnet (As of 2011)	
Vehicle Information			
Year		License plate	
Make	Aston Martin	VIN	
Model	Cygnet (As of 2011)	Odometer	
Sub model		Color	Color
Engine		Status	Not started
Service record			
Technician			
Technician Notes			
Customer information			

Figure 8-3 Historical Test Record Sheet

➤ **To edit the Historical Test record**

1. Tap **Data Manager** on the MaxiSys Job Menu.
2. Select **Vehicle History**.
3. Select the specific vehicle history record thumbnail from the main section. The Historical Test record will display.
4. Tap **Edit** (a pen icon) to start editing.
5. Tap each item to input information or attach files or images.

NOTE

The vehicle VIN, license number, and customer account information are correlated by default. Vehicle records will automatically be correlated using this vehicle and customer identification.

6. Tap **Add to Customer** to correlate the Historical Test record sheet to an existing customer account, or add a new associated account to be correlated with the test vehicle record. See *Customer* for more information.
7. Tap **Done** to save the updated record, or tap **Cancel** to exit without saving.

8.2 Workshop Information

The Workshop Information form allows you to edit, input, and save the detailed workshop information, such as shop name, address, phone number, and other remarks, which, when printing vehicle diagnostic reports and other associated test file, will display as the header of the printed documents.

The screenshot shows a mobile application interface for entering workshop details. At the top, there is a back arrow and the title 'Workshop information'. Below this, the form is organized into two main sections. The first section, 'Basic information', contains two logo upload buttons labeled 'Set shop logo' and 'Logo', each with a plus sign. Below these are several text input fields: 'Shop name', 'Tel', 'State', 'Fax', 'City', 'E-mail', 'Zip code', and 'Address'. The second section, 'More information', contains four more text input fields: 'Manager name', 'Manager title', 'Website', and 'Slogan'.

Figure 8-4 Workshop Information Sheet


- **To edit the Workshop Information sheet**
 1. Tap the **Data Manager** application on the MaxiSys Job Menu.
 2. Select **Workshop Information**.
 3. Tap on each field to input the appropriate information.
 4. Tap **Done** to save the updated workshop information record, or tap **Cancel** to exit without saving.

8.3 Customer


The Customer function allows you to create and edit customer accounts. It helps you to save and organize all customer information accounts that are correlated with the associated test vehicle history records.

➤ **To create a customer account**

1. Tap the **Data Manager** application on the MaxiSys Job Menu.
2. Select **Customer**.
3. Tap the **Add a Customer** button. An empty information form displays; tap each field to input the appropriate information.

 **NOTE**

The items that must be filled are indicated as required fields.

4. Some customers may have more than one vehicle for service; you can always add new vehicle information to the account. Tap **Add New Vehicle Information**, and then fill in the vehicle information. Tap the  button to cancel.
5. Tap **Complete** to save the account, or tap **Cancel** to exit without saving.

➤ **To edit a customer account**

1. Tap **Data Manager** on the MaxiSys Job Menu.
2. Select **Customer**.
3. Select a customer account by tapping the corresponding name card. A Customer Information record displays.
4. Tap the **Edit** icon on the top toolbar to start editing.
5. Tap on the input field to edit or amend information, and enter the updated information.
6. Tap **Complete** to save the updated information, or tap **Cancel** to exit without saving.

➤ **To delete a customer account**

1. Tap **Data Manager** on the MaxiSys Job Menu.
2. Select **Customer**.
3. Tap the **Delete** icon on the right of a customer account. A message displays.
4. Tap **OK** to confirm the command, and the account is deleted, or tap **Cancel** to cancel the request.

8.4 Image

The Image section is a PNG database containing all captured screenshots.

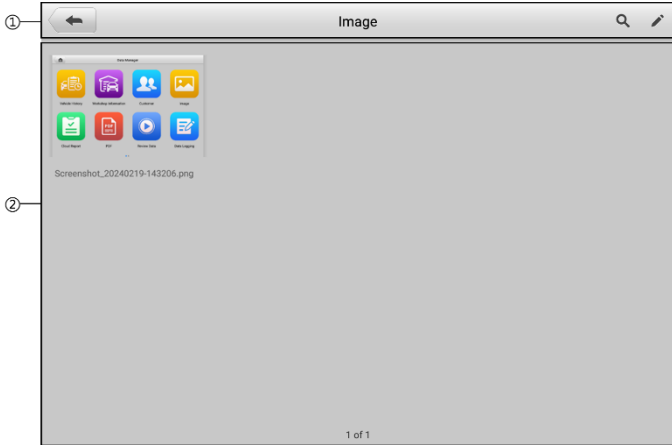









Figure 8-5 Image Database Screen

1. **Toolbar Buttons** — used to edit, print, or delete the image files. See [Table 8-2 Toolbar Buttons in PNG Database](#) for detailed information.
2. **Main Section** — displays the stored images.

Table 8-2 Toolbar Buttons in PNG Database

Button	Name	Description
	Back	Returns to the previous screen.
	Search	Tap to search the image by entering its stored time.
	Edit	Tap to display the editing toolbar to select, delete, print, or email the image(s).
	Cancel	Tap to close the editing toolbar or cancel file search.

Button	Name	Description
	Print	Tap to print the selected image.
	Delete	Tap to delete the selected image.
	Email	Tap to send the selected image to an email.

➤ **To edit/delete image(s)**

1. Select **Data Manager** from the MaxiSys Job Menu.
2. Select **Image** to access the PNG database.
3. Tap **Edit** on the top-right corner of the window. The editing screen displays.
4. Select the image(s) you want to edit by tapping the check box at the bottom-right corner of the image.
5. Tap the **Delete** icon to delete the selected images or delete all images. Tap the **Print** icon to print the selected image(s). Tap the **Email** icon to send the selected image(s) to an email.

8.5 Cloud Report

This section displays the saved reports, which can be transferred to the Autel cloud platform once a stable network connection is established. These reports can then be viewed or shared with others. See [Report Settings](#) and [Diagnostics Report Saving, Viewing, and Sharing](#) for further details.

8.6 PDF Files

The PDF files designated for local viewing are displayed in this section. Enter the PDF database and select a file to access the saved information.

This section uses the standard Adobe Reader application for file viewing and editing. Please refer to the associated Adobe Reader manual for more detailed instructions.

8.7 Review Data

The Review Data section allows you to play back the recorded data frames of live data streams.

On the Review Data main screen, select a record file to play back.

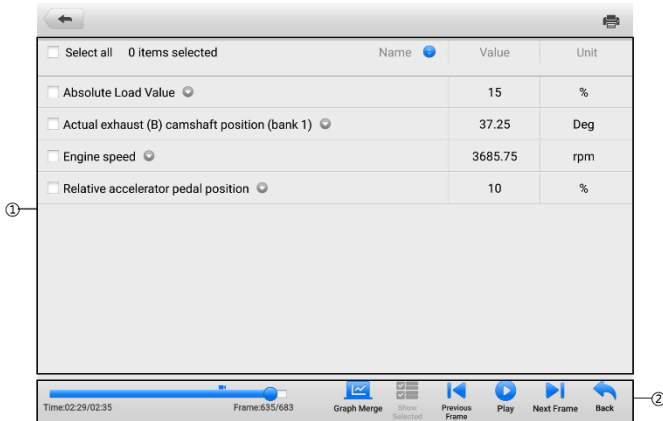


Figure 8-6 Data Playback Screen

1. Main Section — displays the recorded data frames.
2. Navigation Toolbar — allows you to manipulate data playback.

Use the Navigation Toolbar buttons to play back the record data from frame to frame.

Tap **Back** to exit data playback.

8.8 Data Logging

The Data Logging section allows you to launch Support platform directly to view all records of all feedback or no feedback data loggings on the diagnostic system. For more details, see [Data Logging](#).


8.9 Uninstall Apps

This section allows you to manage the software applications installed on the MaxiSys diagnostics system. Selecting this section opens a managing screen, on which you can check all available vehicle diagnostic applications.

Select the vehicle software you want to delete by tapping on the vehicle manufacturer icon. The selected item will display a blue mark at the upper-right corner. Tap the **Delete** button on the top toolbar to delete the software from the system database.

9 Battery Test

The Battery Test application allows the user to perform in-vehicle battery test and out-vehicle battery test functions when the BT506 battery tester is connected to the MaxiSys tablet and a battery. The BT506 battery tester enables technicians to view the health status of the vehicle's battery and electrical system.

 **NOTE**

The BT506 battery tester needs to be purchased separately.

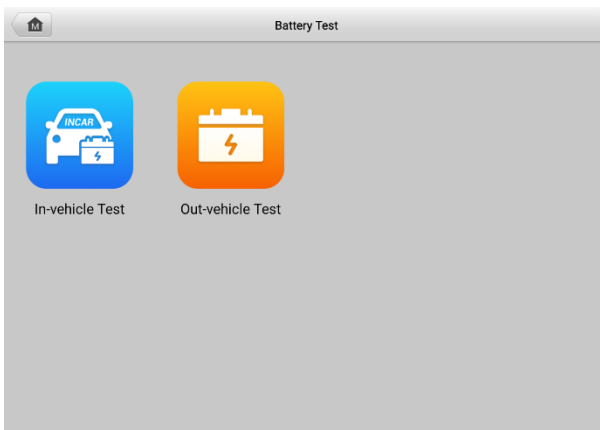


Figure 9-1 *Battery Test Screen*

9.1 MaxiBAS BT506 Battery Tester

9.1.1 Function Description

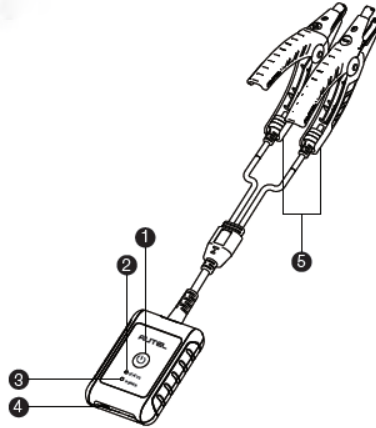


Figure 9-2 MaxiBAS BT506 Tester

- 1. Power Button
- 2. Status LED
- 3. Power LED
- 4. USB Port
- 5. Battery Clamp Cable

Table 9-1 LED Description

LED	Color	Description
Status LED	Flashing Green	The tester is communicating via USB cable.
	Flashing Blue	The tester is communicating via Bluetooth.
	Flashing Red	Battery clamps are connected to the wrong battery terminals.

LED	Color	Description
Power LED	Solid Green	The tester is powered on and the battery is sufficiently charged.
	Flashing Green	The tester is charging. (Turns solid green when battery is fully charged.)
	Solid Red	The device is in boot mode.
	Flashing Red	The battery level is low. Please charge.

9.1.2 Power Sources

The MaxiBAS BT506 tester can receive power from the following sources:

- Internal Battery Pack
- AC/DC Power Supply

! IMPORTANT

Do not charge the tester when the temperature is below 0 °C (32 °F) or above 45 °C (113 °F).

9.1.2.1 Internal Battery Pack

The MaxiBAS BT506 battery tester can be powered with the internal rechargeable battery.

9.1.2.2 AC/DC Power Supply — Using Power Adapter

The MaxiBAS BT506 battery tester can be powered from an electrical outlet using the AC/DC power adapter. The AC/DC power supply also charges the internal battery pack.

9.1.3 Technical Specifications

Table 9-2 Technical specifications

Item	Description
Connectivity	<ul style="list-style-type: none"> ● USB 2.0, Type C ● Bluetooth 4.2
Input Voltage	5 V DC
Working Current	< 150 mA at 12 V DC

Item	Description
Internal Battery	3.7 V/800 mAh Lithium-ion Polymer battery
CCA Range	100 to 2000 A
Voltage Range	1.5 to 16 V
Working Temp.	- 10 °C to 50 °C (14 °F to 122 °F)
Storage Temp.	- 20 °C to 60 °C (- 4 °F to 140 °F)
Dimension (L x W x H)	107 mm (4.21") x 75 mm (2.95") x 26 mm (1.02") (clamp cable not included)
Weight	320 g (0.7 lbs.)

9.2 Test Preparation

9.2.1 Inspect the Battery

Before starting a test, inspect the battery for:

- Cracking, buckling or leaking. If you see any of these defects, replace the battery.
- Corroded, loosen or damaged cables and connections. Repair or replace as needed.
- Corrosion on the battery terminals, and dirt or acid on the case top. Clean the case and terminals using a wire brush and a mixture of water and baking soda.

9.2.2 Connect the Battery Tester

➤ To pair with the MaxiSys tablet

1. Turn on both the MaxiSys tablet and the BT506 battery tester. Ensure that the units are sufficiently charged before you begin.
2. Enable Bluetooth on the tablet by tapping **VCMI Manager** > **BAS BT**. Tap **Scan** at the top-right corner. The device will start to search for available pairing units.
3. Depending on the type of battery tester, the device name may display as "Maxi" suffixed with a serial number. Select the appropriate device for pairing.
4. When paired successfully, the connection status will read "Connected."

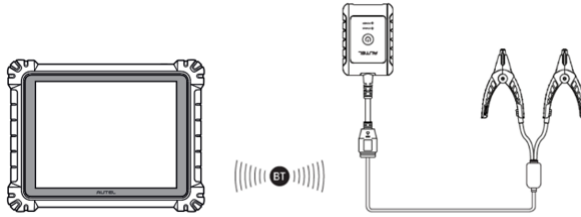


Figure 9-3 Battery Tester Connection Example 1

➤ **To connect to a battery**

1. Connect the red clamp to the positive (+) terminal of the battery.
2. Connect the black clamp to the negative (-) terminal of the battery.

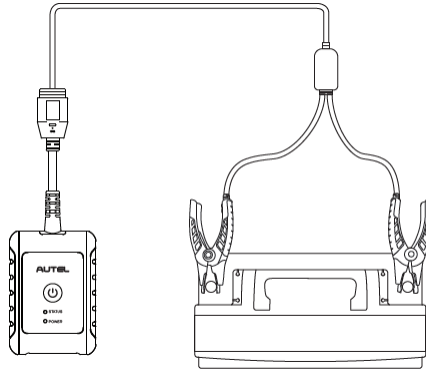


Figure 9-4 Battery Tester Connection Example 2

9.3 In-vehicle Test

The In-vehicle Test is used for testing batteries that are installed in a vehicle. An in-vehicle test includes the Battery Test, Starter Test, and Generator Test. These tests help determine the health of the battery, the starter, and the generator.

! IMPORTANT

A disclaimer will appear when first accessing any function on the Home screen. Please read the end-user agreement and tap **Accept** to continue. If you tap **Decline**, you will not be able to use the features properly.

Prior to testing any battery, ensure that the battery tester is paired with the tablet via Bluetooth and connected properly to a battery.

➤ **To start the in-vehicle test**

1. Tap **Battery Test** on the MaxiSys Job Menu. Select **In-vehicle Test**.
2. Confirm the vehicle information on the left side of the screen. Make sure the VIN is entered.
3. Confirm your battery information, including voltage, type, standard, and capacity. Tap **Next** to continue in-vehicle test functions.

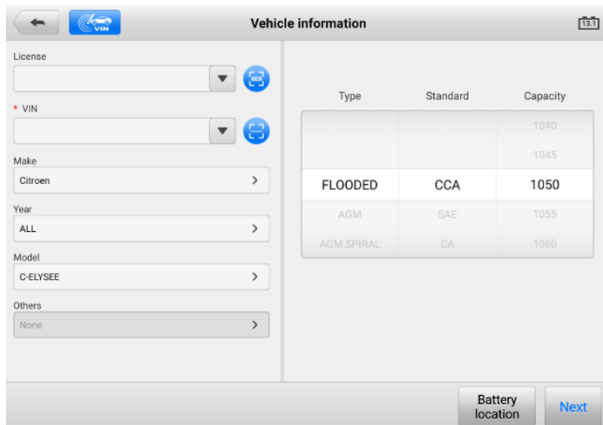




Figure 9-5 Battery information Screen




NOTE

In the Settings application, the Battery Test option allows you to change the requirement for entering the VIN information. If the setting is enabled, supplying the VIN is no longer mandatory.

Refer to the table below for a list of buttons that may appear when accessing the functions:

Table 9-3 Top Toolbar Buttons

Button	Name	Description
	Battery Connection	The value on the icon indicates the real-time voltage of the tested battery. In the battery test, the button will turn green if the battery is good; otherwise, it will turn red.
	Next	Tap to proceed.

Button	Name	Description
	Home	Returns to the battery test main screen.
	Back	Returns to the previous screen.
	Exit	Returns to the Job Menu.

9.3.1 Battery Test

1. Follow the on-screen instructions. Check the boxes once all required tasks are completed, and tap **Start Testing**.

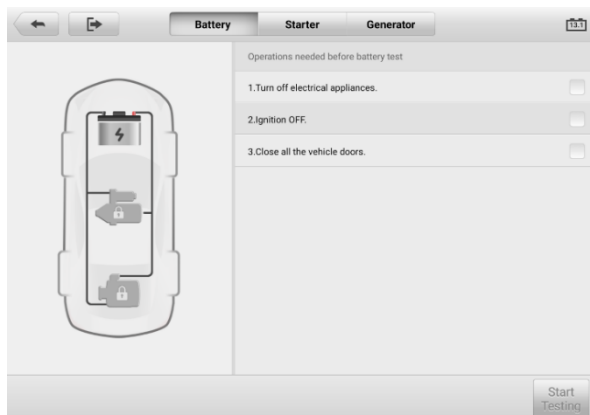


Figure 9-6 Battery Screen

2. Wait until the test is completed. The test results will be displayed on the tool.

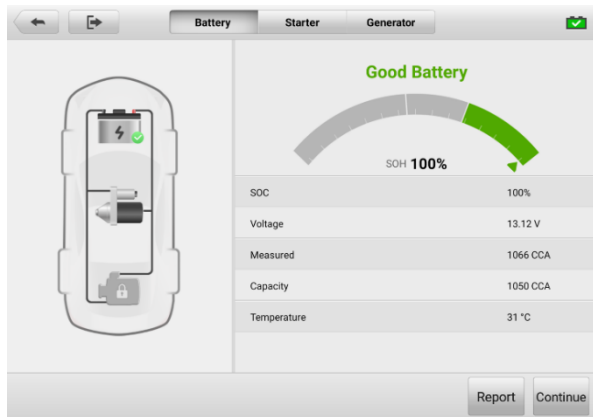


Figure 9-7 Battery Test Results Screen

Table 9-4 Test Results

Result	Description
Good Battery	Battery is good.
Good & Recharge	Battery is good but insufficiently charged. Recharge the battery.
Charge & Retest	Battery requires charge to determine its condition.
Bad Cell	Replace the battery.
Replace Battery	Replace the battery.

NOTE
Please always complete the battery test before you proceed to the starter and generator tests.

9.3.2 Starter Test

Follow the on-screen instructions to complete the test. Start the engine and let it idle. The test results will appear as follows:

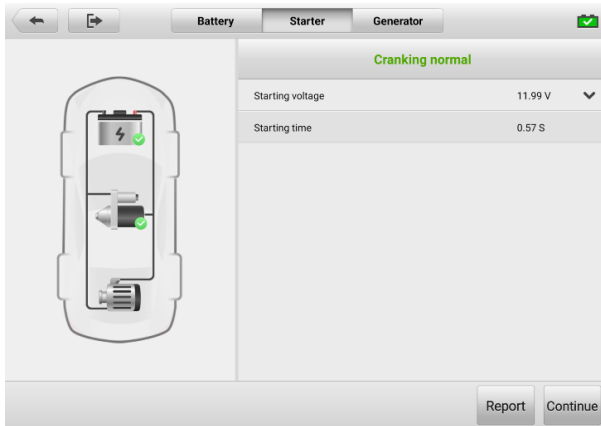


Figure 9-8 Starter Test Result Screen

Table 9-5 Starter Test Results

Result	Description
Cranking Normal	The starter is good.
Current Too Low	Low momentary discharge capacity.
Voltage Too Low	Low battery storage capacity.
Not Started	The starter is not detected for starting.

9.3.3 Generator Test

Follow the on-screen instructions to complete the test. The test results will appear as follows:

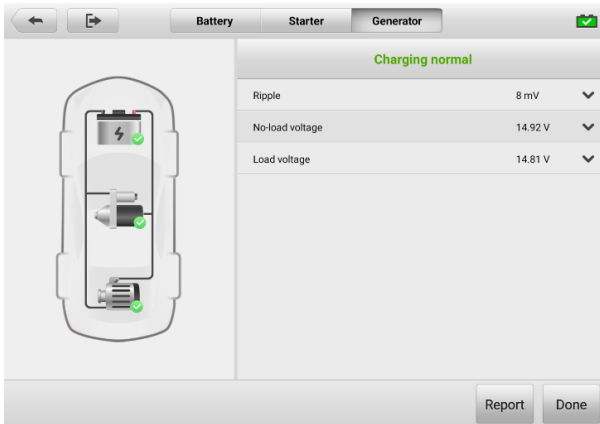


Figure 9-9 Generator Test Results Screen

Table 9-6 Generator Test Results

Result	Description
Charging Normal	The generator is functioning normally.
Output Too Low	<ul style="list-style-type: none"> The belt linking the starter and the generator is loose; The cable linking the starter and battery is loose or corroded.
Output Too High	<ul style="list-style-type: none"> The generator is not properly connected to the ground; The voltage adjuster is broken and needs replacement.
Ripple Too Large	The commutation diode is broken.
No Output	<ul style="list-style-type: none"> The cable is loose; Some vehicles with power management systems do not provide path for charging due to the sufficient load capacity of the battery; The generator or the voltage adjuster is broken and needs replacement.

9.4 Out-vehicle Test

Out-vehicle Test is used to test the condition of batteries that are not connected to a vehicle. This function aims to check the health status of the battery only.

9.4.1 Test Procedure

➤ **To start the out-vehicle test**

1. Connect the tester clamps to the battery terminals.
2. Tap **Battery Test** on the MaxiSys Job Menu. Select **Out-vehicle Test**.
3. Select the appropriate battery type, rating standard, and CCA value. Tap **Start Testing** to start the test.

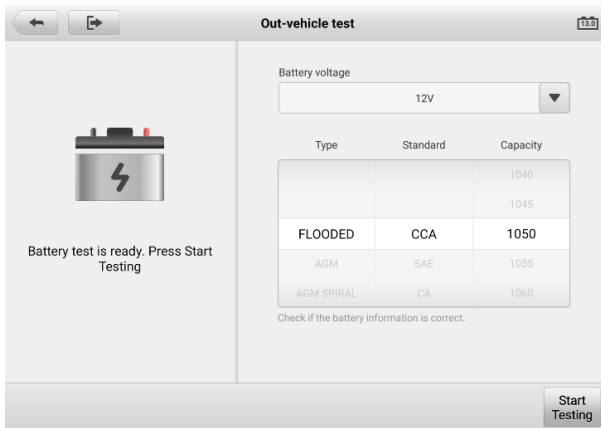


Figure 9-10 Out-vehicle Test Screen

4. The test results will display in a few seconds.

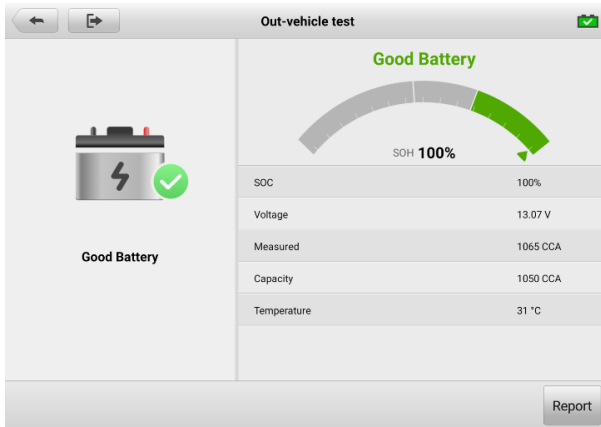


Figure 9-11 Out-vehicle Test Results Screen

9.4.2 Test Results

Table 9-7 Out-Vehicle Test Results

Result	Description
Good Battery	Battery meets required standards.
Good & Recharge	Battery is good, but low on charge. Fully charge the battery. Check for causes of low charge.
Charge & Retest	Battery requires charge to determine its condition.
Replace Battery	Battery fails to meet industry-accepted standards.
Bad Cell	Battery fails to meet industry-accepted standards.

10 Settings

Access the Settings menu to adjust default setting and view information about the MaxiSys system. The following options are available for the MaxiSys system settings:

- Unit
- Language
- Printing Settings
- Report Settings
- Push Notification
- Auto Update
- ADAS Settings
- Vehicle List
- EVDiag Box Settings
- AutoVID Setup
- Country/Region Code
- System Settings
- About

10.1 Unit

This option allows you to change the measurement unit for the diagnostic system.

➤ To adjust the unit setting

1. Tap the **Settings** application on the MaxiSys Job Menu.
2. Tap the **Unit** option on the left column.
3. Select the appropriate measurement unit. A check mark will display to the right of the selected unit.
4. Tap the **Home** button on the top-left corner to return to the MaxiSys Job Menu, or select another settings option for system setup.

10.2 Language

This option allows you to adjust the display language for the MaxiSys system.

➤ **To adjust the language setting**

1. Tap the **Settings** application on the MaxiSys Job Menu.
2. Tap the **Language** option on the left column.
3. Select the appropriate language. A check mark will display to the right of the selected language.
4. Tap the **Home** button on the top-left corner to return to the MaxiSys Job Menu, or select another settings option for system setup.

10.3 Print Settings

This option allows you to print from the tablet to a network printer via a computer.

➤ **To setup the printer connection**

1. Tap **Settings** on the MaxiSys Job Menu.
2. Tap **Printing Settings** on the left column.
3. Tap **Print via PC-link** or **Print via Wi-Fi** to activate the printing function, which enables the device to send files to the printer through the PC via Wi-Fi or Ethernet connection.
4. Tap the **Home** button on the top-left corner to return to the MaxiSys Job Menu, or select another settings option for system setup.

10.3.1 Printing Operations

➤ **To install the MaxiSys Printer driver**

1. Download **Maxi PC Suite** from www.autel.com > Support > Downloads > Autel Update Tools, and install it to a Windows-based PC.
2. Double click on **Setup.exe**.
3. Select the installation language and the wizard will load.
4. Follow the instructions on the screen and Click on **Next** to continue.
5. Click **Install** and the printer driver program will be installed onto the computer.
6. Click **Finish** to complete the installation.

 **NOTE**

The MaxiSys printer runs automatically after the installation. The PC, printer and the tablet must be connected to the same network.

This section describes how to receive file from the MaxiSys tablet and perform printing through the PC.

 **NOTE**

1. Make sure the tablet is connected to the same network with your computer, either via Wi-Fi or LAN, before printing.
 2. Make sure the computer installed with the Printing Services program is connected to a printer.
-

➤ **To perform printing through the computer**

1. Ensure the tablet is connected to the computer network, either via Wi-Fi or LAN, before printing.
 2. Run the **PC Link** program on the computer.
 3. Select the **MaxiSys Printer** tab.
 4. Tap the **Print** button in the tablet top toolbar. A document will be sent to the computer.
 - If the **Auto Print** option in the MaxiSys Printer is selected, the MaxiSys Printer will print the received document automatically.
 - If the **Auto Print** option is not selected, click **Open PDF File** button to view files. Select the file(s) to print and click **Print**.
-

 **NOTE**

To confirm that the printer is functioning normally, you can click **Test Print** in the PC Link program to test.

10.4 Report Settings

Toggle the **ON/OFF** button to enable/disable Report Upload to Cloud function. If the button displays blue, it indicates the Report Upload to Cloud function is enabled. If the button displays gray, it indicates the Report Upload to Cloud function is disabled.

10.5 Push Notification

This option allows you to manage notifications. The Notification Preference is turned on by default and cannot be turned off by users so that certain system notifications such as system security warnings won't be blocked. Internet access is required for receiving on-line messages.

➤ **To manage other notifications**

1. Tap **Settings** on the MaxiSys Job Menu.
2. Tap **Push Notifications** on the left column.
3. Tap the ▼ button on the right to open a drop-down list.
4. There are four options: Enable all notifications, Limit to 3 notifications or less per week, Limit to 1 notification per week, and Disable all notifications. Select whichever you want.
5. Tap **Home** on the top-left corner to return to the MaxiSys Job Menu. Or select another settings option for the system setup.

🔗 **NOTE**

3. Notifications will display on the screen. Slide the screen from top to check the received messages. If the message list covers more than one screen, slide the list up or down to view them.
 4. Tapping a specific message launches the corresponding application. For example, if you tap on an Update notification, the Update application will be launched.
-

10.6 Auto Update

The Auto Update allows the tool to automatically update the OS, the MaxiSys system, and the vehicle coverage software. Each can be configured to update automatically at a specified time. Tap the **ON/OFF** button to enable/disable the desired automatic update time.

➤ **To set auto system or vehicle update**

1. Tap the **Settings** application on the MaxiSys Job Menu.
2. Tap the **Auto Update** option on the left column. The three auto update items will display on the right of the screen.
3. Select the update type to schedule. Toggle the button to **ON**.
4. Tap on the time to set the time of the day for updating. If the update time is set and the device is connected to the Internet, the selected software will be automatically updated at the configured time.

10.7 ADAS Settings

➤ **To activate the MaxiSys ADAS calibration**

1. Confirm the registered MaxiSys tablet has available updates.
2. Select **Settings** on the MaxiSys Job Menu.
3. Tap on **ADAS Settings**.

4. Scan the QR code on the ADAS frame to bind, or manually input frame serial number when QR code is not available.
5. Enter the validation code from the ADAS Calibration Card.
6. The system will be reset and the Job Menu will display once the registration has been completed.

10.8 Vehicle List

This option allows you to sort the vehicles either by alphabetic order or by frequency of use.

➤ **To adjust the vehicle list setting**

1. Tap the **Settings** application on the MaxiSys Job Menu.
2. Tap **Vehicle List** on the left column.
3. Select the required sort type. A check mark will display to the right of the selected item.
4. Tap the **Home** button in the top-left corner to return to the MaxiSys Job Menu, or select another settings option for system setup.

10.9 EVDiag Box Settings

When the EVDiag Box device is linked with the tablet, this MaxiSys diagnostics system can support the battery pack test function.

➤ **To link the EVDiag Box device**

1. Tap the **Settings** application on the MaxiSys Job Menu.
2. Tap the **EVDiag Box Settings** option on the left column.
3. Connect the EVDiag Box according to the on-screen connection diagram.
4. Tap **Read** to automatically acquire the EVDiag Box serial number and tap **Link EVDiag Box**.
5. Restart your tablet to automatically download the Battery Pack Test software.

10.10 AutoVID Setup

This option allows you to enable/disable the automatic vehicle VIN reading function. When this function is active, the tablet will read the vehicle VIN via the communication methods you enabled after the VCI is connected to the vehicle.

10.11 Country/Region Code

This function provides Wi-Fi channel options for different country regions to ensure reliable and stable Wi-Fi communication. Please connect the tablet with VCMI device before making adjustment.

➤ **To adjust the country code setting**

1. Tap the **Settings** application on the MaxiSys Job Menu.
2. Tap the **Country/Region Code** option on the left column.
3. Select the appropriate country/region. A confirmation message will display.
4. Tap the **Home** button on the top-left corner to return to the MaxiSys Job Menu, or select another settings option for the system setup.

 **NOTE**

If the tablet cannot find the VCMI device via Wi-Fi connection after setting the country code, please connect the VCMI with tablet via USB cable or Bluetooth connection to retry.

10.12 System Settings

This function provides you with direct access to the Android system setting interface, where you can adjust various system settings for the Android system platform. Regarding wireless and networks settings, various device settings such as sound and display, as well as system security settings, and check related information about the Android system. Refer to Android documentation for additional information.

10.13 About

The About function provides information of the MaxiSys diagnostic device including the product name, version, hardware, and serial number.

➤ **To check the MaxiSys product information in About**

1. Tap the **Settings** application on the MaxiSys Job Menu.
2. Tap the **About** option on the left column. The product information screen displays on the right.
3. Tap the **Home** button on the top-left corner to return to the MaxiSys Job Menu, or select another settings option for system setup.

11 Update



The Update application on the tablet downloads the latest version of the software. The updates improve the MaxiSys applications' capabilities, typically by adding new tests, new model coverage or by adding new or enhanced applications.

The tablet automatically searches for available updates for all of the MaxiSys software when it is connected to the Internet. Any updates that are found can be downloaded and installed on the device. This section describes update procedures in the MaxiSys system.

NOTE

Ensure the tablet is registered before utilizing the Update application. See [Autel User Center](#) for a comprehensive registration guide.

To update the software

1. Power up the tablet, and ensure that it is connected to a power source and has a steady Internet connection.
2. Tap the **Update** application button from the MaxiSys Job Menu. The Update application screen displays.
3. On the Update screen, tap the **Get** button to update the specific item(s) or tap the **Update All** button to update all available items.
4. Tap **More** to view the details of all the available updates. You can also tap the **Get** or **Update All** button for update.
5. During the update, tap the  icon to suspend the updating process. Tap the  icon to resume the update and the process will continue from the pause point.
6. When the updating process is completed, the software will be installed automatically. The new version will replace the older version.

NOTE

For the account management, proceed to the Member Center tab.

12 VCMi Manager

The VCMi Manager is an application for connecting the MaxiSys tablet with VCMi. This application allows you to pair the tablet with the VCMi and to check the communication status. You can either build the connection via the Bluetooth or Wi-Fi, of which the latter is more stable and faster in speed for module operation.

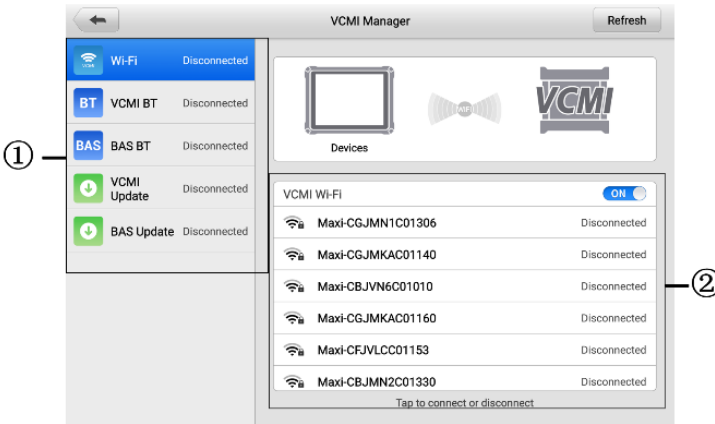


Figure 12-1 VCMi Manager Screen

1. **Connection Mode:** five connection modes are available. The connection status displays adjacent to each mode.
 - Wi-Fi Connection — when connected to a wireless device, the connection state displays as “Connected.” Otherwise, it displays as “Disconnected.”
 - VCMi Bluetooth Pairing — when the VCMi is paired to the tablet via Bluetooth, the connection status displays as “Connected.” Otherwise, it displays as “Disconnected.”
 - BAS Bluetooth Pairing— when paired to a battery tester via Bluetooth, the connection status displays as “Connected.” Otherwise, it displays as “Disconnected.”
 - VCMi Update — connects the VCMi to the diagnostic tablet, then updates the VCMi firmware through the tablet.
 - BAS Update — connects the battery tester to the diagnostic tablet, then updates the battery tester’s firmware through the tablet.

2. **Settings:** this section allows you to manage wireless pairing or set up network connection. Toggle the **ON/OFF** button to **ON**. The available devices for pairing will display. Tap the needed one to start pairing.

12.1 Wi-Fi Connection

Wi-Fi Connection is an advanced function for quick linkage with VCMI. Since Wi-Fi connection supports 5G, the MaxiSys tablet and VCMI share a faster and more stable connection when using this communication method. The tablet can be operated up to 50 meters away from the VCMI device when connected to the vehicle.

The Wi-Fi connection is an ideal communication mode when using the oscilloscope measurement function. See [Oscilloscope](#) for details.

➤ **To connect the VCMI to the tablet via Wi-Fi**

1. Power on the tablet.
2. Connect the 26-pin end of the main cable to the VCMI's vehicle data connector.
3. Connect the 16-pin end of the main cable to the vehicle data link connector (DLC).
4. Tap **VCMI Manager** on the MaxiSys Job Menu of the tablet.
5. Select **Wi-Fi** from the connection mode list.
6. Swipe the Wi-Fi toggle button to **ON**. Tap **Refresh** at the top-right corner. The device will start to search for available units.
7. Depending on the VCMI type you use, the device name may display as "Maxi" suffixed with a serial number. Select the appropriate device for connection.
8. When the connection is established, the connection status displays as "Connected".
9. The VCMI button on the system navigation bar at the bottom of the screen displays a green Wi-Fi icon, indicating the tablet is connected to the VCMI device.
10. Tap the connected device again to disconnect the device.
11. Tap **Back** on the top-left corner to return to the MaxiSys Job Menu.

 **NOTE**

To ensure a quick connection, please connect in a steady network environment.

12.2 VCMI Bluetooth Pairing

Bluetooth Pairing is the basic way for wireless connection. The VCMI device needs to be either connected to a vehicle or to an available power source, so that it is powered up during the synchronization procedure. Make sure the tablet has a charged battery or is connected to an AC/DC power supply.

➤ **To pair the VCMI device with the tablet**

1. Power on the tablet.
2. Connect the 26-pin end of the main cable to the VCMI's vehicle data connector.
3. Connect the 16-pin end of the main cable to the vehicle data link connector (DLC).
4. Tap **VCMI Manager** on the MaxiSys Job Menu of the tablet.
5. Select **VCMI BT** from the connection mode list.
6. Swipe the Bluetooth toggle button to **ON**. Tap **Scan** at the top-right corner. The device will start to search for available pairing units.
7. Depending on the VCMI type you use, the device name may display as "Maxi" suffixed with a serial number. Select the appropriate device for pairing.
8. When paired successfully, the connection status displays as "Connected."
9. Wait a few seconds, and the VCMI button on the system navigation bar at the bottom of the screen will display a green BT icon, indicating the tablet is connected to the VCMI device.
10. Tap the connected device again to disconnect the device.
11. Tap **Back** on the top left to return to the MaxiSys Job Menu.

 **NOTE**

A VCMI device can be paired to only one tablet at a time, and once it's been paired, the device will not be discoverable for any other unit.

12.3 BAS Bluetooth Pairing

The BT506 battery tester device can be connected with the tablet via Bluetooth. Ensure that the BT506 battery tester is sufficiently charged or is connected to the external power supply before use.

➤ **To pair the Battery Tester with the tablet**

1. Power on the tablet and the battery tester.
2. Tap **VCMI Manager** on the MaxiSys Job Menu of the tablet.
3. Select **BAS BT** from the connection mode list.
4. Swipe the Bluetooth toggle button to **ON**. Tap **Scan** at the top-right corner of the screen. The device will start to search for available units to pair with.
5. Depending on the type of battery tester, the device name may appear as "Maxi" suffixed with the battery test's serial number. Select the appropriate device for pairing.
6. When paired successfully, the connection status reads "Connected."

12.4 VCMI Update

VCMI Update provides the latest update for the connected VCMI device. Before updating the VCMI firmware, make sure the tablet network is stable, and do not leave the VCMI Update page during upgrade.

➤ **To update the VCMI firmware**


1. Power on the tablet.
2. Connect the VCMI device to the tablet via USB cable.
3. Tap **VCMI Manager** on the MaxiSys Job Menu of the tablet.
4. Select **VCMI Update** from the connection mode list.
5. If the installed version is not the latest one, the current version and the latest version will display on the screen after a few seconds. Tap **Update Now** to update the VCMI firmware if available.

12.5 BAS Update

Before updating the battery tester firmware, please make sure the network connection is stable.

➤ **To update the battery tester firmware**

1. Power on the tablet and the battery tester.
2. Connect the battery tester to the tablet via Bluetooth or USB cable.
3. Tap the **VCMi Manager** application on the MaxiSys Job Menu of the tablet.
4. Select **BAS Update** from the connection mode list.
5. If the installed version is not the latest one, the current version and the latest version will display on the screen after a few seconds. Tap **Update Now** to update the BAS firmware if available.

 **NOTE**

Do not leave the BAS Update page during upgrade.

13 Support

This application launches the Support platform which synchronizes Autel's online service base station with the MaxiSys tablet. Connected to Autel's service channel and online communities, the Support application provides the quickest way for problem solutions, allowing you to send help requests to obtain direct service and support.

13.1 Support Screen Layout

The Support application interface is navigated by the Home button on the top toolbar. And the main section of the Support screen is divided into two sections. The narrow column on the left is the main menu; select one subject from the main menu to display the corresponding function screen on the right.

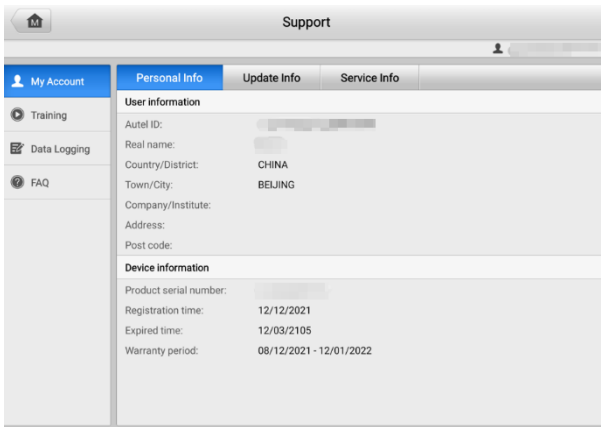


Figure 13-1 Support Application Screen

13.2 My Account

The My Account screen displays the comprehensive information of the user and the product, which is synchronized with the online registered account, including Personal Information, Update Information, and Service Information.

13.2.1 Personal Information

The User Information and Device Information are both included under the Personal Information section.

- User Information — displays detailed information of your registered online Autel account, such as your Autel ID, name, address, and other contact information.
- Device Information — displays the registered product information, including the product serial number, registration time, expired time, and warranty period.

13.2.2 Update Information

The Update Information section displays a detailed list of the product's software update history, including the product serial number, software version or name, and the update time.

13.2.3 Service Information

The Service Information section displays a detailed record list of the device's service history information. Every time the device has been sent back to Autel for repair, the device's serial number and other information, such as the fault type, changed components, or system reinstallation will be recorded and updated to the associated online product account that will be synchronized to the Service Information section.

13.3 Training

The Training section provides quick links to Autel's online video accounts. Select a video channel by language to see all available Autel online tutorial videos on such topics as product usage techniques and vehicle diagnostics practices.

13.4 Data Logging

The Data Logging section keeps records of all **Feedback** (submitted), **No feedback** (not submitted but saved) or **History** (up to the latest 20 test records) data loggings on the diagnostic system. The support personnel will receive and process the submitted reports through the Support platform. The solution will be sent back as soon as possible. You may continue to correspond with the Support platform until the issue is resolved.

➤ **To make a reply in a Data Logging session**

1. Tap on the **Feedback** tag to view the list of submitted data loggings.
2. Select a specific item to view the latest update of the processing progress.
3. Tap on the input field on the bottom of the screen and enter your reply, or tap the **Audio** button to record a voice message, or tap the **Camera** button to take a screenshot.
4. Tap **Send** to deliver your message to Autel Support.

13.5 FAQ

The FAQ section provides comprehensive references for all questions frequently asked and answered about the use of Autel's online member account and shopping and payment procedures.

- Account — displays questions and answers about the use of Autel's online user account.
- Shopping — displays questions and answers about online product purchase methods or procedures.
- Payment — displays questions and answers about online product payment methods or procedures.

14 MaxiViewer

The MaxiViewer application allows you to search the functions supported by our tools and the version information. There are two ways for searching, either by searching the tool and the vehicle or searching the functions.

➤ **To search by the vehicle**

1. Tap the **MaxiViewer** application on the MaxiSys Job Menu. The MaxiViewer application screen displays.
2. Tap the tool name on the top-left corner to drop down the tool list. Tap the one you want to search.
3. Tap the vehicle brand, model, and year you want to search.

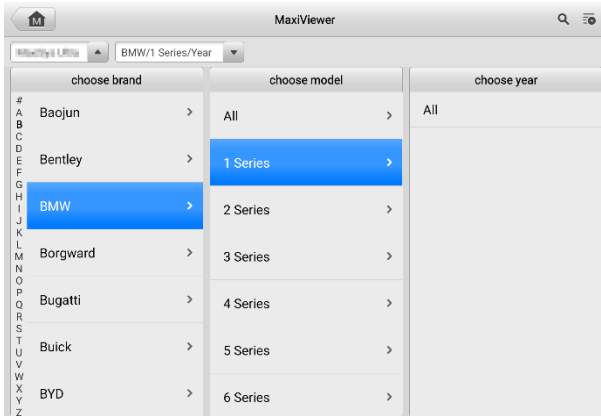


Figure 14-1 MaxiViewer Screen 1

4. All the functions supported by the selected tool for the selected vehicle display as several columns.

Year	System	Engine	Chassis	Function	Sub function	Version
/	Body	B37	F20	Service	- Newly address the air distribution flap	Above BM W_V12.00
/	Body	B37	F21	Service	- Newly address the air distribution flap	Above BM W_V12.00
/	Body	B38	F52	Service	- Newly address the air distribution flap	Above BM W_V12.00
/	Body	B47	F20	Service	- Newly address the air distribution flap	Above BM W_V12.00
/	Body	B47	F21	Service	- Newly address the air distribution flap	Above BM W_V12.00
/	Body	B58	F20	Service	- Newly address the air distribution flap	Above BM W_V12.00
/	Body	B58	F21	Service	- Newly address the air distribution flap	Above BM W_V12.00

Figure 14-2 MaxiViewer Screen 2

➤ **To search by the functions**

1. Tap the **MaxiViewer** application on the MaxiSys Job Menu. The MaxiViewer application screen displays.
2. Tap the tool name on the top-left corner to drop down the tool list. Tap the one you want to search.
3. Enter the function you want to search in the top-right search box. The screen will display all vehicles that support this function, along with information such as the vehicles' year, system, function, sub-function, and version.

Model	Year	System	Engine	Chassis	Function	Sub function	Version
1 Series	/	EPS (Electric Power Steering)	/	E81	ECU information	/	Above BMW_V1 2.00
1 Series	/	EPS (Electric Power Steering)	/	E82	ECU information	/	Above BMW_V1 2.00
1 Series	/	EPS (Electric Power Steering)	/	E87	ECU information	/	Above BMW_V1 2.00
1 Series	/	EPS (Electric Power Steering)	/	E88	ECU information	/	Above BMW_V1 2.00
1 Series	/	EPS (Electric Power Steering)	/	F20	ECU information	/	Above BMW_V1 2.00
1 Series	/	EPS (Electric Power Steering)	/	F21	ECU information	/	Above BMW_V1 2.00
1 Series	/	EPS (Electric Power Steering)	/	F52	ECU information	/	Above BMW_V1 2.00


Figure 14-3 MaxiViewer Screen 3

 **NOTE**

Fuzzy search is supported. Type in some part of the function-related keywords to find all the available information.

15 MaxiVideo

The MaxiVideo application configures the MaxiSys tablet to operate as a digital video scope by simply connecting the tablet to a MaxiVideo Digital Inspection Camera. This function allows you to examine difficult-to-reach areas normally hidden from sight, with the ability to record digital still images and videos, which offers you an economical solution to inspect machinery, facilities, and infrastructure in a safe and quick way.

 **NOTE**

1. The MaxiVideo Digital Inspection Camera and its fittings are additional accessories, and need to be purchased separately. Both sizes (8.5 mm and 5.5 mm) of the imager head are optional and available for purchase.
 2. This function is compatible with the MaxiVideo Digital Inspection Camera in models MV105S, MV108S, MV105, and MV108.
 3. Connect the tablet with MaxiVideo Digital Inspection Camera using the USB cable. For detailed operation instructions, please refer to the Quick Reference Guide for the MaxiVideo Digital Inspection Camera.
-

16 Quick Link

The Quick Link application provides you with convenient access to Autel's official website and many other well-known sites in automotive service industry to provide technical help, knowledge bases, forums, and training and expertise consultations.

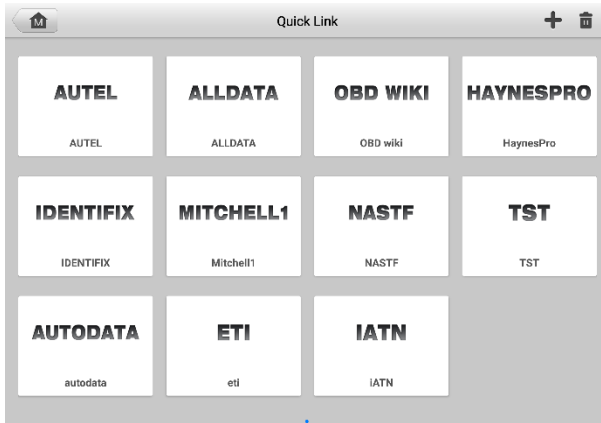


Figure 16-1 Quick Link Screen

- **To open a quick link**
 1. Tap **Quick Link** on the MaxiSys Job Menu. The Quick Link application screen displays.
 2. Select a website thumbnail from the main section. The Chrome browser is launched and the selected website is opened.
- **To manage the quick links**
 1. Tap **Quick Link** on the MaxiSys Job Menu. The Quick Link application screen displays.
 2. Tap the **+** icon on the upper-right corner to add websites. Tap the **🗑️** icon to delete websites.

17 Remote Desktop

The Remote Desktop application launches the TeamViewer Quick Support program, which is a simple, fast and secure remote-control interface. You can use the application to receive ad-hoc remote support from Autel's support center, colleagues, or friends, by allowing them to control your MaxiSys tablet on their PC via the TeamViewer software.

17.1 Operations

If you think of a TeamViewer connection as a phone call, the TeamViewer ID would be the phone number under which all TeamViewer Clients can be reached separately. Computers and mobile devices that run TeamViewer are identified by a globally unique ID. The first time the Remote Desktop application is started, this ID is generated automatically based on the hardware characteristics and will not change.

Make sure the tablet is connected to the Internet before launching the Remote Desktop application, so that the tablet is able to receive remote support from the third party.

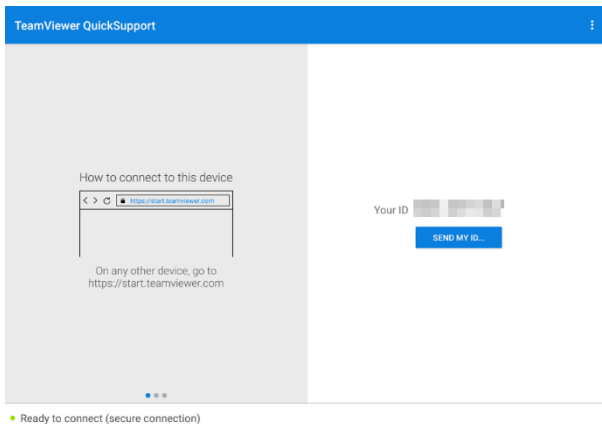


Figure 17-1 Remote Desktop Screen

➤ **To receive remote support from a partner**

1. Power on the tablet.
2. Tap the **Remote Desktop** application on the MaxiSys Job Menu. The TeamViewer interface displays and the device ID is generated and shown.
3. Your partner must install the Remote Control software to his/her computer by downloading the TeamViewer full version program online (<http://www.teamviewer.com>), and then launch the software.
4. Provide your ID to the partner, and wait for him/her to send you a remote-control request.
5. A message will appear asking for your confirmation to allow remote-control on your device.
6. Tap **Allow** to accept, or tap **Deny** to reject.

Refer to the associated TeamViewer documents for additional information.

18 User Feedback

The User Feedback application allows you to submit questions related to this product.

➤ **To send user feedback**

1. Tap **User Feedback** on the MaxiSys Job Menu. The device information is automatically synchronized.

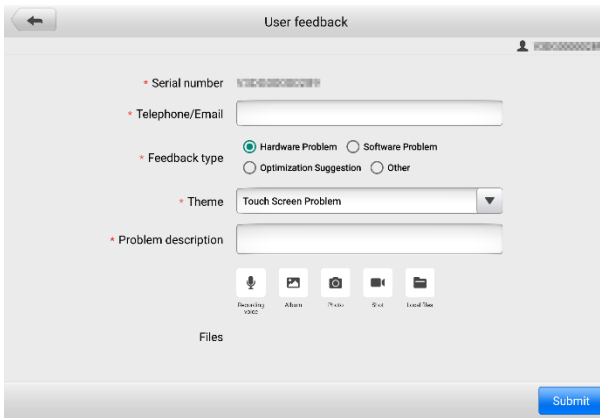


Figure 18-1 User Feedback Screen

2. Set **Telephone/Email**, **Feedback type**, **Theme**, and **Problem description**. You can also attach voice recordings, photos, screenshots, images or PDF files. To resolve your issue more efficiently, we recommend you to complete the information as many details as possible.
3. Tap **Submit** to send the completed information to Autel's online service center. The submitted feedback will be carefully read and handled by our service personnel.

19 Autel User Center

Software updates are available for free for the first year from the date of purchase. The Autel User Center application allows you to register your tool to download the latest released software, thereby enhancing the functionality of the MaxiSys application by adding new vehicle models or enhanced applications to the database.

There are two ways for product registration:

A. Via the MaxiSys tablet

➤ To log in with your account and register your Autel tool

1. Tap **Autel User Center** from the MaxiSys Job Menu. The following screen displays.

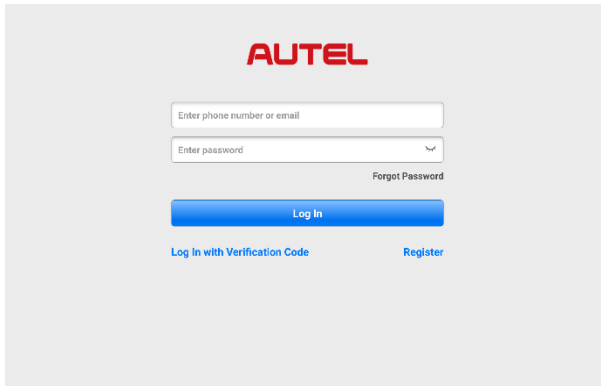


Figure 19-1 Autel User Center Screen

2. If you already have an Autel ID, you can log in with your phone number and verification code, or tap **Log In with Password** to log in with your Autel ID and password. If you don't have an Autel ID yet, tap **Register** to create an Autel ID.
3. Once your account is successfully registered, you will enter the main menu of the Autel User Center.
4. Select **Device Management** on the main menu.
5. Tap the **Link Device** button on the upper-right corner of the Device Management screen. The serial number and password of the device will automatically appear on the Link Device screen.

6. Tap the **Link** button to complete the product registration.

B. Via the Autel website

➤ **To register your Autel tool**

1. Visit the website: pro.autel.com.
2. If you have an Autel account, sign in with your account ID and password and skip to step 7.
3. If you are a new member to Autel, click the **Register** button to create your Autel ID.
4. Enter the required personal information in the input fields.
5. Enter your email address, then click **Request**. You will receive an email from Autel with your verification code. Open the email and copy the code into the proper input box.
6. Set a password for your account, and enter the password again to confirm. Read the **Autel User Service Agreement** and **Autel Privacy Policy**, then check the box to accept the terms. After all the information is entered, click **Register**. A Product Registration screen will appear.
7. Your product serial number and password are required to complete your registration. To find your serial number and password on the tool: go to **Settings > About**.
8. Enter your tool's serial number and password on the Product Registration screen. Enter the CAPTCHA code and click **Submit** to complete your registration procedure.

20 Maintenance and Service

To ensure that the tablet and the combined VCMI unit perform at their optimum level, we advise that the product maintenance instructions covered in this section are strictly followed.

20.1 Maintenance Instructions

The following includes how to maintain your devices, together with precautions to take.

- Use a soft cloth and alcohol or a mild window cleaner to clean the touchscreen of the tablet.
- Do not use any abrasive cleansers, detergent, or automotive chemicals to the tablet.
- Keep the devices in dry conditions and within specified operating temperatures.
- Dry your hands before using the tablet. The touch screen of the tablet may not work if the touch screen is moist, or if you tap the touch screen with wet hands.
- Do not store the devices in humid, dusty or dirty areas.
- Check the housing, wiring, and connectors for dirt and damage before and after each use.
- Check the housing, wiring, and connectors for dirt and damage before and after each use.
- Do not attempt to disassemble your tablet or the VCMI unit.
- Do not drop or cause severe impact to the devices.
- Use only authorized battery chargers and accessories. Any malfunction or damage caused by the use of unauthorized battery charger and accessories will void the limited product warranty.
- Ensure that the battery charger does not come in contact with conductive objects.
- Do not use the tablet beside microwave ovens, cordless phones and some medical or scientific instruments to prevent signal interference.

20.2 Troubleshooting Checklist

A. When the tablet does not work properly:

- Make sure the tablet has been registered online.
- Make sure the system software and diagnostic application software are properly updated.
- Make sure the tablet is connected to the Internet.
- Check all cables, connections, and indicators to see if the signal is being received.

B. When battery life is shorter than usual:

- This may happen when you are in an area with low signal strength. Turn off your device if it is not in use.

C. When you cannot turn on the tablet:

- Make sure the tablet is connected to a power source or the battery is charged.

D. When you are unable to charge the tablet:

- Your charger maybe out of order. Contact your nearest dealer.
- You may be attempting to use the device in an overly hot/cold temperature. Charge the device in a cooler or warmer area.
- Your device may have not been connected to the charger properly. Check the connector.

NOTE

If the problems persist, please contact Autel's technical support personnel or your local selling agent.

20.3 About Battery Usage

Your tablet is powered by a built-in lithium-ion polymer battery, which enables you to recharge your battery when there is electricity left.

DANGER

The built-in Lithium-ion Polymer battery is factory replaceable only; incorrect replacement or tampering with the battery pack may cause an explosion.

- Do not use a damaged battery charger.
- Do not disassemble, open, crush, bend, deform, puncture, or shred the battery.
- Do not modify, remanufacture or attempt to insert foreign objects into the battery, or expose the battery to fire, explosion, or other hazards.
- Only use the specified charger and USB cables. Use of non-Autel-authorized charger or USB cables may lead to device malfunction or failure.
- Use of an unqualified battery or charger may present a risk of fire, explosion, leakage, or other hazards.
- Avoid dropping the tablet. If the tablet is dropped, especially on a hard surface, and you suspect damage, take the tablet to a service center for inspection.
- Try to keep closer to your wireless router to reduce battery usage.
- The time needed to recharge the battery varies depending on the remaining battery capacity.
- Battery life inevitably shortens over time.
- Unplug the charger once the tablet is fully charged since overcharging may shorten battery life.
- Keep the battery in temperate environments. Do not place it inside a car when it is too hot or too cold, which may reduce the capacity and life of the battery.

20.4 Service Procedures

This section provides information on technical support, repair service, and application for replacement or optional parts.

20.4.1 Technical Support

If you have any question or problem on the operation of the product, please contact us.

Autel China Headquarters

- **Phone:** +86 (0755) 8614-7779 (Monday-Friday, 9AM-6PM Beijing Time)
- **Email:** support@autel.com
- **Address:** Floor 2, Caihong Keji Building, 36 Hi-tech North Six Road, Songpingshan Community, Xili Sub-district, Nanshan District, Shenzhen City, China
- **Web:** www.autel.com

Autel North America

- **Phone:** 1-855-288-3587 (Monday-Friday, 9AM-6PM Eastern Time)
- **Email:** ussupport@autel.com
- **Address:** 36 Harbor Park Drive, Port Washington, New York, USA 11050
- **Web:** www.autel.com/us

Autel Europe

- **Phone:** +49(0)89 540299608 (Monday-Friday, 9AM-6PM Berlin Time)
- **Email:** support.eu@autel.com
- **Address:** Landsberger Str. 408, 81241 München, Germany
- **Web:** www.autel.eu

Autel APAC

Japan:

- **Phone:** +81-045-548-6282
- **Email:** support.jp@autel.com
- **Address:** 6th Floor, Ari-nadoribiru 3-7-7, Shinyokohama, Kohoku-ku, Yokohama-shi, Kanagawa-ken, 222-0033 Japan
- **Web:** www.autel.com/jp

Australia:

- **Email:** ausupport@autel.com
- **Address:** Unit 5, 25 Veronica Street, Capalaba

Autel IMEA

- **Phone:** +971 585 002709 (in UAE)
- **Email:** imea-support@autel.com
- **Address:** 906-17, Preatoni Tower (Cluster L), Jumeirah Lakes Tower, DMCC, Dubai, UAE
- **Web:** www.autel.com

Autel Latin America

Mexico:

- **Phone:** +52 33 1001 7880 (Spanish in Mexico)
- **Email:** latsupport@autel.com

- **Address:** Avenida Americas 1905, 6B, Colonia Aldrete, Guadalajara, Jalisco, Mexico

Brazil:

- **Email:** brsupport@autel.com
- **Address:** Avenida José de Souza Campos n° 900, sala 32 Nova Campinas Campinas – SP, Brazil
- **Web:** www.autel.com/br

20.4.2 Repair Service

If it becomes necessary to return your device for repair, please download the repair service form from www.autel.com, and fill in the form. The following information must be included:

- Contact name
- Return address
- Telephone number
- Product name
- Complete description of the problem
- Proof-of-purchase for warranty repairs
- Preferred method of payment for non-warranty repairs

 **NOTE**

For non-warranty repairs, payment can be made with Visa, Master Card, or with approved credit terms.

Send the device to your local agent, or to the address below:

Floor 2, Caihong Keji Building, 36 Hi-tech North Six Road, Songpingshan Community, Xili Sub-district, Nanshan District, Shenzhen City, China

20.4.3 Other Services

You can purchase the optional accessories directly from Autel's authorized tool suppliers, and/or your local distributor or agent.

Your purchase order should include the following information:

- Contact information
- Product or part name
- Item description
- Purchase quantity

21 Compliance Information

FCC Compliance

FCC ID: WQ8-DV2141

This device complies with Part 15 of the FCC Rules. Operation is subject to the following two conditions:

1. This device may not cause harmful interference.
2. This device must accept any interference received, including interference that may cause undesired operation.

WARNING

Changes or modifications not expressly approved by the party responsible for compliance would void the user's authority to operate the equipment.

This equipment has been tested and found to comply with the limits for a Class B digital device, pursuant to Part 15 of the FCC Rules. These limits are designed to provide reasonable protection against harmful interference in a residential installation.

This equipment generates uses and can radiate radio frequency energy and, if not installed and used in accordance with the instructions, may cause harmful interference to radio communications. However, there is no guarantee that interference will not occur in a particular installation. If this equipment does cause harmful interference to radio or television reception, which can be determined by turning the equipment off and on, the user is encouraged to try to correct the interference by one or more of the following measures:

- Reorient or relocate the receiving antenna.
- Increase the separation between the equipment and receiver.
- Connect the equipment into an outlet on a circuit different from that to which the receiver is connected.
- Consult the dealer or an experienced radio/TV technician for help.

RF Warning Statement

The device has been evaluated to meet general RF exposure requirement. The device can be used in portable exposure condition without restriction.

This device complies with Industry Canada's licence-exempt RSS standard(s). Operation is subject to the following two conditions:

- (1) This device may not cause interference, and
- (2) This device must accept any interference, including interference that may cause undesired operation of the device.

Le présent appareil est conforme aux CNR d'Industrie Canada applicables aux appareils radio exempts de licence. L'exploitation est autorisée aux deux conditions suivantes:

- (1) l'appareil ne doit pas produire de brouillage, et
- (2) l'utilisateur de l'appareil doit accepter tout brouillage radioélectrique subi, même si le brouillage est susceptible d'en compromettre le fonctionnement.

SAR Statement

This equipment complies with FCC/ISED radiation exposure limits set forth for an uncontrolled environment. End user must follow the specific operating instructions for satisfying RF exposure compliance. The device is designed to meet the requirements for exposure to radio waves established by the Federal Communications Commission (USA/Innovation, Science and Economic Development Canada (ISED)). These requirements set a SAR limit of 1.6 W/kg averaged over one gram of tissue. The highest SAR value reported under this standard during product certification for use when properly worn on the body is 0.829 W/kg.

Cet équipement a été évalué et s'est avéré conforme aux exigences d'exposition aux RF (radiofréquences) du Code de sécurité 6 de Santé Canada pour les conditions d'exposition non contrôlée, qui est de 1.60 W/kg en moyenne sur 1g de tissu. Le DAS (débit d'absorption spécifique) le plus élevé rapporté pour cet appareil est de 0.829 W/kg.

CE Compliance

RED Directive 2014/53/EU.

RoHS Compliance

This device is declared to be in compliance with the European RoHS Directive 2011/65/EU.

22 Warranty

12-Month Limited Warranty

Autel Intelligent Technology Corp., Ltd. (the Company) warrants to the original retail purchaser of this MaxiSys Diagnostic tablet that should this product or any part thereof during normal usage and under normal conditions be proven defective in material or workmanship that results in product failure within twelve (12) months period from the date of purchase, such defect(s) will be repaired, or replaced (with new or rebuilt parts) with Proof of Purchase, at the Company's option, without charge for parts or labor directly related to the defect(s).

NOTE

If the warranty period is inconsistent with local laws and regulations, please comply with the relevant local laws and regulations.

The Company shall not be liable for any incidental or consequential damages arising from the use, misuse, or mounting of the device. Some states do not allow limitation on how long an implied warranty lasts, so the above limitations may not apply to you.

This warranty does not apply to:

- a) Products subjected to abnormal use or conditions, accident, mishandling, neglect, unauthorized alteration, misuse, improper installation or repair or improper storage;
- b) Products whose mechanical serial number or electronic serial number has been removed, altered or defaced;
- c) Damage from exposure to excessive temperatures or extreme environmental conditions;
- d) Damage resulting from connection to, or use of any accessory or other product not approved or authorized by the Company;
- e) Defects in appearance, cosmetic, decorative or structural items such as framing and non-operative parts.
- f) Products damaged from external causes such as fire, dirt, sand, battery leakage, blown fuse, theft or improper usage of any electrical source.

! **IMPORTANT**

All contents of the product may be deleted during the process of repair. You should create a back-up copy of any contents of your product before delivering the product for warranty service.

AUTEL[®]